

FC6A SERIES

MICROSmart

User's Manual



SAFETY PRECAUTIONS

- Read the "FC6A Series MICROSmart User's Manual" to ensure correct operation before starting installation, wiring, operation, maintenance, and inspection of the FC6A Series MICROSmart.
- All FC6A Series MICROSmart modules are manufactured under IDEC's rigorous quality control system, but users must add a backup or failsafe provision to the control system when using the FC6A Series MICROSmart in applications where heavy damage or personal injury may be caused, in case the FC6A Series MICROSmart should fail.
- Care should be taken such that unauthorized access to the FC6A Series MICROSmart does not come from outside network connections. Please note that the Company shall not be liable for any loss, damage or other expenses incurred directly or indirectly by unauthorized access, etc.
- In this manual, safety precautions are categorized in order of importance:



Warning Warning notices are used to emphasize that improper operation may cause severe personal injury or death.

- The FC6A Series MICROSmart is not designed for use in applications requiring a high degree of reliability and safety. The FC6A Series MICROSmart should not be used for such applications.
- When using the FC6A Series MICROSmart in applications (not described above) that require a high degree of reliability in terms of functionality and precision, appropriate measures such as failsafe mechanisms and redundant mechanisms must be taken for the system containing the FC6A Series MICROSmart. The following are specific examples.
 - Emergency stop and interlocking circuits must be configured outside the FC6A Series MICROSmart.
 - If relays or transistors in the FC6A Series MICROSmart output circuits should fail, outputs may remain at on or off state. For output signals which may cause serious accidents, configure monitor circuits outside the FC6A Series MICROSmart.
 - The FC6A Series MICROSmart self-diagnostic function may detect internal circuit or program errors, stop programs, and turn outputs off. Configure circuits so that the system containing the FC6A Series MICROSmart is not jeopardized when outputs turn off.
- Turn off power to the FC6A Series MICROSmart before installation, removal, wiring, maintenance, and inspection of the FC6A Series MICROSmart. Failure to turn power off may cause damage, electrical shocks or fire hazard. If such a circuit is configured inside the FC6A Series MICROSmart, Failure of the FC6A Series MICROSmart may cause disorder of the control system, damage, or accidents.
- Special expertise is required to install, wire, program, and operate the FC6A Series MICROSmart. People without such expertise must not use the FC6A Series MICROSmart.
- Install the FC6A Series MICROSmart according to the instructions described in the "FC6A Series MICROSmart User's Manual". Improper installation will result in falling, failure, or malfunction of the FC6A Series MICROSmart.
- Suitable for use in Class I, Division 2, Groups A,B,C and D Hazardous Locations, or Non-hazardous locations only.
- Warning - Explosion Hazard - Do not disconnect equipment while the circuit is live or unless the area is known to be free of ignitable concentrations.
- Avertissement: Risque d'explosion. Ne pas débrancher tant que le circuit est sous tension, à moins qu'il ne s'agisse d'un emplacement non dangereux
- Warning - Explosion Hazard - Substitution of any components may impair suitability for Class I, Division 2.
- Avertissement: Risque d'explosion. La substitution de composants peut rendre ce matériel inacceptable pour les emplacements de classe I, division 2
- This equipment is an open -type device meant to be installed in an enclosure suitable for the environment that is only accessible with the use of a tool or key.
- Warning - Explosion Hazard - The USB port is not for use in Hazardous Locations.
- Avertissement: Risque d'explosion. Le port USB ne doit pas être utilisé dans des endroits dangereux.



Caution Caution notices are used where inattention might cause personal injury or damage to equipment.

- The FC6A Series MICROSmart is designed for installation in a cabinet. Do not install the FC6A Series MICROSmart outside a cabinet.
- Install the FC6A Series MICROSmart in environments described in the "FC6A Series MICROSmart User's Manual". If the FC6A Series MICROSmart is used in places where the FC6A Series MICROSmart is subjected to high-temperature, high-humidity, condensation, corrosive gases, excessive vibrations, or excessive shocks, then electrical shocks, fire hazard, or malfunction will result.
- The environment for using the FC6A Series MICROSmart is "Pollution degree 2." Use the FC6A Series MICROSmart in environments of pollution degree 2 (according to IEC 60664-1).
- Prevent the FC6A Series MICROSmart from falling while moving or transporting the FC6A Series MICROSmart, otherwise damage or malfunction of the FC6A Series MICROSmart will result.
- Wiring must use lead sizes that are appropriate for the applied voltage and current. Terminal screws must be tightened with the prescribed tightening torque.
- Prevent metal fragments and pieces of wire from dropping inside the FC6A Series MICROSmart housing. Put a cover on the FC6A Series MICROSmart modules during installation and wiring. Ingress of such fragments and chips may cause fire hazard, damage, or malfunction.
- Use a power supply of the rated value. Use of a wrong power supply may cause fire hazard.
- Use an IEC 60127-approved fuse on the power line outside the FC6A Series MICROSmart. This is required when equipment containing the FC6A Series MICROSmart is destined for Europe.
- Use an IEC 60127-approved fuse on the output circuit. This is required when equipment containing the FC6A Series MICROSmart is destined for Europe.
- Use an EU-approved circuit breaker. This is required when equipment containing the FC6A Series MICROSmart is destined for Europe.
- Make sure of safety before starting and stopping the FC6A Series MICROSmart or when operating the FC6A Series MICROSmart to force outputs on or off. Incorrect operation of the FC6A Series MICROSmart may cause machine damage or accidents.
- Do not connect the ground wire directly to the FC6A Series MICROSmart. Connect a protective ground to the cabinet containing the FC6A Series MICROSmart using an M4 or larger screw. This is required when equipment containing the FC6A Series MICROSmart is destined for Europe.
- Do not disassemble, repair, or modify the FC6A Series MICROSmart modules.
- The FC6A Series MICROSmart contains electronic parts and batteries. When disposing of the FC6A Series MICROSmart, do so in accordance with national and local regulations.



ABOUT THIS MANUAL

Thank you for purchasing the FC6A Series MICROSmart manufactured by IDEC Corporation.

This document describes the FC6A Series MICROSmart system configuration, specifications, and installation methods, and it provides descriptions of the various functions.

Read this manual to ensure the correct understanding of the entire functions of the FC6A Series MICROSmart.

IDEC Corporation makes the latest product manual PDFs available on our website at no additional cost.

Please download the latest product manual PDFs from our website.

Product manual PDF download page (www.idec.com/FC6Amanuals)

This manual describes functions, specifications, installation, and operation basics of the FC6A Series MICROSmart. Also included is information on the powerful communications tools of the FC6A Series MICROSmart, as well as troubleshooting procedures.

Chapter 1: General Information

General information about the FC6A Series MICROSmart functions and system configuration examples.

Chapter 2: Product Specifications

Specifications of the FC6A Series MICROSmart.

Chapter 3: Installation and Wiring

Methods and precautions for installing and wiring the FC6A Series MICROSmart.

Chapter 4: Operation Basics

General information about setting up the basic FC6A Series MICROSmart system for programming, starting and stopping the FC6A Series MICROSmart operation, and simple operating procedures. Everything from creating a user program using WindLDR on a computer to monitoring the FC6A Series MICROSmart operation.

Chapter 5: Functions and Settings

Functions of the FC6A Series MICROSmart and convenient functions that you should know about in using the WindLDR (Windows compatible) PLC programming software.

Chapter 6: Devices

Descriptions of the allocations of devices such as inputs, outputs, internal relays, registers, timers, and counters that are used in the basic and advanced instructions, as well as details about the allocations of special internal relays and special data registers.

Chapter 7: HMI Function

Functions that can be used with the HMI module connected to the CPU module and their operating procedures.

Chapter 8: Instructions Reference

List of basic and advanced instructions to program the FC6A Series MICROSmart and descriptions of their functions.

Chapter 9: Analog I/O Modules

Overview of each analog module and their specifications. Module parameters and configuration methods are also described.

Chapter 10: I/O Cartridges

Overview of the cartridges and their specifications. Cartridge parameters and configuration methods are also described.

Chapter 11: SD Memory Card

Functions that can be used with SD memory card connected to the CPU module and their specifications.

Chapter 12: Module Configuration Editor

Description of the module configuration editor that can be used to configure parameters for the modules and cartridges.

Chapter 13: Troubleshooting

Procedures to determine the cause of trouble and actions to be taken when any trouble occurs while operating the FC6A Series MICROSmart.

Appendix

Additional information about type numbers, system software upgrade, and USB driver installation.

Index

Alphabetical listing of key words.

Publication history

December 2015	First Edition
February 2016	Second Edition
April 2016	Third Edition
March 2017	Fourth Edition
August 2017	Fifth Edition
December 2017	Sixth Edition
March 2018	Seventh Edition
November 2018	Eighth Edition
May 2019	Ninth Edition
August 2019	Tenth Edition
December 2019	Eleventh Edition
February 2020	Twelfth Edition
April 2020	Thirteenth Edition
July 2020	Fourteenth Edition
October 2020	Fifteenth Edition
December 2020	Sixteenth Edition

Trademarks

FC6A Series MICROSmart is a trademark of IDEC Corporation.

Regarding laws and compatible standards

This product adheres to the laws and compatible standards of all countries involved, as shown below.

European laws and standards

This product complies with the following EU directives.

- Low Voltage Directive
- RoHS Directive
- RE Directive (FC6A-PC4 only)

To comply with these directives, this product has been designed and evaluated on the basis of the following international and European standard.

- IEC/EN 61131-2: 2007
- EN50581:2012
- EN301 489-1 V2.1.1& EN301 489-17 V2.1.1 (FC6A-PC4 only)

For details on the compatible standards and EU Directives, contact the distributor from which you purchased this product or visit our web site.

North America laws and standards

This product complies with the following standards.

- UL508^{*1}
- UL61010-1^{*1}
- UL61010-2-201^{*1}
- CSA C22.2 No.142^{*1}
- CSA C22.2 No.61010-1^{*1}
- CSA C22.2 No.61010-2-201^{*1}
- ANSI/ISA 12.12.01
- CAN/CSA C22.2 No.213

*1 Certain FC6A Series MICROSmart models are not compatible. For details about applicable standards, please contact IDEC Corporation.

Chinese laws and standards

The FC6A-PC4 complies with the following certification.

- SRRC

Marine standards

This product has been certified by the following classification societies.

(Applications have been submitted for certain models.)

- ABS (American Bureau of Shipping)
- DNV GL (Det Norske Veritas Germanischer Lloyd)
- LR (Lloyd's Register)
- NK (Nippon Kaiji Kyokai)

* This product has not been certified for use on the bridge or deck.

For details on applicable standards and EU directives, please contact the dealer where purchased or check the IDEC website.

IMPORTANT INFORMATION

Under no circumstances shall IDEC Corporation be held liable or responsible for indirect or consequential damages resulting from the use of or the application of IDEC PLC components, individually or in combination with other equipment.

All persons using these components must be willing to accept responsibility for choosing the correct component to suit their application and for choosing an application appropriate for the component, individually or in combination with other equipment.

All diagrams and examples in this manual are for illustrative purposes only. In no way does including these diagrams and examples in this manual constitute a guarantee as to their suitability for any specific application. To test and approve all programs, prior to installation, is the responsibility of the end user.

ABOUT THE WARRANTY OF THE PRODUCTS

1. Warranty Period

The Products are warranted for 3 years from the date of purchase, or from the date of delivery completion.

* Consumable/maintenance parts such as batteries and relays if the operation exceeds 100,000 times are excluded from the 3-year warranty.

2. Extent of Warranty

IDEC CORPORATION is responsible for failures or defects of the Products during the above warranty period, either a replacement part will be provided or the defective parts of the Products will be repaired free of charge. If such failure or defects should occur, please offer them to the distributor, dealer or IDEC CORPORATION with the materials in which the date of purchase is specified.

* The expenses for installation and construction at the time of repair will not be borne.

3. Indemnification

IDEC CORPORATION will not be liable under this Warranty and be indemnified and held harmless from any and all demands, suits, expenses, claims, damages and liabilities in the following event that:

- 1) The Products are used or operated beyond the conditions or environment range as described in catalog, specifications or instruction; or
- 2) The failure or defects of the Products arise from the cause other than the Products; or
- 3) The Products are improved, modified or altered by the party other than IDEC; or
- 4) The failure or defects and damages of the Products arise from the usage of the Product in the way that is not intended; or
- 5) The failure or defects and damages of the Products arise from the cause beyond IDEC's control including, but not limited to, fire, earthquake, flood, lightning, other natural disasters, and acts of God; or
- 6) The failure or defects and damages of the Products arise from the relocation, transportation or drop after you purchase the Products; or
- 7) The failure or defects and damages of the Products arise from improper installation; or
- 8) Maintenance and inspection are not carried out in accordance with instruction.

* Customers assume their own risk in programming products, Company will not be held liable for damages as a result of improper programming.

IDEC CORPORATION DISCLAIMS ALL IMPLIED WARRANTIES OF MERCHANTABILITY AND/OR FITNESS FOR A PARTICULAR USE OR PURPOSE, AS WELL AS LIABILITY FOR INCIDENTAL, SPECIAL, INDIRECT, CONSEQUENTIAL OR OTHER DAMAGES RELATING TO THE PRODUCTS

4. Extent of Service

The price of the Products will not include the fee for any service such as sending technicians and engineers, IDEC CORPORATION will charge you the fee for the following:

- 1) Instruction for installment and visiting for test operation, including, but not limited to creating application software and operation tests; and
- 2) Maintenance and inspection, arrangement and repair; and
- 3) Technical assistance and technical education; and
- 4) Product test and inspection based on you request.

RELATED MANUALS

The following manuals related to the FC6A Series MICROSmart are available. Refer to them in conjunction with this manual.

Type No.	Manual Name	Description
FC9Y-B1722	FC6A Series MICROSmart User's Manual (this manual)	Describes product specifications, installation and wiring instructions, instructions for basic programming operations and special functions, device and instruction lists, and troubleshooting procedures for the FC6A Series MICROSmart.
FC9Y-B1726	FC6A Series MICROSmart Ladder Programming Manual	Describes basic operations for programming with ladders on the FC6A Series MICROSmart, monitoring methods, device and instruction lists, and details of each instruction.
FC9Y-B1730	FC6A Series MICROSmart Communication Manual	Describes specifications related to FC6A Series MICROSmart communication, descriptions of functions, configuration methods, and usage examples.
FC9Y-B1734	FC6A Series MICROSmart PID Module User's Manual	Describes PID module specifications and functions.
WindLDR Help		Describes usage instructions for WindLDR, programming software for the FC6A Series MICROSmart.

NAMES AND ABBREVIATIONS USED IN THIS MANUAL

Model Names

Name Used in This Manual		Type Number, Part Code, or Official Name	
FC6A Series MICROSmart		FC6A Series MICROSmart	
CPU module	All-in-One CPU module	FC6A-C16R1AE, FC6A-C16R1CE, FC6A-C16K1CE, FC6A-C16P1CE, FC6A-C16R1DE, FC6A-C16K1DE, FC6A-C16P1DE, FC6A-C24R1AE, FC6A-C24R1CE, FC6A-C24K1CE, FC6A-C24P1CE, FC6A-C40R1AE, FC6A-C40R1CE, FC6A-C40K1CE, FC6A-C40P1CE, FC6A-C40R1DE, FC6A-C40K1DE, FC6A-C40P1DE	
	CAN J1939 All-in-One CPU module	FC6A-C40R1AEJ, FC6A-C40R1CEJ, FC6A-C40K1CEJ, FC6A-C40P1CEJ, FC6A-C40R1DEJ, FC6A-C40K1DEJ, FC6A-C40P1DEJ	
	Plus CPU module	FC6A-D16R1CEE, FC6A-D16K1CEE, FC6A-D16P1CEE, FC6A-D32K3CEE, FC6A-D32P3CEE, FC6A-D16R4CEE, FC6A-D16K4CEE, FC6A-D16P4CEE, FC6A-D32K4CEE, FC6A-D32P4CEE	
	16-I/O type	FC6A-C16R1AE, FC6A-C16R1CE, FC6A-C16K1CE, FC6A-C16P1CE, FC6A-C16R1DE, FC6A-C16K1DE, FC6A-C16P1DE	
	24-I/O type	FC6A-C24R1AE, FC6A-C24R1CE, FC6A-C24K1CE, FC6A-C24P1CE	
	40-I/O type	FC6A-C40R1AE, FC6A-C40R1CE, FC6A-C40K1CE, FC6A-C40P1CE, FC6A-C40R1DE, FC6A-C40K1DE, FC6A-C40P1DE, FC6A-C40R1AEJ, FC6A-C40R1CEJ, FC6A-C40K1CEJ, FC6A-C40P1CEJ, FC6A-C40R1DEJ, FC6A-C40K1DEJ, FC6A-C40P1DEJ	
	Plus 16-I/O type	FC6A-D16R1CEE, FC6A-D16R4CEE, FC6A-D16K1CEE, FC6A-D16K4CEE, FC6A-D16P1CEE, FC6A-D16P4CEE	
	Plus 32-I/O type	FC6A-D32K3CEE, FC6A-D32P3CEE, FC6A-D32K4CEE, FC6A-D32P4CEE	
	AC power type	FC6A-C16R1AE, FC6A-C24R1AE, FC6A-C40R1AE, FC6A-C40R1AEJ	
	DC power type	24V DC power type	FC6A-C16R1CE, FC6A-C24R1CE, FC6A-C40R1CE, FC6A-C16K1CE, FC6A-C24K1CE, FC6A-C40K1CE, FC6A-C16P1CE, FC6A-C24P1CE, FC6A-C40P1CE, FC6A-C40R1CEJ, FC6A-C40K1CEJ, FC6A-C40P1CEJ, FC6A-D16R1CEE, FC6A-D16K1CEE, FC6A-D16P1CEE, FC6A-D32K3CEE, FC6A-D32P3CEE, FC6A-D16R4CEE, FC6A-D16K4CEE, FC6A-D16P4CEE, FC6A-D32K4CEE, FC6A-D32P4CEE
		12V DC power type	FC6A-C16R1DE, FC6A-C16K1DE, FC6A-C16P1DE, FC6A-C40R1DE, FC6A-C40K1DE, FC6A-C40P1DE, FC6A-C40R1DEJ, FC6A-C40K1DEJ, FC6A-C40P1DEJ
	Relay output type	FC6A-C16R1AE, FC6A-C16R1CE, FC6A-C16R1DE, FC6A-C24R1AE, FC6A-C24R1CE, FC6A-C40R1AE, FC6A-C40R1CE, FC6A-C40R1DE, FC6A-C40R1AEJ, FC6A-C40R1CEJ, FC6A-C40R1DEJ, FC6A-D16R1CEE, FC6A-D16R4CEE	
	Transistor output type	Transistor sink output type	FC6A-C16K1CE, FC6A-C16K1DE, FC6A-C24K1CE, FC6A-C40K1CE, FC6A-C40K1DE, FC6A-C40K1CEJ, FC6A-C40K1DEJ, FC6A-D16K1CEE, FC6A-D16K4CEE, FC6A-D32K3CEE, FC6A-D32K4CEE
		Transistor protection source output type	FC6A-C16P1CE, FC6A-C16P1DE, FC6A-C24P1CE, FC6A-C40P1CE, FC6A-C40P1DE, FC6A-C40P1CEJ, FC6A-C40P1DEJ, FC6A-D16P1CEE, FC6A-D16P4CEE, FC6A-D32P3CEE, FC6A-D32P4CEE
	Expansion module	I/O module	Digital I/O module
Analog I/O module			Analog input module, analog output module, analog mixed I/O module
Communication module		Serial communication module	
		PID module	
Expansion interface module		Expander, remote master, remote slave	
Cartridge	I/O cartridge	Digital I/O cartridge	Digital input cartridge, digital output cartridge
		Analog I/O cartridge	Analog input cartridge, analog output cartridge
	Communication cartridge	RS232C communication cartridge, RS485 communication cartridge, Bluetooth communication cartridge	
WindLDR		WindLDR application software	
USB cable		USB maintenance cable (HG9Z-XCM42), USB Mini-B extension cable (HG9Z-XCE21)	

Name Used in this Manual	WindLDR Operating Procedure
Function area settings	Configuration tab > Function Area Settings group
Monitors	Select Online > Monitor > Start Monitor .
PLC status	Select Online > PLC > Status .
Communication settings	Select Online > Communication > Set Up .
Modbus master request table	On the Configuration tab, in Function Area Settings , click Communication Ports , and in the displayed Function Area Settings dialog box, for Communication Mode under Communication Ports , select Modbus RTU Master or Modbus TCP Client
Application button	The button displayed on the left side of the menu bar. Click to display the menu with New , Save , and Save As , recent projects, WindLDR Options , and Exit WindLDR .

TABLE OF CONTENTS

Safety Precautions.....	Preface-1
About This Manual.....	Preface-3
About the Warranty of the Products.....	Preface-6
Related Manuals.....	Preface-7
Names and Abbreviations Used in this Manual.....	Preface-8

CHAPTER 1:

General Information

About the FC6A Series MICROSmart	1-1
Features	1-8
Special Functions.....	1-9
Communication Functions	1-12
Maintenance Communication.....	1-14
User Communication.....	1-15
Modbus Communication.....	1-15
Data Link Communication	1-16
Ethernet Communication.....	1-17
Operator Interface Connectivity.....	1-18
Using J1939 Communication	1-18
BACnet Communication.....	1-19
EtherNet/IP Communication	1-20
MQTT Communication	1-21

CHAPTER 2:

Product Specifications

Normal Operating Conditions.....	2-1
CPU Module	2-4
Digital I/O Modules.....	2-69
Analog I/O Modules.....	2-105
PID Module.....	2-127
Communication Modules	2-137
Expansion Interface Modules.....	2-143
HMI Module	2-160
Cartridge Base Module.....	2-162
Cartridges.....	2-164
Dimensions	2-177
Rating at Max Surrounding Air Temperature of 55°C/65°C	2-186

CHAPTER 3:

Installation and Wiring

Installation Location	3-1
Assembly Methods.....	3-4
Mounting on DIN Rail	3-10
Input/Output Wiring	3-18
Power Supply and Power Supply Wiring	3-20
Using the Ports	3-24
Using an SD Memory Card	3-30
Replacing the Backup Battery.....	3-34
Connection Restrictions When Expanding the PLC.....	3-37
Terminal Connection.....	3-45
Wiring the CAN J1939 Bus	3-52

CHAPTER 4:

Operation Basics

Start WindLDR	4-1
PLC Selection	4-2
Create Program.....	4-3
Save Project.....	4-8
Simulate Operation.....	4-9
Download Program.....	4-10
Monitor Operation	4-12
Exit WindLDR.....	4-12
Windows Displayed in the Workspace	4-13
Checking the WindLDR Version Number	4-16

	Ladder Program Operation.....	4-17
	Start/Stop Operation	4-18
CHAPTER 5:	<i>Functions and Settings</i>	
	Function List.....	5-1
	Function Area Settings	5-3
	Stop Input and Reset Input	5-5
	Run/Stop Selection at Keep Data Error	5-9
	Run/Stop Selection at Power Up.....	5-10
	Function Switch Configuration.....	5-11
	Memory Backup	5-13
	High-Speed Counter	5-15
	Catch Input	5-35
	Interrupt Input	5-37
	Frequency Measurement	5-40
	Input Filter	5-42
	Analog Voltage Input	5-44
	Analog Potentiometer.....	5-46
	Timer Interrupt.....	5-48
	Forced I/O Function	5-50
	External Memory Devices.....	5-54
	Log Data File Size	5-55
	32-bit Data Storage Setting	5-56
	User Program Protection.....	5-58
	Watchdog Timer Setting	5-60
	Constant Scan Time	5-61
	Daylight Savings Time.....	5-62
	Clock Function	5-63
	Battery Monitor.....	5-66
	USB Boot.....	5-68
	User Program Capacity	5-70
	Online Edit	5-71
CHAPTER 6:	<i>Devices</i>	
	Device Addresses.....	6-1
	Special Internal Relay.....	6-4
	Special Data Register	6-17
CHAPTER 7:	<i>HMI Function</i>	
	HMI Function Overview	7-1
	LCD Settings.....	7-3
	About the Menu Screen	7-5
	Basic Operations.....	7-6
	Switching Run/Stop.....	7-9
	Editing Programs	7-10
	FC6A Series MICROSmart Environment Settings.....	7-12
	Monitoring the FC6A Series MICROSmart.....	7-32
	Checking/Clearing Error Information.....	7-38
	Displaying Arbitrary Messages.....	7-40
	SD Memory Card Maintenance	7-41
	Reading and Writing Recipe Files	7-43
	Uploading/Downloading the User Program.....	7-45
	System Menu Hierarchy Diagram	7-47
	Communication Functions.....	7-48
CHAPTER 8:	<i>Instructions Reference</i>	
	Basic Instruction List	8-1
	Advanced Instruction List	8-3
	Structure of an Advanced Instruction	8-6
	Input Condition for Advanced Instructions	8-6

	Source and Destination Devices.....	8-6
	Using Timer or Counter as Source Device.....	8-6
	Using Timer or Counter as Destination Device.....	8-6
	Data Types for Advanced Instructions.....	8-7
	Discontinuity of Device Areas.....	8-11
	NOP (No Operation).....	8-11
	Device Addressing for Instruction Execution.....	8-12
CHAPTER 9:	Analog I/O Modules	
	Analog I/O Module Overview.....	9-1
	Analog I/O Module Parameter Settings.....	9-4
	Device Allocation.....	9-15
CHAPTER 10:	I/O Cartridges	
	Digital I/O Cartridge.....	10-1
	Analog I/O Cartridge.....	10-7
CHAPTER 11:	SD Memory Card	
	SD Memory Card Overview.....	11-1
	Save Log Data.....	11-7
	Recipe Function.....	11-8
	SD Memory Card Configuration Dialog Box.....	11-22
	Download from SD Memory Card.....	11-27
	Download a ZLD File Uploaded from the PLC (1-Time Upload).....	11-29
	Upload to SD Memory Card.....	11-43
	SD Memory Card Maintenance with Data File Manager.....	11-48
CHAPTER 12:	Module Configuration Editor	
	Module Configuration Editor Overview.....	12-1
	Basic Module Configuration Editor Operations.....	12-3
CHAPTER 13:	Troubleshooting	
	Reading Error Data.....	13-1
	Special Data Registers for Error Information.....	13-3
	General Error Codes.....	13-3
	FC6A Series MICROSmart Operating Status, Output, and ERR LED during Errors.....	13-4
	Error Causes and Actions.....	13-4
	User Program Execution Error.....	13-6
	User Program Execution Error History.....	13-8
	Troubleshooting Diagrams.....	13-10
APPENDIX		
	Type List.....	A-1
	System Software.....	A-9
	Fonts.....	A-12
	Cables.....	A-14
	HMI Screen Transition Diagram.....	A-16
INDEX		

1: GENERAL INFORMATION

Introduction

This chapter describes FC6A Series MICROSmart functions and system configuration examples.

About the FC6A Series MICROSmart

The FC6A Series MICROSmart is a small, All-in-One CPU module or Plus CPU module programmable controller with excellent expandability and a variety of communication functions. The CPU modules are equipped with 16-, 24-, 32-, or 40-I/Os and support either 100 to 240V AC, 24V DC, or 12V DC power supplies.

Expansion modules, cartridges, HMI modules, and other modules can be connected to the CPU module. Inputs, outputs, and communication ports can be expanded according to application.

The FC6A Series MICROSmart can also be linked to various types of external devices with communication functions that include maintenance communication, user communication, and Modbus communication. The FC6A Series MICROSmart is also equipped with functions for high-speed counters, pulses, flow calculation, and data logging functions.

Programs used on the FC6A Series MICROSmart are created with WindLDR, easy-to-use, Windows-compatible ladder programming software. This ladder programming software also supports the FC4A Series and the FC5A Series, so you can use your existing ladder program resources.

Type Numbers

The notation for FC6A Series MICROSmart part numbers is as follows.

For details on the product specifications, see "Product Specifications" on page 2-1.

CPU module

FC6A - C 40 R 1 A E J

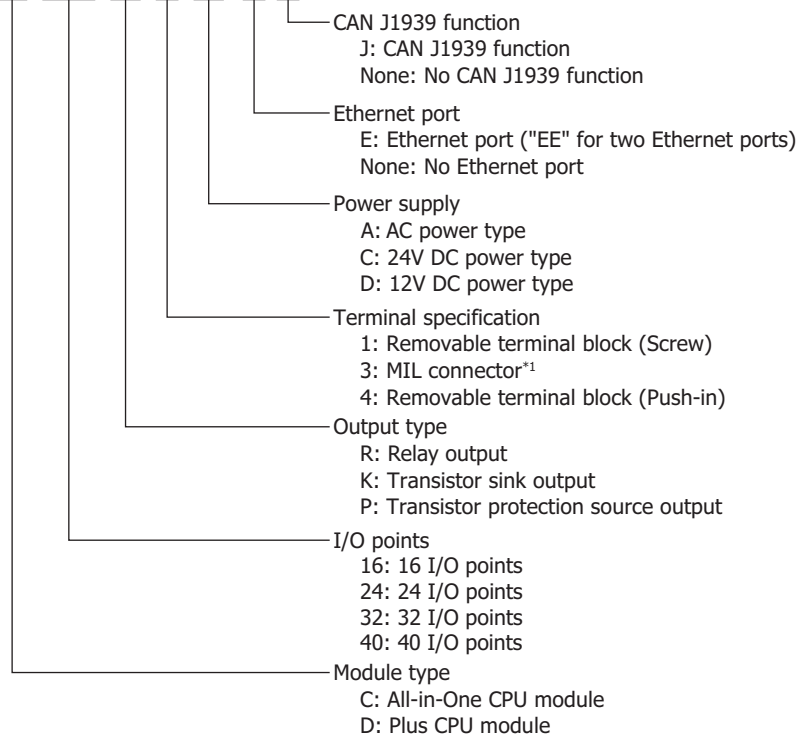

*1 The power supply terminals are a removable terminal block (screw fastened type).

1: GENERAL INFORMATION

HMI module

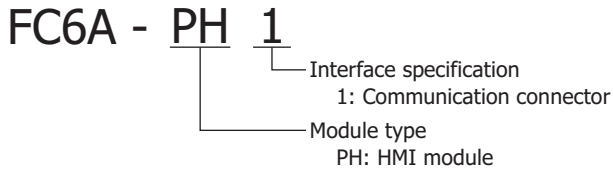

Cartridge base module

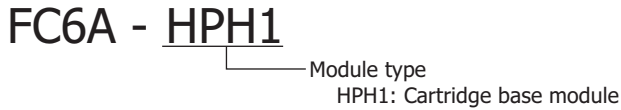

Digital I/O modules

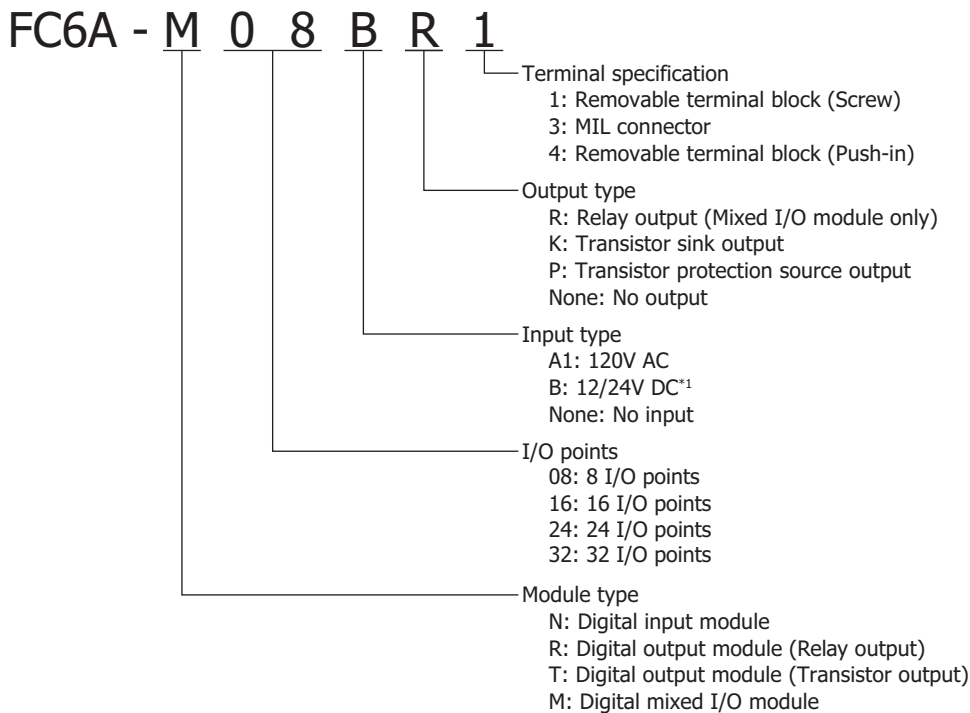

*1 24V DC for products with a version number lower than V400. For details on the version number of modules, see "Checking the Version Number" on page 2-1.

Analog I/O module

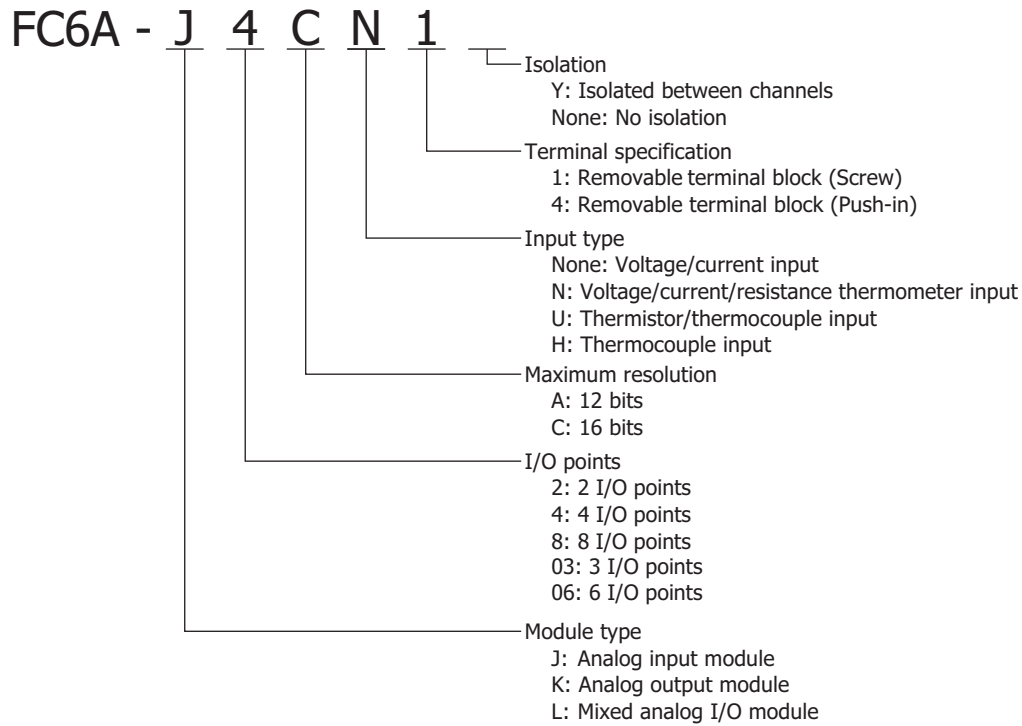

PID module

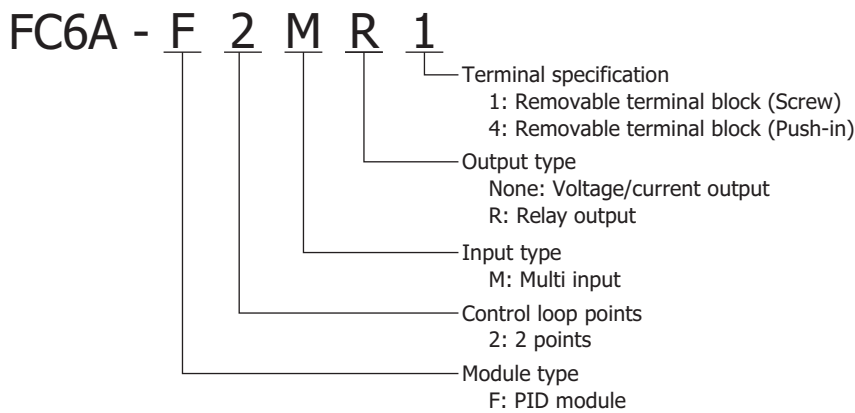

Communication module

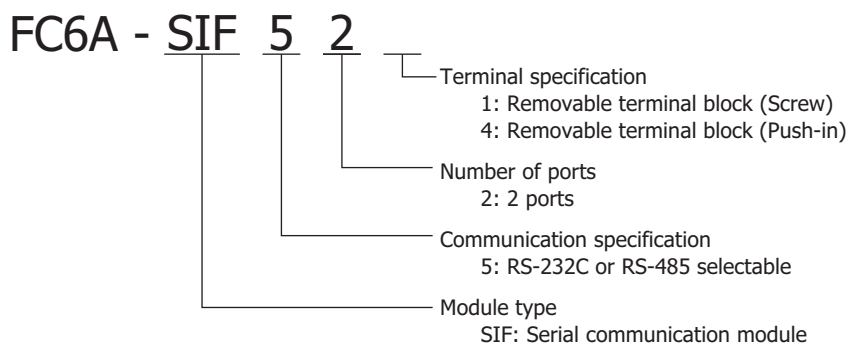

1: GENERAL INFORMATION

Expansion interface module

FC6A - EXM 2

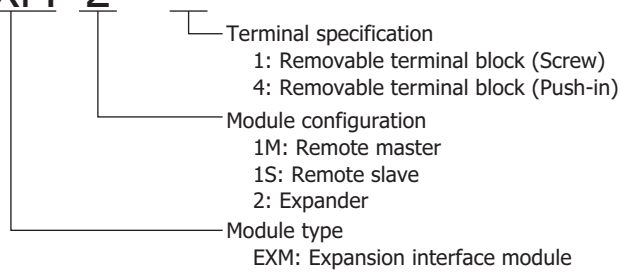

Digital I/O cartridge

FC6A - P N 4

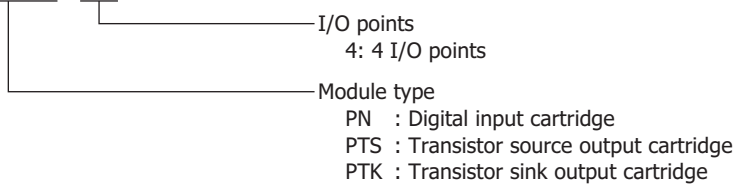

Analog I/O cartridge

FC6A - P K 2 A V

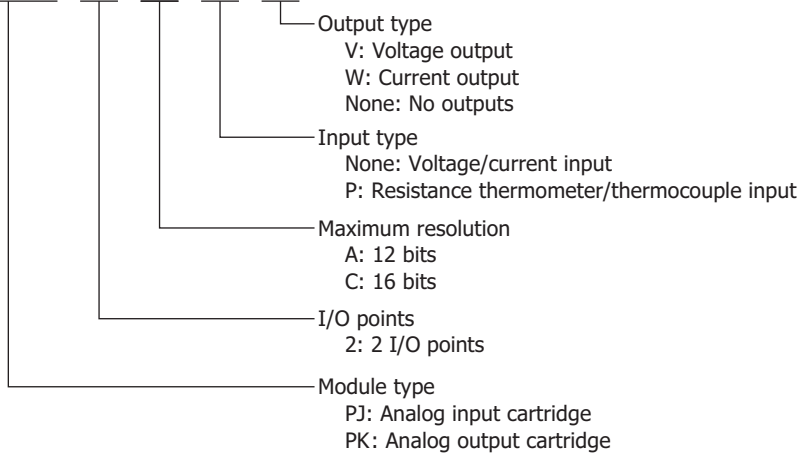

Communication cartridge

FC6A - P C 1

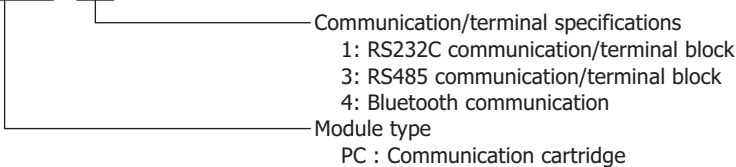

Connector

FC6A - P M T C K 1 1 P N 0 2

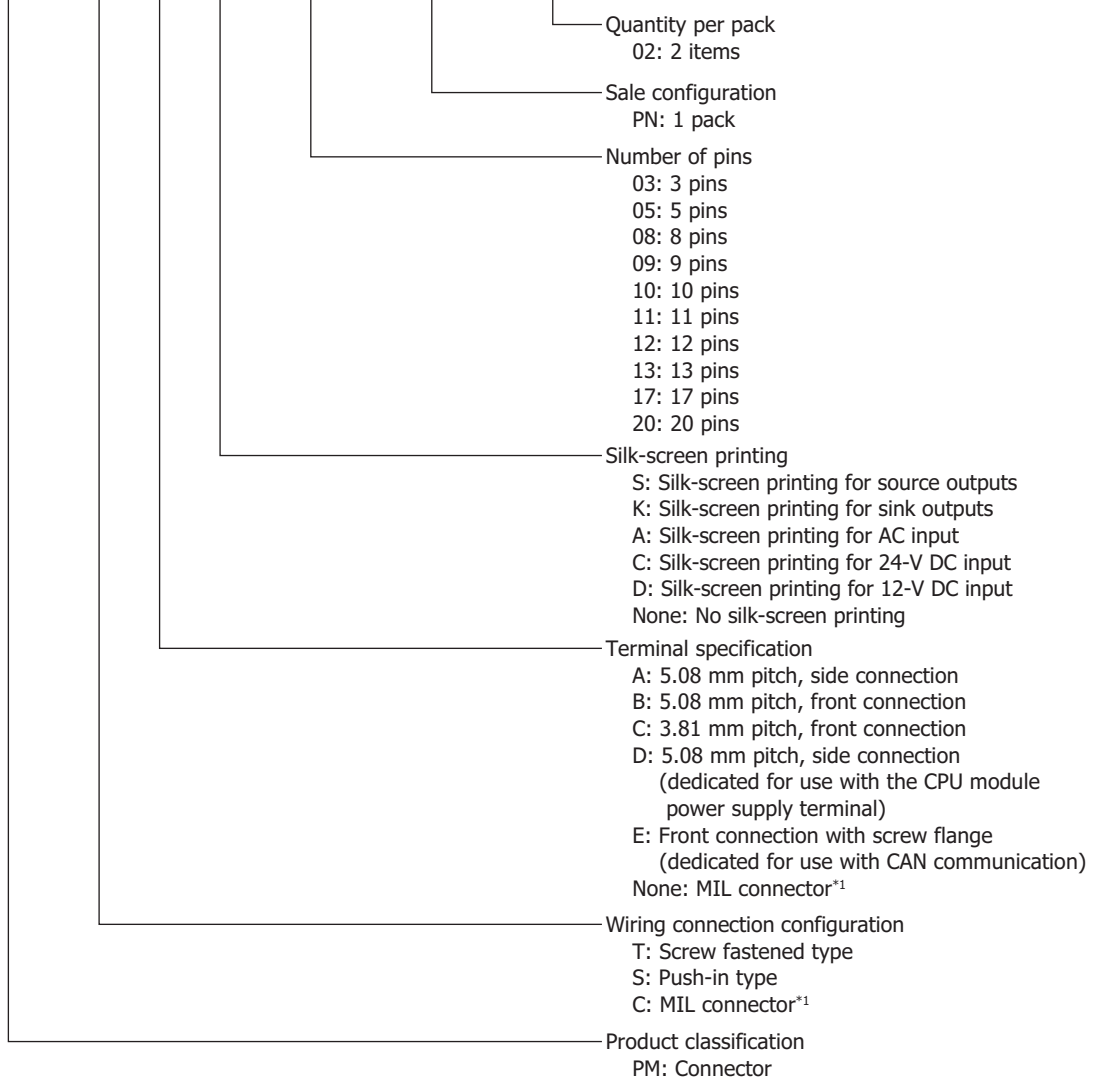

*1 The type number for the MIL connector starts with "FC4A-" instead of "FC6A-".

Cable

FC9Z - H 0 5 0 A 2 0

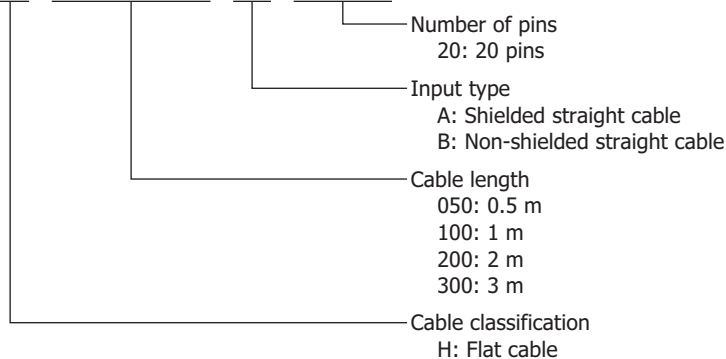

1: GENERAL INFORMATION

Battery holder

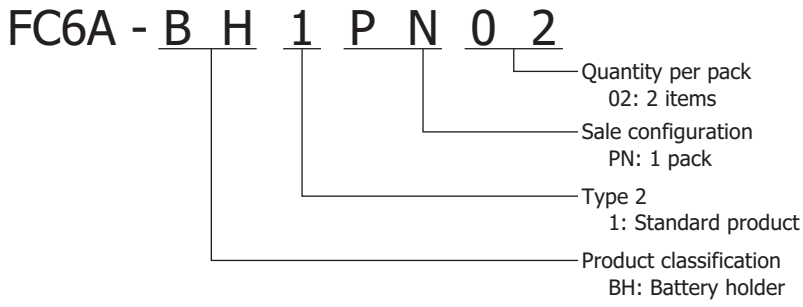

CPU Module Type Numbers and Functions List

Type numbers and functions

Type Number*1	Power Supply	Inputs and Outputs*2	USB Port	Ethernet Port 1	Ethernet Port 2	Number of Cartridge Slots	CAN Port	Serial Port 1	SD Memory Card Slot	Analog Input/Volume																			
FC6A-C**R*AE	100 to 240V AC	16 (404)	Yes	Yes	—	1 (2)	—	Yes	Yes	Yes (1 each)																			
		24 (508)				2 (3)																							
		40 (528)				1 (2)																							
FC6A-C16**CE	24V DC	16 (404)				Yes					Yes	—	—	Yes	Yes	Yes (1 each)													
FC6A-C16**DE	12V DC																												
FC6A-C24**CE	24V DC	24 (508)															Yes	Yes	—	—	Yes	Yes	Yes (1 each)						
FC6A-C40**CE		40 (528)																											
FC6A-C40**DE	12V DC																							40 (528)	Yes	Yes	—	Yes	Yes
FC6A-C40**AEJ	100 to 240V AC																												
FC6A-C40**CEJ	24V DC																												
FC6A-C40**DEJ	12V DC																												
FC6A-D***CEE	24V DC	16 (2,044) 32 (2,060)	Yes	Yes	Yes		0 (3)	—	—	Yes																			

*1 For CPU module type numbers, see "CPU module" on page 1-1.

*2 The value in parentheses () is the number of inputs and outputs when using the expansion interface module and the maximum number of expansion modules are connected.

Options

USB Maintenance Cable
HG9Z-XCM42

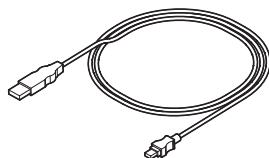

Panel Mount USB Extension Cable
HG9Z-XCE21

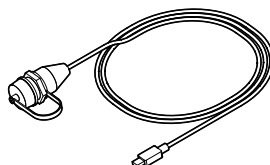

External Device/O/I Communication Cable
FC6A-KC1C

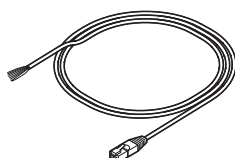

O/I Communication Cable
FC6A-KC2C

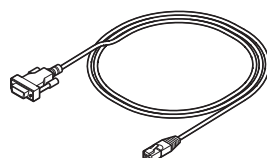

1: GENERAL INFORMATION

Features

This section describes the features of the FC6A Series MICROSmart.

High-speed Instruction Processing

The FC6A Series MICROSmart is capable of high-speed arithmetic processing of basic instructions (LOD) in 0.042 μ s and advanced instructions (MOV) in 0.120 μ s. This improves real time performance during program execution.

Abundant Program Capacity

The FC6A Series MICROSmart has large program capacity.

CPU Module	Program Capacity	
	Standard	When Online Edit Is Used
All-in-One CPU module	384,000 bytes maximum (48,000 steps equivalent)	72,000 bytes maximum (9,000 steps equivalent)
CAN J1939 All-in-One CPU module	640,000 bytes maximum (80,000 steps equivalent)	
Plus CPU module	800,000 bytes maximum (100,000 steps equivalent)	

Note: "Step" is the unit to calculate the program size. One step is 8 bytes, which is the instruction size of contacts or coils.

Online Edit

User programs can be overwritten (run-time programming) and tests can be written while the ladder program is being executed.

Various Communication Functions

The FC6A Series MICROSmart supports the following communications:

- Maintenance communication
- User communication
- Modbus communication
- Datalink communication
- J1939 communication (CAN J1939 All-in-One CPU module only)
- Bluetooth communication
- BACnet communication
- EtherNet/IP communication
- MQTT communication

The following functions using Ethernet are also supported so that a variety of requirements can be achieved, such as remote monitoring or maintenance.

- SNMP
- FTP server/client
- PING
- Send e-mail
- Web server

The FC6A Series MICROSmart can be connected to a variety of devices such as computer, operator interface, and printer.

SD Memory Card

The FC6A Series MICROSmart is equipped with an SD memory card slot. The log data of device values, configuration data, user programs, and system software can be saved to a commercially available SD memory card (32 GB maximum).

Powerful HMI Functions

Device values can be checked and modified on the HMI module's LCD. The LCD can also display the current time, bar charts, messages, and text. The HMI module is equipped with fonts in the following nine languages and can display messages and text in those languages. The HMI module can be operated using the operation buttons. Operations such as switching what is shown on the LCD can be performed using the operation buttons.

Setting Name	Character Set	Supported Languages
European	ISO 8859-1 (Latin-1)	English, German, Italian, Spanish, Dutch (Note), French (Note)
Japanese	Shift-JIS	Japanese (level 1)
Chinese	GB2312	Chinese (simplified)
Cyrillic	ANSI 1251	Russian

Note: Some of the characters cannot be input.

Special Functions

This section describes the functions of the FC6A Series MICROSmart.

I/O Related Functions

Catch Input

The catch input function is used to receive shot pulses (minimum pulse width: 5 μ s) that is shorter than the user program scan time. A maximum of 6 catch inputs can be used.

Note: The scan time is the time duration for executing one cycle of the user program that is cyclically executed.

Input Filter

The input filter is the function to reduce the influence from the bounce or noise on input contacts by adjusting the filter width according to the input signal width. The input filter of 0 ms (no filter) or 3 to 15 ms (1 ms increments) can be configured for individual input.

Interrupt Input

The interrupt input can be used to call an interrupt program to respond to an external input that requires a response faster than the ladder program scan time. A maximum of six interrupt inputs can be used.

Stop and Reset Inputs

The stop input is a function to stop ladder program execution. The reset input is a function to stop ladder program operation and clear device values. Any input terminal on the FC6A Series MICROSmart can be designated as a stop or reset input to control the FC6A Series MICROSmart operation.

Built-in Analog Input Function

This function acquires 0 to 10V DC analog input as a digital value in a special data register. There is one built-in analog input.

Analog Potentiometer Function

This function acquires volume input as a 0 to 1,000 digital value in a special data register according to the position of the volume. There is one analog potentiometer.

Forced I/O

The inputs and outputs of the FC6A Series MICROSmart can be forced on or off. This function can be used to check the I/O wiring or the user program operation.

High-speed I/O Functions

High-speed Counter

This function counts high-speed pulse inputs that cannot be measured in normal user program processing.

Use this function for applications such as positioning control with a rotary encoder or motor control. The FC6A Series MICROSmart can use single-phase high-speed counters and two-phase high-speed counters. A maximum of six single-phase high-speed counters and a maximum of two two-phase high-speed counters (three maximum for Plus CPU module only) can be used simultaneously.

CPU Module		Single-phase High-speed Counter	Two-phase High-speed Counter
All-in-One CPU module/ CAN J1939 All-in-One CPU module	16-I/O type	6 maximum	2 maximum
	24-I/O type		
	40-I/O type		
Plus CPU module	Plus 16-I/O type	3 maximum	
	Plus 32-I/O type		

Example: Controlling a motor by counting two-phase pulse input with a high-speed counter

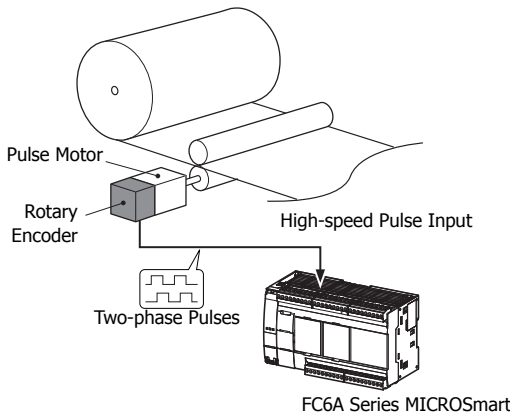

Positioning Control

The FC6A Series MICROSmart can perform positioning control with pulse outputs. The FC6A Series MICROSmart features the PULS instructions that can generate pulse outputs with configured frequency at the fixed pulse width ratio, JOG instructions, pulse-width modulation (PWM) instructions that can generate pulse outputs with configured pulse width ratio at a fixed frequency, RAMP instructions for trapezoidal control, ZRN instructions for zero return operation, and ARAMP instructions that can generate pulse outputs according to a table in which the changes of the frequency are configured.

The FC6A Series MICROSmart also manages coordinates internally and can increment or decrement coordinates according to the number of pulses that were output and the direction.

After confirming the origin using the ZRN instruction, the target position can also be specified by absolute position.

Example: Pulse output by the RAMP instruction

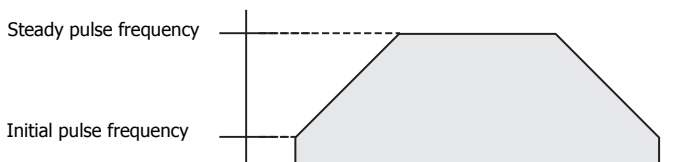

Frequency Measurement

This function measures the frequency of pulses input to an input terminal. The frequencies of a maximum of six inputs can be measured.

Convenient Functions

Calendar/Clock

The FC6A Series MICROSmart features a real-time clock on-board. Using the calendar and clock function, the FC6A Series MICROSmart can operate according to the current date and time. These functions can be used to control a time schedule for lighting or air conditioning equipments.

The FC6A Series MICROSmart also supports daylight savings time and the date and time of the switch can be freely set to allow for use in any region.

User Program Read/Write Protection

The user program in the FC6A Series MICROSmart can be protected against reading and/or writing by including a password in the user program. This function is effective for security of user programs.

"Keep" or "Clear" Designation of FC6A Series MICROSmart Data

This function specifies whether or not to keep FC6A Series MICROSmart device values when there is a power interruption.

Devices that can be specified as kept are internal relays, shift registers, counter current values, and data registers.

RUN/STOP Selection at Startup when "Keep" Data is Lost

When the backup battery is dead, all data to be kept are lost. The user can select whether the FC6A Series MICROSmart starts to run or not to prevent undesirable operation at the startup.

Log Data

Device values of the FC6A Series MICROSmart can be saved as CSV files on the SD memory card. The DLOG instruction saves device values to the SD memory card. The TRACE instruction accumulates device values at each scan and saves them to the SD memory card at the desired timing.

Constant Scan Time

The variations in scan time that occur when the user program is running can be made constant.

Timer Interrupt

The timer interrupt can be used to call an interrupt program at a predetermined interval of time without being affected by the scan time.

Script Function

This function allows programming complicated processing with conditional branching, logical operations, arithmetic operations, and functions as text. Devices can also be read and written. Execute scripts using the SCRPT instruction.

Recipe Function

This function allows the values of device settings to be written to a CSV file to create a recipe file. The values of device settings can be read from a recipe file and reflected in the FC6A Series MICROSmart devices.

Applicable devices are word devices such as timers, counters, and data registers.

SNTP Function

The current time can be acquired from an SNTP server.

USB Boot Function

This function starts the FC6A Series MICROSmart with power supplied from the USB cable.

This allows the user program and system software to be updated.

During USB boot, USB communication and the SD memory card can be used.

PID Control Function

PID control performs temperature control and other types of control using a PID (proportional-integral-derivative) calculation algorithm. The FC6A Series MICROSmart can perform PID control by automatically calculating the optimal PID value using the auto tuning function.

Function Switch

The FC6A Series MICROSmart is equipped with a function switch which can be used to run or stop the user program. The button can be used for any desired purpose by using the on/off status of the function switch stored in the special internal relay.

Communication Functions

The FC6A Series MICROSmart can perform RS232C and RS485 communication using serial port 1. The communication ports can be expanded by using communication cartridges to allow for multiple instances of RS-232C, RS-485, and Bluetooth communication. The Ethernet port is standard equipment to enable communication using Ethernet. The CAN J1939 All-in-One CPU module is equipped with a CAN port to enable J1939 communication.

Communication Functions

Maintenance Communication	Maintenance communication enables you to check the operating status and I/O status of the FC6A Series MICROSmart, to display and change device values, and download and upload user programs using a computer or operator interface.
User Communication	Data can be sent and received by creating commands for external devices (computers, printers, barcode readers, and other devices).
Modbus Communication	Data can be sent and received between communication device that conforms to the Modbus protocol and the FC6A Series MICROSmart.
Data Link Communication	Data can be sent and received between a master station and slave stations by connecting a maximum of 31 MICROSmarts (slave station) to a MICROSmart (master station).
J1939 Communication	The CAN J1939 All-in-One CPU module can send and receive data with communication device that conforms to the SAE-J1939 standard.
BACnet Communication (BACnet/IP)	The Plus CPU module supports BACnet communication using the Internet protocol (IP).
EtherNet/IP communication	The Plus CPU module supports EtherNet/IP (scanner) communication.
MQTT Communication	The Plus CPU module supports MQTT communication.

For details on communication functions, see the "FC6A Series MICROSmart Communication Manual".

Communication Ports

USB Port	Maintenance communication can be performed by connecting the FC6A Series MICROSmart to a computer using this port.
Ethernet Port 1 and 2	The FC6A Series MICROSmart can communicate with Ethernet communication-compatible external devices such as computers and operator interfaces using this port. Maintenance communication, user communication, and Modbus TCP communication are possible. The Plus CPU module can communicate with external devices compatible with BACnet communication and MQTT communication using Ethernet port 1. The Plus CPU module can also communicate with EtherNet/IP-compatible external devices using Ethernet port 2.
HMI-Ethernet Port	This port connects the HMI module to the CPU module and allows the HMI module to be used. The FC6A Series MICROSmart can communicate with Ethernet communication-compatible external devices such as computers and operator interfaces using this port. Maintenance communication is possible.
Serial Port 1	The FC6A Series MICROSmart can communicate with RS232C/RS485 communication-compatible external devices such as computers, operator interfaces, and printers using this port. Maintenance communication, user communication, Modbus RTU communication, and data link communication are possible.
RS232C Communication Cartridge, RS485 Communication Cartridge (option)	The FC6A Series MICROSmart is capable of maintenance communication, user communication, Modbus RTU communication, and data link communication using this port.
Bluetooth Communication Cartridge (option)	The FC6A Series MICROSmart is capable of maintenance communication and user communication using this port.
CAN port	The CAN J1939 All-in-One CPU module is capable of J1939 communication using this port.
Communication Module (option)	The FC6A Series MICROSmart is capable of maintenance communication, user communication, Modbus RTU communication, and data link communication using this port.

Allocations of the Communication Port Numbers

All-in-One CPU module, CAN J1939 All-in-One CPU module, and Plus CPU module support serial communication with the target device. Serial communication is possible with built-in interface or expanded interface of each CPU module. Interfaces supporting the serial communication are as follows:

- All-in-One CPU module : Serial port 1, cartridge slots 1 and 2, communication module ports
- CAN J1939 All-in-One CPU module : Cartridge slots 1 and 2, communication module ports
- Plus CPU module : Cartridge slots 1 to 3, communication module ports

In order to use each interface as communication port, the communication parameters must be configured according to the communication parameters of the target device. Configure the communication parameters in **Communication Ports** tab in the **Function Area Settings** dialog box. The allocation between each interface and communication port is described below.

For details on each setting, refer to chapter 3 "Communication Port Settings" in the "FC6A Series MICROSmart Communication Manual".

■ Ports and Cartridge Slots 1 to 3 on the CPU Module and HMI Module

- : Not equipped with the CPU module.
- No : Cannot be used as the serial communication ports.

CPU Module		Port						Cartridge Slot		
		Serial Port 1	USB Port	Ethernet Port 1	Ethernet Port 2	HMI-Ethernet Port	CAN Port	1	2	3
All-in-One CPU module	16-I/O type	Port 1	No	No	—	No*1	—	Port 2 *2*5	—	—
	24-I/O type								Port 3 *2*5	
	40-I/O type									
CAN J1939 All-in-One CPU module	40-I/O type	—	No	No	—	No	—	Port 2 *2*5	—	
Plus CPU module	Plus 16-I/O type	—	No	No	No	—	—	Port 1 *3*5	Port 2 *3*5	Port 3 *4*5
	Plus 32-I/O type									

- *1 When the HMI module is connected to the CPU module and HMI-Ethernet port is added.
- *2 When a communication cartridge is installed on the cartridge slot.
- *3 When the cartridge base module is connected to the CPU module and a communication cartridge is installed on the cartridge slot.
- *4 When the HMI module is connected to the CPU module and a communication cartridge is installed on the cartridge slot.
- *5 The combination of "Data Bits: 7" and "Parity: None" is not possible.

Notes:

- For the locations of each port and cartridge slot, see "Part Names and Functions" on page 2-4.
- For serial port 1 wiring, see "Other Inputs and Ports" on page 2-47. For communication cartridge wiring, see "Terminal Arrangement and Wiring Examples" on page 2-175.

■ Ports on Communication Modules

CPU Module		Communication Module					
		1st	2nd	3rd	4th	...	15th
All-in-One CPU module	16-I/O type	Port 4, 5	Port 6, 7	Port 8, 9	*1	*1	*1
	24-I/O type						
	40-I/O type						
CAN J1939 All-in-One CPU module	40-I/O type						
Plus CPU module	Plus 16-I/O type				Port 10, 11	...	Port 32, 33
	Plus 32-I/O type						

- *1 Four or more communication modules cannot be connected to the All-in-One CPU module and CAN J1939 All-in-One CPU module.

Maintenance Communication

The maintenance communication of the FC6A Series MICROSmart enables you to check the operating status and I/O status of the FC6A Series MICROSmart, monitor and change device values, and download and upload user programs with the PLC programming software WindLDR installed on a computer. For details on maintenance communication, see the "FC6A Series MICROSmart Communication Manual".

Supported ports*1

USB Port	Serial Port 1	Ethernet Port 1, 2 and HMI-Ethernet Port*2	Communication Cartridge and Communication Module	CAN Port
Yes	Yes	Yes	Yes	No

*1 Depending on the port that will be used, there are differences in maintenance communication functionalities that can be used. For details on the restrictions, see the "FC6A Series MICROSmart Communication Manual".

*2 Only maintenance communication can be used with the HMI-Ethernet port.

■ 1:1 Maintenance Communication System

This example shows a 1:1 maintenance communication system in which a FC6A Series MICROSmart and a computer are connected with USB. The USB maintenance cable (HG9Z-XCM42) is used.

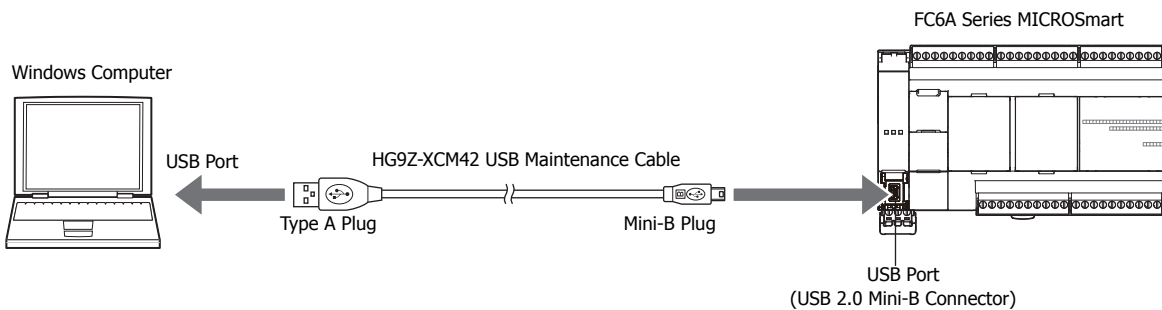

■ 1:N Maintenance Communication System

This example shows a 1:N maintenance communication system in which three FC6A Series MICROSmart and a computer are connected over Ethernet. The Ethernet cables are connected to the Ethernet port 1 of three FC6A Series MICROSmart, and those FC6A Series MICROSmart are connected to the computer via an Ethernet hub.

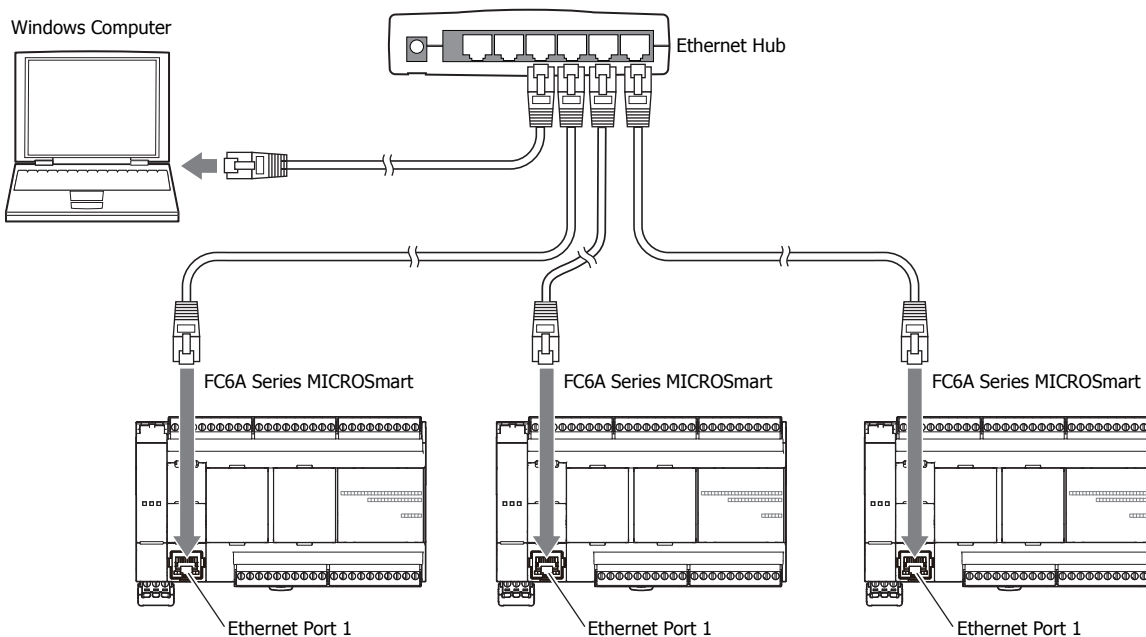

User Communication

The user communication of the FC6A Series MICROSmart enables you to control external devices such as computers, printers, and barcode readers. For details on user communication, see the "FC6A Series MICROSmart Communication Manual".

Supported ports

USB Port	Serial Port 1	Ethernet Port 1 and 2	Communication Cartridge and Communication Module	CAN Port
No	Yes	Yes	Yes	No

■ User Communication Using Serial Port 1

This example shows a system in which a FC6A Series MICROSmart receives the data read by a barcode reader. A barcode reader is connected to port 1 of the FC6A Series MICROSmart.

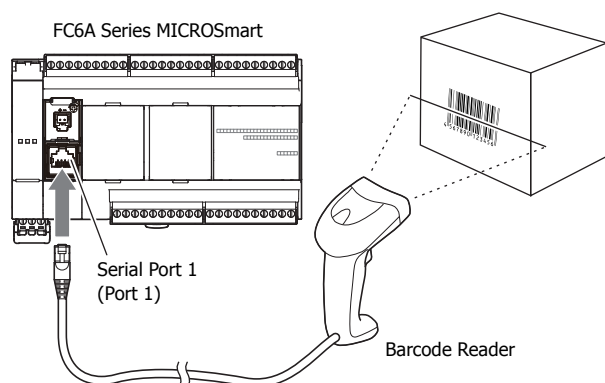

Modbus Communication

The FC6A Series MICROSmart is compliant with Modbus RTU protocol and can be used as either a Modbus communication master or slave. With Modbus communication, the FC6A Series MICROSmart can monitor and modify the data of inverters and temperature controllers.

Ethernet ports 1 and 2 also support the Modbus TCP communication protocol.

For details on Modbus communication, see the "FC6A Series MICROSmart Communication Manual".

Supported ports

USB Port	Serial Port 1	Ethernet Port 1 and 2	Communication Cartridge ^{*1} and Communication Module	CAN Port
No	Yes	Yes	Yes	No

*1 Only the RS-232C communication cartridge and RS-485 communication cartridge are supported.

■ Modbus RTU Communication Using Serial Port 1

This example shows a system in which a FC6A Series MICROSmart is communicating with a temperature controller and an inverter that support Modbus RTU. The A temperature controller is connected to port 1 of the FC6A Series MICROSmart.

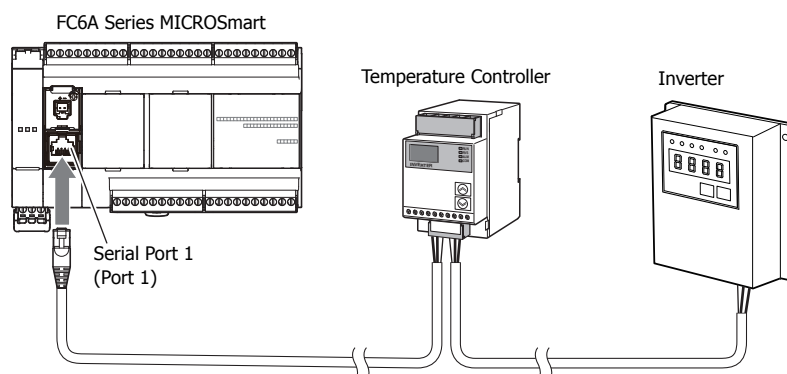

Data Link Communication

The FC6A Series MICROSmart supports data link communication, and it can share data between CPU modules using serial port 1 and cartridge slots. The FC6A Series MICROSmart can also share data with FC5A Series and FC4A Series CPU modules. Configure the settings in WindLDR to enable distributed control of a maximum of 31 CPU modules.

For details about the data link communication, see the "FC6A Series MICROSmart Communication Manual".

Supported ports

USB Port	Serial Port 1	Ethernet Port 1 and 2	Communication Cartridge*1 and Communication Module	CAN Port
No	Yes	No	Yes	No

*1 Only the RS-232C communication cartridge and RS-485 communication cartridge are supported.

■ Data Link Communication Using Serial Port 1

This example shows communication between multiple CPU modules with the FC6A Series MICROSmart as the master station. A slave station CPU module is connected to Serial Port 1 of the FC6A Series MICROSmart.

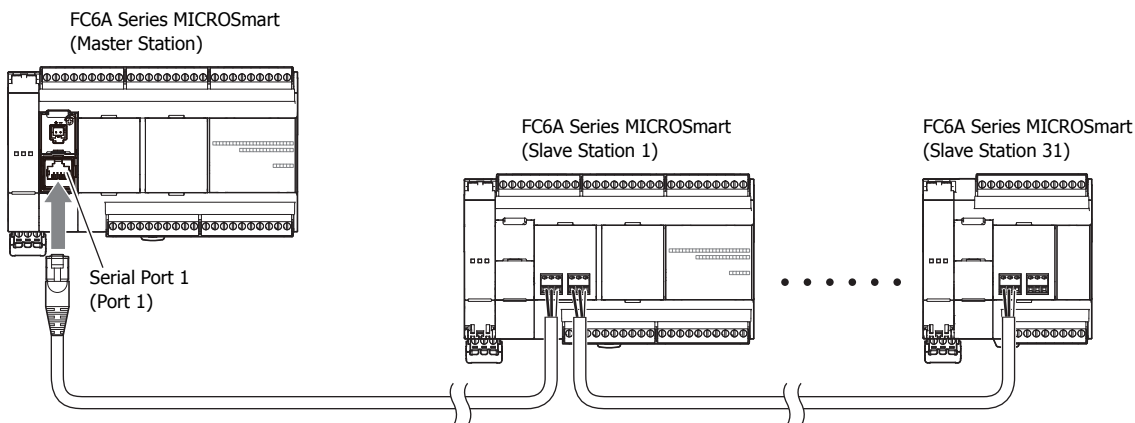

Ethernet Communication

The FC6A Series MICROSmart can be connected to the Ethernet network using Ethernet port 1 and communicate with network devices over Ethernet.

The All-in-One CPU module and CAN J1939 All-in-One CPU module have eight TCP/IP connections and the Plus CPU module has 16 TCP/IP connections that can be used for Ethernet communication. Different communication protocols can be simultaneously used on these connections. Each connection can be configured for maintenance communication server, user communication server/client, or Modbus TCP server/client communication.

Supported ports

USB Port	Serial Port 1	Ethernet Port 1 and 2	Communication Cartridge	CAN Port
No	No	Yes	No	No

■ Ethernet Communication Example

This example shows Ethernet communication between the FC6A Series MICROSmart equipped with Ethernet port 1, an operator interface, and a computer. Among the three connections the FC6A Series MICROSmart has, Connection 1 is configured as maintenance communication server for the computer to communicate with the FC6A Series MICROSmart. Connection 2 is configured as Modbus TCP server for the operator interface to communicate with the FC6A Series MICROSmart. Connection 3 communicates with the barcode reader with the user communication. Connection 4 to connection 8 are not used.

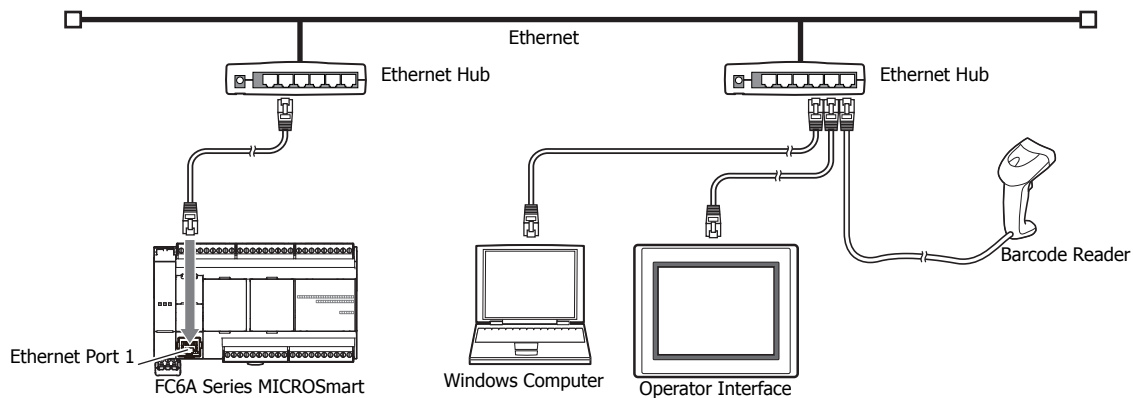

Notes:

- When accessing the FC6A Series MICROSmart over the Internet, adequate security measures for the network to prevent unauthorized access are required. Be sure to consult your network administrator or Internet service provider. IDEC bears no responsibility for damages or problems caused due to security in Ethernet communication.
- Restrict the access to FC6A Series MICROSmart with IP addresses and ports by using appropriate measures such as the firewall.

Operator Interface Connectivity

The FC6A Series MICROSmart can perform maintenance communication with IDEC operator interfaces using Ethernet port 1, serial port 1, and communication cartridge. FC6A Series MICROSmart device values can be monitored and modified by the connected operator interface. An Ethernet cable or an O/I communication cable*1 is used to connect the FC6A Series MICROSmart and the operator interface.

For details on the communication settings, see the "WindO/I-NV2 User's Manual", the "WindO/I-NV3 User's Manual", and the "WindO/I-NV4 User's Manual".

Supported ports

USB Port	Serial Port 1	Ethernet Port 1 and 2	Communication Cartridge*1 and Communication Module	CAN Port
No	Yes	Yes	Yes	No

*1 Only the RS-232C communication cartridge and RS-485 communication cartridge are supported.

■ 1:1 Maintenance Communication Example with an IDEC Operator Interface Using Serial Port 1

This example shows maintenance communication between the FC6A Series MICROSmart and an operator interface, as well as monitoring and changing FC6A Series MICROSmart device values using the operator interface. An IDEC operator interface is connected to serial port 1 of the FC6A Series MICROSmart.

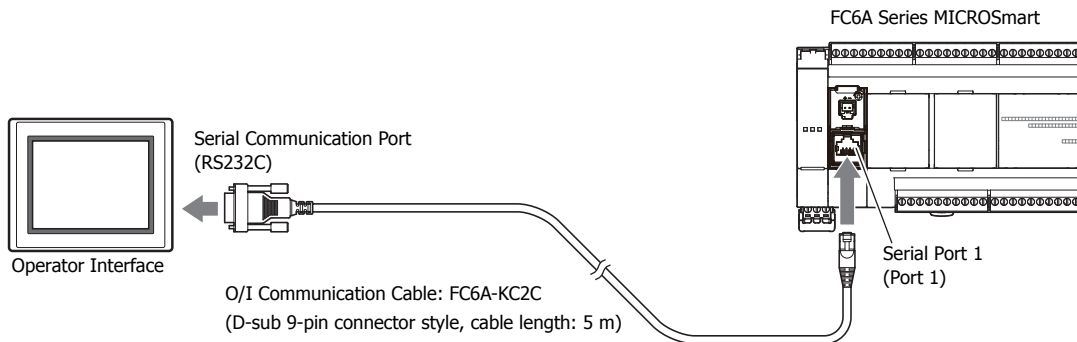

*1 For details on O/I communication cables, see "Cables" on page A-14.

Using J1939 Communication

The CAN J1939 All-in-One CPU module can be connected to a J1939 communication network using the CAN port and it can communicate with other J1939 communication-compatible devices. Messages that conform to the SAE J1939 standard can be sent and received.

For details on J1939 communication, see the "FC6A Series MICROSmart Communication Manual".

Supported ports

USB Port	Serial Port 1	Ethernet Port 1 and 2	Communication Cartridge	CAN Port
No	No	No	No	Yes

■ CAN Port Usage Example

This example shows the FC6A Series MICROSmart communicating with a J1939-compatible engine. The CAN port of the CAN J1939 All-in-One CPU module is connected to the engine.

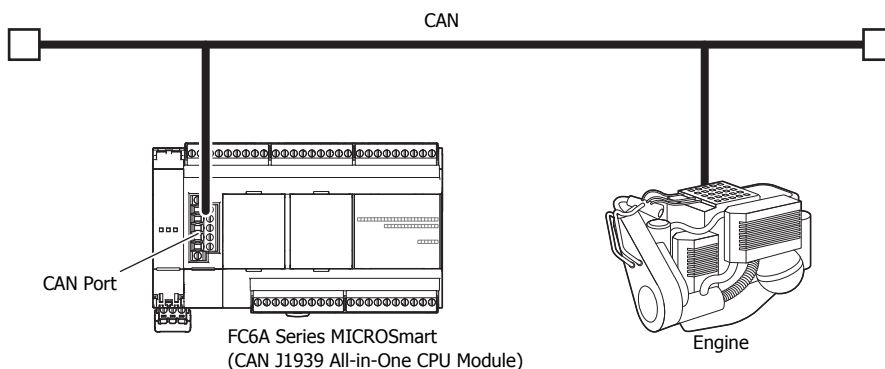

BACnet Communication

The Plus CPU module can be connected to a BACnet/IP network using Ethernet port 1 and communicate with other BACnet communication-compatible external devices. For details on BACnet communications, see the "FC6A Series MICROSmart Communication Manual".

Supported ports

USB Port	Serial Port 1	Ethernet Port 1	Ethernet Port 2	Communication Cartridge and Communication Module	CAN Port
No	No	Yes	No	No	No

■ BACnet Communication Using Ethernet Port 1

This example shows the Plus CPU module aggregating information from Modbus RTU communication-compatible devices, communicating with a BACnet communication-compatible device connected to a BACnet/IP network, and making that information publicly available.

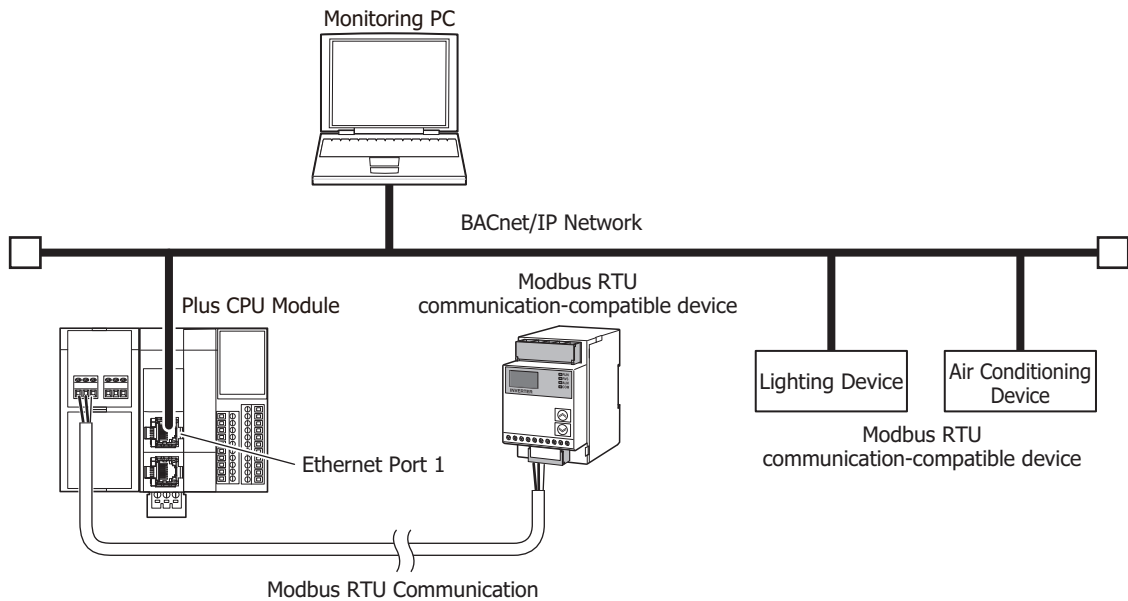

EtherNet/IP Communication

The Plus CPU module can be connected to an Ethernet network using Ethernet port 2 and communicate with other EtherNet/IP communication-compatible external devices. EtherNet/IP communication uses standard Ethernet technologies, which allows networks to be built that include various Ethernet-compatible devices. For details on EtherNet/IP communications, see the "FC6A Series MICROSmart Communication Manual".

Supported ports

USB Port	Serial Port 1	Ethernet Port 1	Ethernet Port 2	Communication Cartridge and Communication Module	CAN Port
No	No	No	Yes	No	No

■ EtherNet/IP Communication Using Ethernet Port 2

This example shows the Plus CPU module communicating with EtherNet/IP communication-compatible devices and controlling those devices.

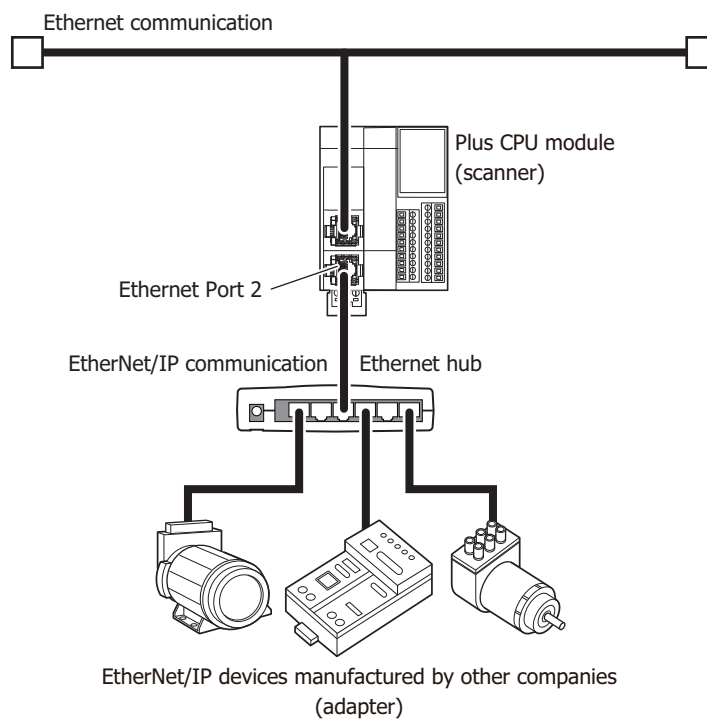

MQTT Communication

The Plus CPU module can communicate with a broker as a client (publisher and subscriber) in MQTT communication using Ethernet port 1. For details on MQTT communications, see the "FC6A Series MICROSmart Communication Manual".

Supported ports

USB Port	Serial Port 1	Ethernet Port 1	Ethernet Port 2	Communication Cartridge and Communication Module	CAN Port
No	No	Yes	No	No	No

■ **MQTT Communication Using Ethernet Port 1**

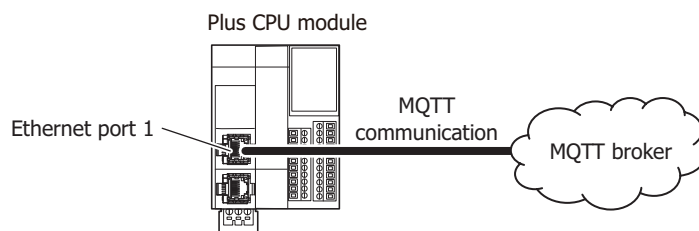

2: PRODUCT SPECIFICATIONS

This chapter describes the part names and specifications of the modules that make up the FC6A Series MICROSmart.

Various types of modules are available for the FC6A Series MICROSmart. These include the CPU modules (All-in-One CPU module, CAN J1939 All-in-One CPU module, and Plus CPU module), digital I/O modules (digital input modules, digital output modules, and digital mixed I/O modules), analog I/O modules (analog input modules, analog output modules, and analog mixed I/O modules), PID modules, communication modules, expansion interface modules (expander and remote master/slave), HMI modules, cartridge base modules, and cartridges (digital I/O cartridges, analog I/O cartridges, and communication cartridges).

Normal Operating Conditions

The normal operating conditions common to the modules are as follows.

Ambient Operating Temperature	-10 to +55°C *1 (no freezing)
Expanded Ambient Operating Temperature	-25 to -10°C, +55 to +65°C*2 (no freezing)
Ambient Storage Temperature	-25 to +70°C (no freezing)
Relative Humidity	10 to 95%, no condensation
Storage Humidity	10 to 95%, no condensation
Pollution Degree	2 (IEC60664-1)
Degree of Protection	IP20 (IEC60529)
Atmosphere	No corrosive gas
Altitude or Air Pressure	1,013 to 795 hPa (0 to 2,000 m) during operation
	1,013 to 701 hPa (0 to 3,000 m) during transport
Installation Location	Inside cabinet
Device Class	Open equipment
Overvoltage Category	II
Vibration Resistance	DIN Rail Mounted
	Panel Mounted
Shock Resistance	5 to 8.4 Hz half amplitude 3.5 mm, 8.4 to 150 Hz, acceleration 9.8 m/s ² (1 G), each direction XYZ, 2 hours (IEC/EN 61131-2)
Shock Resistance	147 m/s ² (15 G), 11 ms, XYZ, 3 axes, 6 directions, 3 times each (IEC 61131-2)
EMC Immunity	IEC/EN61131-2, Zone B compatibility

*1 The HMI module (FC6A-PH1) is 0 to 55°C.

*2 For the status of support for expanded ambient operating temperatures in each product, see "Status of Support for Expanded Ambient Operating Temperatures (-25 to -10°C and 55 to 65°C)" on page 2-2. Certain products are also unable to support expanded ambient operating temperatures, depending on the product version. Check the product version number before using the product in expanded ambient operating temperatures.

The product ratings and usage conditions of certain models will also change if used in expanded ambient operating temperatures. For details, see the following sections.

- "Ambient Temperature, Input Voltage, Output Voltage, I/O Simultaneous ON Ratio" (Pages 2-30, 2-63, 2-71, 2-73, 2-83, 2-85, 2-87, 2-99, 2-100)
- "Ambient Temperature and Analog Input/Output Restrictions" (Page 2-115)
- "Rating at Max Surrounding Air Temperature of 55°C/65°C" (Page 2-186)
- "Connection Restrictions When Expanding the PLC" (Page 3-37)

Checking the Version Number

The version number of each module is listed on the side of the module. The performance and functionality of the analog I/O module will differ by its version, so check the version number before use.

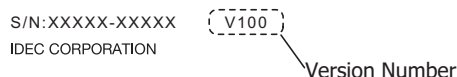

The version number on a CPU module is HV*** and the version number on other modules is V***.

2: PRODUCT SPECIFICATIONS

Status of Support for Expanded Ambient Operating Temperatures (-25 to -10°C and 55 to 65°C)

Name	Type No. *1	Applicability of Expanded Ambient Operating Temperature	
		Status	Version
All-in-One CPU module	FC6A-C*****E	Applicable	HV200 or later
CAN J1939 All-in-One CPU module	FC6A-C40***EJ	Applicable	HV200 or later
Plus CPU module	FC6A-D****CEE	Applicable	HV200 or later
Digital I/O module	FC6A-N08B1/FC6A-N08B4	Applicable	V300 or later
	FC6A-N16B1/FC6A-N16B4		
	FC6A-N16B3		
	FC6A-N32B3		
	FC6A-N08A11/FC6A-N08A14		
	FC6A-R081/FC6A-R084		
	FC6A-R161/FC6A-R164		
	FC6A-T08P1/FC6A-T08P4		
	FC6A-T16P1/FC6A-T16P4		
	FC6A-T16P3		
	FC6A-T32P3		
	FC6A-T08K1/FC6A-T08K4		
	FC6A-T16K1/FC6A-T16K4		
	FC6A-T16K3		
	FC6A-T32K3		
	FC6A-M08BR1/FC6A-M08BR4		
FC6A-M24BR1/FC6A-M24BR4			
Analog I/O module	FC6A-J2C1/FC6A-J2C4	Applicable	V300 or later
	FC6A-J4A1/FC6A-J4A4		
	FC6A-J8A1/FC6A-J8A4		
	FC6A-L03CN1/FC6A-L03CN4		
	FC6A-J4CN1/FC6A-J4CN4		
	FC6A-K2A1/FC6A-K2A4		
	FC6A-J8CU1/FC6A-J8CU4	Not applicable	—
	FC6A-J4CH1Y/FC6A-J4CH4Y		
	FC6A-K4A1/FC6A-K4A4		
	FC6A-L06A1/FC6A-L06A4		
	FC6A-F2M1/FC6A-F2M4		
	FC6A-F2MR1/FC6A-F2MR4		
Expansion interface module	FC6A-EXM1M	Applicable	V200 or later
	FC6A-EXM1S/FC6A-EXM1S4		
	FC6A-EXM2/FC6A-EXM24		
HMI module	FC6A-PH1	Not applicable	—
Cartridge base module	FC6A-HPH1	Not applicable	—
Communication module	FC6A-SIF52/FC6A-SIF524	Applicable	V200 or later
Digital I/O cartridge	FC6A-PTK4	Not applicable	—
	FC6A-PTS4		
	FC6A-PN4		
Analog I/O cartridge	FC6A-PJ2A	Not applicable	—
	FC6A-PJ2CP		
	FC6A-PK2AV		
	FC6A-PK2AW		

Name	Type No. *1	Applicability of Expanded Ambient Operating Temperature	
		Status	Version
Communication cartridge	FC6A-PC1	Not applicable	—
	FC6A-PC3		—
	FC6A-PC4		—
FC6B series	FC6B-C16R1A/FC6B-C16R4A	Applicable	HV200 or later
	FC6B-C16R1C/FC6B-C16R4C		
	FC6B-C16K1C/FC6B-C16K4C		
	FC6B-C16P1C/FC6B-C16P4C		
	FC6B-C24R1A/FC6B-C24R4A		
	FC6B-C24R1C/FC6B-C24R4C		
	FC6B-C24K1C/FC6B-C24K4C		
	FC6B-C24P1C/FC6B-C24P4C		
	FC6B-C40R1A/FC6B-C40R4A		
	FC6B-C40R1C/FC6B-C40R4C		
	FC6B-C40K1C/FC6B-C40K4C		
	FC6B-C40P1C/FC6B-C40P4C		
	FC6B-D16R1C/FC6B-D16R4C		
	FC6B-D16K1C/FC6B-D16K4C		
	FC6B-D16P1C/FC6B-D16P4C		
FC6B-D32K3C/FC6B-D32K4C			
FC6B-D32P3C/FC6B-D32P4C			

*1 For CPU module type numbers, see "CPU module" on page 1-1.

2: PRODUCT SPECIFICATIONS

CPU Module

All-in-One CPU module/CAN J1939 All-in-One CPU module

The All-in-One CPU module is equipped with analog input and serial ports (RS-232C/RS-485). CAN J1939 All-in-One CPU module is equipped with a CAN port.

Part Names and Functions

■ All-in-One CPU module

Example: FC6A-C40R1AE

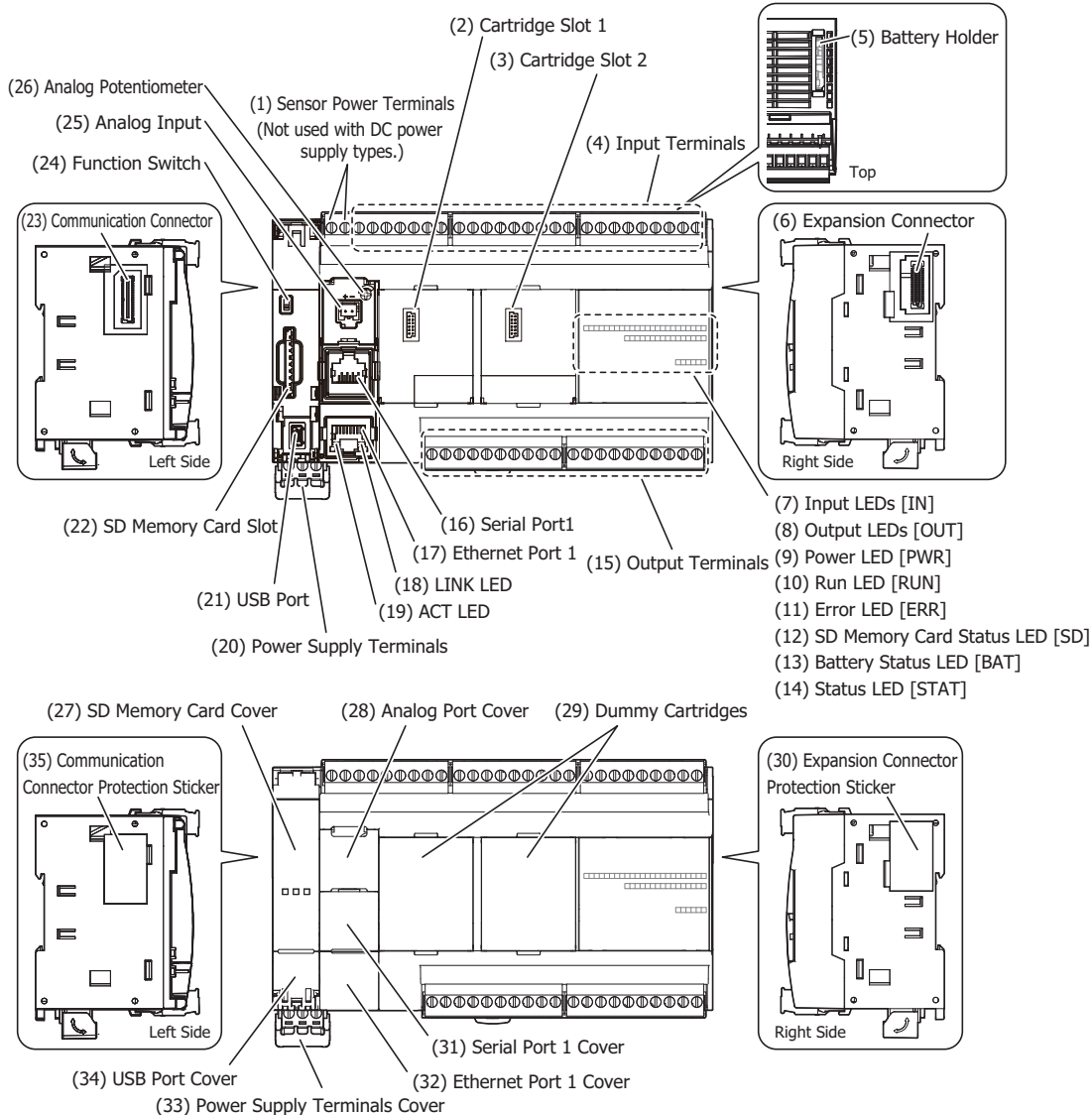

The content in brackets is the LED indicator name on the FC6A Series MICROSmart.

LED Indicators

16-I/O Type

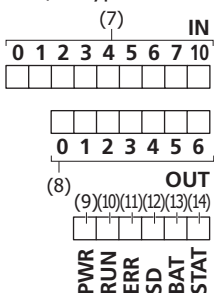

24-I/O Type

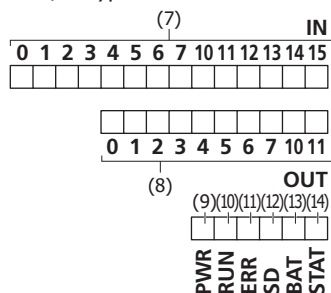

40-I/O Type

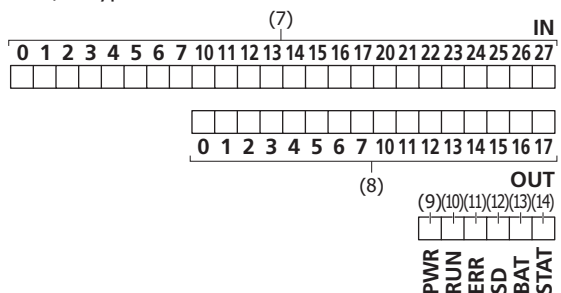

(1) Sensor power terminals (AC power type only)

These terminals supply DC power (24V DC, 250 mA) for a sensor (can also be used as a power supply for inputs).
The DC power type does not use these terminals.

(2) Cartridge Slot 1

This slot is used to connect a digital I/O cartridge, analog I/O cartridge, or communication cartridge.

(3) Cartridge Slot 2 (40-I/O type only)

This slot is used to connect a digital I/O cartridge, analog I/O cartridge, or communication cartridge.
The 16-I/O and 24-I/O types do not have this slot.

(4) Input Terminals

These terminals connect input devices such as push buttons and limit switches. DC inputs are both sinks and sources.

(5) Battery Holder

This holder is for installing the backup battery.

(6) Expansion Connector

This connector is used to connect expansion modules.

(7) Input LEDs [IN]

These LEDs turn on when an input is on. The LED with the corresponding number turns on.

(8) Output LEDs [OUT]

These LEDs turn on when an output is on. The LED with the corresponding number turns on.

(9) Power LED [PWR]

This LED turns on when the power is supplied to the CPU module.

(10) Run LED [RUN]

This LED turns on while the CPU module is running the user program.
This LED flashes when using certain functions while the user program is running.

LED	Status
ON	<ul style="list-style-type: none"> While the CPU module is running the user program
Slow flashing (1 s cycle)	<ul style="list-style-type: none"> When executing the forced I/O function while the user program is running
Quick flashing (100 ms cycle)	<ul style="list-style-type: none"> While the CPU module is in USB boot. When executing the forced I/O function while the user program is stopped

(11) Error LED [ERR]

This LED turns on when an error occurs in the CPU module.

(12) SD Memory Card Status LED [SD]

This LED turns on or flashes when the SD memory card is being read or written.

LED	Status
OFF	<ul style="list-style-type: none"> When the SD memory card is not inserted When an unsupported or unformatted SD memory card was inserted Unmount SD memory card (M8072) is on, so the SD memory card has been unmounted When the FC6A Series MICROSmart power is off
ON	<ul style="list-style-type: none"> The standby state where the SD memory card can be written or read
Slow flashing (1 s cycle)	<ul style="list-style-type: none"> When the FC6A Series MICROSmart is recognizing the SD memory card Unmount SD memory card (M8072) is turned on and the FC6A Series MICROSmart is unmounting the SD memory card (slow flashing, then off)
Quick flashing (100 ms cycle)	<ul style="list-style-type: none"> Reading or writing the SD memory card

(13) Battery Status LED [BAT]

This LED turns on or flashes when the backup battery level is low.

LED	Condition	Battery Status	
Off	Battery voltage (D8056) > 2,300	Normal	Sufficient battery level.
Flashing (1 s cycle)	2,300 ≥ battery voltage (D8056) > 2,000	Warning	Low battery level. Replace the battery.
On	2,000 ≥ battery voltage (D8056)	Dead battery	The battery is almost dead. Or no battery.

2: PRODUCT SPECIFICATIONS

(14) Status LED [STAT]

This LED can be turned on or off in the user program.

(15) Output Terminals

These terminals connect output devices such as electromagnetic switches and solenoid valves. The CPU module is available in the relay output type (240V AC: 2 A, 30V DC: 2 A), the transistor sink output type (0.5 A), and the transistor protection source output type (0.5 A).

(16) Serial Port 1

This port allows serial communication with connected devices that are equipped with a serial interface (RS-232C or RS-485).

(17) Ethernet Port 1

This port allows Ethernet communication with connected devices that are equipped with an Ethernet interface.

(18) LINK LED

This LED is on when a network-compatible device is connected to Ethernet Port 1.

(19) ACT LED

This LED flashes when sending or receiving data while the LINK LED is on.

(20) Power Supply Terminals

These terminals are used to supply power to the CPU module.

The AC power type uses an AC power supply (100 to 240 V).

The DC power type is available as the 24V DC power type and the 12V DC power type.

(21) USB Port

A mini-B type USB 2.0 connector. A USB cable can be attached to the FC6A Series MICROSmart and connected to a PC to download and upload user programs using WindLDR.

(22) SD Memory Card Slot

This slot is for inserting the SD memory card. The SD memory card allows for data logs using the DLOG/TRACE instructions, reading and writing device data, downloads from the SD memory card (user program, system software, web page), and uploads to the SD memory card.

(23) Communication Connector

This connector is used to connect the HMI module.

(24) Function Switch

This switch turns M8073 on or off (default setting: 0 (off)).

You can run or stop the CPU module with this switch by enabling **Run/Stop PLC by Function Switch** in WindLDR (default setting: enabled).

For details on the function switch, see "Function Switch Configuration" on page 5-11.

(25) Analog Input

The connector for the analog input.

(26) Analog Potentiometer

A volume for setting a timer or other device. This allows an analog value used in the user program to be set without the use of an external device.

(27) SD Memory Card Cover

An openable cover that protects the SD memory card and function switch. Open the SD memory card cover when inserting or ejecting the SD memory card and when using the function switch.

(28) Analog Port Cover

A removable cover that protects the analog input and analog potentiometer. When using these, remove the analog port cover.

(29) Dummy Cartridges

Removable dummy cartridges that protect the cartridge slots. Remove the dummy cartridge when connecting a digital I/O cartridge, analog I/O cartridge, or communication cartridge.

(30) Expansion Connector Protection Sticker

This sticker protects the expansion connector. Remove the expansion connector protection sticker when connecting an expansion module.

(31) Serial Port 1 Cover

A removable cover that protects Serial Port 1. When using the serial port, remove the Serial Port 1 cover.

(32) Ethernet Port 1 Cover

A removable cover that protects Ethernet Port 1. When using the Ethernet port, remove the Ethernet Port 1 cover.

(33) Power Supply Terminals Cover

An openable cover that protects the power supply terminals. Open the power supply terminals cover when removing and attaching the power supply terminals.

Note:

The push-in type does not have the power supply terminals cover. The type numbers of the push-in type of All-in-One CPU module are as follows.

FC6A-C16R4AE, FC6A-C16R4CE, FC6A-C16K4CE, FC6A-C16P4CE, FC6A-C16R4DE, FC6A-C16K4DE, FC6A-C16P4DE, FC6A-C24R4AE, FC6A-C24R4CE, FC6A-C24K4CE, FC6A-C24P4CE, FC6A-C40R4AE, FC6A-C40R4CE, FC6A-C40K4CE, FC6A-C40P4CE, FC6A-C40R4DE, FC6A-C40K4DE, FC6A-C40P4DE

(34) USB Port Cover

An openable cover that protects the USB port. When using the USB port, open the USB port cover.

(35) Communication Connector Protection Sticker

This sticker protects the communication connector. Remove the communication connector protection sticker when connecting the HMI module.

■ **CAN J1939 All-in-One CPU module**

Example: FC6A-C40R1AEJ

2: PRODUCT SPECIFICATIONS

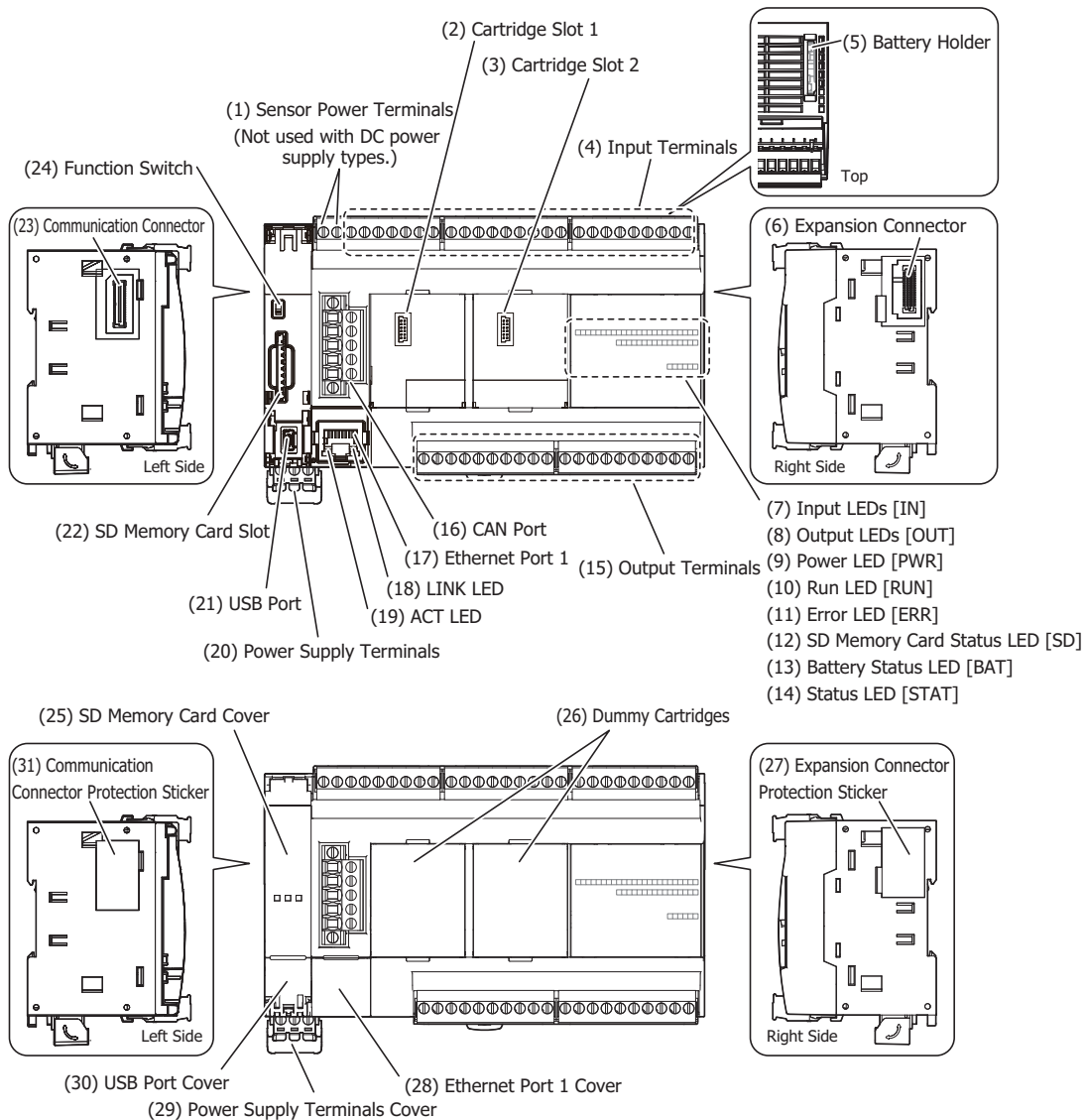

The content in brackets is the LED indicator name on the FC6A Series MICROSmart.

LED Indicators

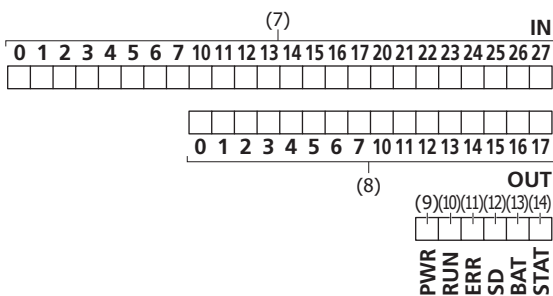

(1) Sensor power terminals (AC power type only)

These terminals supply DC power (24V DC, 250 mA) for a sensor (can also be used as a power supply for inputs).

The DC power type does not use these terminals.

(2) Cartridge Slot 1

This slot is used to connect a digital I/O cartridge, analog I/O cartridge, or communication cartridge.

(3) Cartridge Slot 2

This slot is used to connect a digital I/O cartridge, analog I/O cartridge, or communication cartridge.

(4) Input Terminals

These terminals connect input devices such as push buttons and limit switches. DC inputs are both sinks and sources.

(5) Battery Holder

This holder is for installing the backup battery.

(6) Expansion Connector

This connector is used to connect expansion modules.

(7) Input LEDs [IN]

These LEDs turn on when an input is on. The LED with the corresponding number turns on.

(8) Output LEDs [OUT]

These LEDs turn on when an output is on. The LED with the corresponding number turns on.

(9) Power LED [PWR]

This LED turns on when the power is supplied to the CPU module.

(10) Run LED [RUN]

This LED turns on while the CPU module is running the user program.

This LED flashes when using certain functions while the user program is running.

LED	Status
ON	<ul style="list-style-type: none"> While the CPU module is running the user program
Slow flashing (1 s cycle)	<ul style="list-style-type: none"> When executing the forced I/O function while the user program is running
Quick flashing (100 ms cycle)	<ul style="list-style-type: none"> While the CPU module is in USB boot. When executing the forced I/O function while the user program is stopped

(11) Error LED [ERR]

This LED turns on when an error occurs in the CPU module.

(12) SD Memory Card Status LED [SD]

This LED turns on or flashes when the SD memory card is being read or written.

LED	Status
OFF	<ul style="list-style-type: none"> When the SD memory card is not inserted When an unsupported or unformatted SD memory card was inserted Unmount SD memory card (M8072) is on, so the SD memory card has been unmounted When the FC6A Series MICROSmart power is off
ON	<ul style="list-style-type: none"> The standby state where the SD memory card can be written or read
Slow flashing (1 s cycle)	<ul style="list-style-type: none"> When the FC6A Series MICROSmart is recognizing the SD memory card Unmount SD memory card (M8072) is turned on and the FC6A Series MICROSmart is unmounting the SD memory card (slow flashing, then off)
Quick flashing (100 ms cycle)	<ul style="list-style-type: none"> Reading or writing the SD memory card

(13) Battery Status LED [BAT]

This LED turns on or flashes when the remaining voltage in the backup battery is low.

LED	Condition	Battery Status	
Off	Battery voltage (D8056) > 2,300	Normal	Sufficient battery level.
Flashing (1 s cycle)	2,300 ≥ battery voltage (D8056) > 2,000	Warning	Low battery level. Replace the battery.
On	2,000 ≥ battery voltage (D8056)	Dead battery	The battery is almost dead. Or no battery.

(14) Status LED [STAT]

This LED can be turned on or off in the user program.

(15) Output Terminals

These terminals connect output devices such as electromagnetic switches and solenoid valves. The CPU module is available in the relay output type (240V AC: 2 A, 30V DC: 2 A), the transistor sink output type (0.5 A), and the transistor protection source output type (0.5 A).

(16) CAN Port

This port allows J1939 communication.

(17) Ethernet Port 1

This port allows Ethernet communication with connected devices that are equipped with an Ethernet interface.

2: PRODUCT SPECIFICATIONS

(18) LINK LED

This LED is on when a network-compatible device is connected to Ethernet Port 1.

(19) ACT LED

This LED flashes when sending or receiving data while the LINK LED is on.

(20) Power Supply Terminals

These terminals are used to supply power to the CPU module.

The AC power type uses an AC power supply (100 to 240 V).

The DC power type is available as the 24V DC power type and the 12V DC power type.

(21) USB Port

A mini-B type USB 2.0 connector. A USB cable can be attached to the FC6A Series MICROSmart and connected to a PC to download and upload user programs using WindLDR.

(22) SD Memory Card Slot

This slot is for inserting the SD memory card. This slot is for inserting the SD memory card. The SD memory card allows for data logs using the DLOG/TRACE instructions, reading and writing device data, downloads from the SD memory card (user program, system software, web page), and uploads to the SD memory card.

(23) Communication connector

This connector is used to connect the HMI module.

(24) Function Switch

This switch turns M8073 on or off (default setting: 0 (off)).

You can run or stop the CPU module with this switch by enabling **Run/Stop PLC by Function Switch** in WindLDR (default setting: enabled).

For details on the function switch, see "Function Switch Configuration" on page 5-11.

(25) SD Memory Card Cover

An openable cover that protects the SD memory card and function switch. Open the SD memory card cover when inserting or ejecting the SD memory card and when using the function switch.

(26) Dummy Cartridges

Removable dummy cartridges that protect the cartridge slots. Remove the dummy cartridge when connecting a digital I/O cartridge, analog I/O cartridge, or communication cartridge.

(27) Expansion Connector Protection Sticker

This sticker protects the expansion connector. Remove the expansion connector protection sticker when connecting an expansion module.

(28) Ethernet Port 1 Cover

A removable cover that protects Ethernet Port 1. When using the Ethernet port, remove the Ethernet Port 1 cover.

(29) Power Supply Terminals Cover

An openable cover that protects the power supply terminals. Remove the dummy cartridge when connecting a digital I/O cartridge, analog I/O cartridge, or communication cartridge.

Note:

The push-in type does not have the power supply terminals cover. The type numbers of the push-in type of CAN J1939 All-in-One CPU module are as follows.

FC6A-C40R4AEJ, FC6A-C40R4CEJ, FC6A-C40K4CEJ, FC6A-C40P4CEJ, FC6A-C40R4DEJ, FC6A-C40K4DEJ, FC6A-C40P4DEJ

(30) USB Port Cover

An openable cover that protects the USB port. When using the USB port, open the USB port cover.

(31) Communication Connector Protection Sticker

This sticker protects the communication connector. Remove the communication connector protection sticker when connecting the HMI module.

Power Supply Specifications

■ AC Power Type

Type No.	FC6A-C16R1AE, FC6A-C16R4AE, FC6A-C24R1AE, FC6A-C24R4AE, FC6A-C40R1AE, FC6A-C40R4AE, FC6A-C40R1AEJ, FC6A-C40R4AEJ		
Rated Operating Voltage	100 to 240V AC		
Voltage Fluctuation Range	85 to 264V AC		
Rated Power Frequency	50/60 Hz (47 to 63 Hz)		
Maximum Power Consumption	Standalone	When Maximum Load is Connected	
	FC6A-C16R1AE	33 VA	54 VA
	FC6A-C16R4AE	33 VA	54 VA
	FC6A-C24R1AE	35 VA	61 VA
	FC6A-C24R4AE	35 VA	61 VA
	FC6A-C40R1AE	41 VA	74 VA
	FC6A-C40R4AE	41 VA	74 VA
	FC6A-C40R1AEJ	37 VA	74 VA
FC6A-C40R4AEJ	37 VA	74 VA	
Allowable Momentary Power Interruption	10 ms or longer (when rated power supply voltage)		
Withstand Voltage	Between power and PE terminals: 1,500V AC, 1 minute		
	Between input and PE terminals: 1,500V AC, 1 minute		
	Between relay output and PE terminals: 2,300V AC, 1 minute		
	Between power and input terminals: 1,500V AC, 1 minute		
	Between power and relay output terminals: 2,300V AC, 1 minute		
Insulation Resistance	Between input and relay output terminals: 2,300V AC, 1 minute		
	Between power and PE terminals: 100 MΩ or higher (500V DC insulation resistance tester)		
	Between input and PE terminals: 100 MΩ or higher (500V DC insulation resistance tester)		
	Between relay output and PE terminals: 100 MΩ or higher (500V DC insulation resistance tester)		
	Between power and input terminals: 100 MΩ or higher (500V DC insulation resistance tester)		
Between power and relay output terminals: 100 MΩ or higher (500V DC insulation resistance tester)			
Between input and relay output terminals: 100 MΩ or higher (500V DC insulation resistance tester)			
Inrush Current	40 A maximum		
Isolation	Between power terminal and internal circuit: Transformer isolated		
Ground	D-type ground (Class 3 ground)		
Grounding Wire	See "Recommended Ferrule List" on page 3-46		
Power Supply Wire	See "Recommended Ferrule List" on page 3-46		
Effect of Improper Power Supply Connection	Reverse polarity: Normal operation		
	Improper voltage or frequency: Permanent damage may be caused		
	Improper lead connection: Permanent damage may be caused		
Weight (approx.)	FC6A-C16R1AE	370 g	
	FC6A-C16R4AE	370 g	
	FC6A-C24R1AE	420 g	
	FC6A-C24R4AE	420 g	
	FC6A-C40R1AE	560 g	
	FC6A-C40R4AE	565 g	
	FC6A-C40R1AEJ	560 g	
FC6A-C40R4AEJ	555 g		

2: PRODUCT SPECIFICATIONS

■ 24V DC Power Type

Type No.	FC6A-C16R1CE, FC6A-C16R4CE, FC6A-C16K1CE, FC6A-C16K4CE, FC6A-C16P1CE, FC6A-C16P4CE, FC6A-C24R1CE, FC6A-C24R4CE, FC6A-C24K1CE, FC6A-C24K4CE, FC6A-C24P1CE, FC6A-C24P4CE, FC6A-C40R1CE, FC6A-C40R4CE, FC6A-C40K1CE, FC6A-C40K4CE, FC6A-C40P1CE, FC6A-C40P4CE, FC6A-C40R1CEJ, FC6A-C40R4CEJ, FC6A-C40K1CEJ, FC6A-C40K4CEJ, FC6A-C40P1CEJ, FC6A-C40P4CEJ	
Rated Power Voltage	24V DC	
Voltage Fluctuation Range	20.4 to 28.8V DC (including ripple)	
Maximum Power Consumption	Standalone	When Maximum Load is Connected
	FC6A-C16R1CE	3.36 W (24V DC)
	FC6A-C16R4CE	3.36 W (24V DC)
	FC6A-C16K1CE	4.56 W (24V DC)
	FC6A-C16K4CE	4.56 W (24V DC)
	FC6A-C16P1CE	4.56 W (24V DC)
	FC6A-C16P4CE	4.56 W (24V DC)
	FC6A-C24R1CE	3.72 W (24V DC)
	FC6A-C24R4CE	3.72 W (24V DC)
	FC6A-C24K1CE	4.8 W (24V DC)
	FC6A-C24K4CE	4.8 W (24V DC)
	FC6A-C24P1CE	4.8 W (24V DC)
	FC6A-C24P4CE	4.8 W (24V DC)
	FC6A-C40R1CE	4.68 W (24V DC)
	FC6A-C40R4CE	4.68 W (24V DC)
	FC6A-C40K1CE	4.92 W (24V DC)
	FC6A-C40K4CE	4.92 W (24V DC)
	FC6A-C40P1CE	4.92 W (24V DC)
	FC6A-C40P4CE	4.92 W (24V DC)
	FC6A-C40R1CEJ	4.92 W (24V DC)
	FC6A-C40R4CEJ	4.92 W (24V DC)
	FC6A-C40K1CEJ	4.2 W (24V DC)
	FC6A-C40K4CEJ	4.2 W (24V DC)
	FC6A-C40P1CEJ	4.2 W (24V DC)
	FC6A-C40P4CEJ	4.2 W (24V DC)
Allowable Momentary Power Interruption	10 ms or longer (when rated power supply voltage)	
Withstand Voltage	Between power and FE terminals: 500V AC, 1 minute	
	Between input and FE terminals: 500V AC, 1 minute	
	Between transistor output and FE terminals: 500V AC, 1 minute	
	Between relay output and FE terminals: 2,300V AC, 1 minute	
	Between power and input terminals: 500V AC, 1 minute	
	Between power and transistor output terminals: 500V AC, 1 minute	
	Between power and relay output terminals: 2,300V AC, 1 minute	
	Between input and transistor output terminals: 500V AC, 1 minute	
	Between input and relay output terminals: 2,300V AC, 1 minute	
Insulation Resistance	Between power and FE terminals: 100 MΩ or higher (500V DC insulation resistance tester)	
	Between input and FE terminals: 100 MΩ or higher (500V DC insulation resistance tester)	
	Between transistor output and FE terminals: 100 MΩ or higher (500V DC insulation resistance tester)	
	Between relay output and FE terminals: 100 MΩ or higher (500V DC insulation resistance tester)	
	Between power and input terminals: 100 MΩ or higher (500V DC insulation resistance tester)	
	Between power and transistor output terminals: 100 MΩ or higher (500V DC insulation resistance tester)	
	Between power and relay output terminals: 100 MΩ or higher (500V DC insulation resistance tester)	
	Between input and transistor output terminals: 100 MΩ or higher (500V DC insulation resistance tester)	
Inrush Current	35 A maximum	
Isolation	Between power terminal and internal circuit: Transformer isolated	

Ground	D-type ground (Class 3 ground)
Grounding Wire	See "Recommended Ferrule List" on page 3-46
Power Supply Wire	See "Recommended Ferrule List" on page 3-46
Effect of Improper Power Supply Connection	Reverse polarity: Normal operation
	Improper voltage or frequency: Permanent damage may be caused
	Improper lead connection: Permanent damage may be caused
Weight (approx.)	FC6A-C16R1CE 360 g
	FC6A-C16R4CE 360 g
	FC6A-C16K1CE 340 g
	FC6A-C16K4CE 340 g
	FC6A-C16P1CE 340 g
	FC6A-C16P4CE 340 g
	FC6A-C24R1CE 400 g
	FC6A-C24R4CE 400 g
	FC6A-C24K1CE 380 g
	FC6A-C24K4CE 380 g
	FC6A-C24P1CE 380 g
	FC6A-C24P4CE 380 g
	FC6A-C40R1CE 530 g
	FC6A-C40R4CE 535 g
	FC6A-C40K1CE 480 g
	FC6A-C40K4CE 485 g
	FC6A-C40P1CE 480 g
	FC6A-C40P4CE 485 g
	FC6A-C40R1CEJ 530 g
	FC6A-C40R4CEJ 525 g
	FC6A-C40K1CEJ 480 g
	FC6A-C40K4CEJ 475 g
	FC6A-C40P1CEJ 480 g
FC6A-C40P4CEJ 475 g	

2: PRODUCT SPECIFICATIONS

■ 12V DC Power Type

Type No.	FC6A-C16R1DE, FC6A-C16R4DE, FC6A-C16K1DE, FC6A-C16K4DE, FC6A-C16P1DE, FC6A-C16P4DE, FC6A-C40R1DE, FC6A-C40R4DE, FC6A-C40K1DE, FC6A-C40K4DE, FC6A-C40P1DE, FC6A-C40P4DE, FC6A-C40R1DEJ, FC6A-C40R4DEJ, FC6A-C40K1DEJ, FC6A-C40K4DEJ, FC6A-C40P1DEJ, FC6A-C40P4DEJ	
Rated Power Voltage	12V DC	
Voltage Fluctuation Range	10.2 to 18V DC (including ripple)	
Maximum Power Consumption	Standalone	When Maximum Load is Connected
FC6A-C16R1DE	3.24 W (12V DC)	12.00 W (12V DC)
FC6A-C16R4DE	3.24 W (12V DC)	12.00 W (12V DC)
FC6A-C16K1DE	3.00 W (12V DC)	12.00 W (12V DC)
FC6A-C16K4DE	3.00 W (12V DC)	12.00 W (12V DC)
FC6A-C16P1DE	3.12 W (12V DC)	12.00 W (12V DC)
FC6A-C16P4DE	3.12 W (12V DC)	12.00 W (12V DC)
FC6A-C40R1DE	4.14 W (12V DC)	23.28 W (12V DC)
FC6A-C40R4DE	4.14 W (12V DC)	23.28 W (12V DC)
FC6A-C40K1DE	3.12 W (12V DC)	23.28 W (12V DC)
FC6A-C40K4DE	3.12 W (12V DC)	23.28 W (12V DC)
FC6A-C40P1DE	3.12 W (12V DC)	23.28 W (12V DC)
FC6A-C40P4DE	3.12 W (12V DC)	23.28 W (12V DC)
FC6A-C40R1DEJ	4.08 W (12V DC)	23.28 W (12V DC)
FC6A-C40R4DEJ	4.08 W (12V DC)	23.28 W (12V DC)
FC6A-C40K1DEJ	3.84 W (12V DC)	23.28 W (12V DC)
FC6A-C40K4DEJ	3.84 W (12V DC)	23.28 W (12V DC)
FC6A-C40P1DEJ	3.84 W (12V DC)	23.28 W (12V DC)
FC6A-C40P4DEJ	3.84 W (12V DC)	23.28 W (12V DC)
Allowable Momentary Power Interruption	10 ms or longer (when rated power supply voltage)	
Withstand Voltage	Between power and FE terminals: 500V AC, 1 minute	
	Between input and FE terminals: 500V AC, 1 minute	
	Between transistor output and FE terminals: 500V AC, 1 minute	
	Between relay output and FE terminals: 2,300V AC, 1 minute	
	Between power and input terminals: 500V AC, 1 minute	
	Between power and transistor output terminals: 500V AC, 1 minute	
	Between power and relay output terminals: 2,300V AC, 1 minute	
	Between input and transistor output terminals: 500V AC, 1 minute	
Insulation Resistance	Between power and FE terminals: 100 MΩ or higher (500V DC insulation resistance tester)	
	Between input and FE terminals: 100 MΩ or higher (500V DC insulation resistance tester)	
	Between transistor output and FE terminals: 100 MΩ or higher (500V DC insulation resistance tester)	
	Between relay output and FE terminals: 100 MΩ or higher (500V DC insulation resistance tester)	
	Between power and input terminals: 100 MΩ or higher (500V DC insulation resistance tester)	
	Between power and transistor output terminals: 100 MΩ or higher (500V DC insulation resistance tester)	
	Between power and relay output terminals: 100 MΩ or higher (500V DC insulation resistance tester)	
	Between input and transistor output terminals: 100 MΩ or higher (500V DC insulation resistance tester)	
Inrush Current	35 A maximum	
Isolation	Between power terminal and internal circuit: Transformer isolated	
Ground	D-type ground (Class 3 ground)	
Grounding Wire	See "Recommended Ferrule List" on page 3-46	
Power Supply Wire	See "Recommended Ferrule List" on page 3-46	
Effect of Improper Power Supply Connection	Reverse polarity: Normal operation	
	Improper voltage or frequency: Permanent damage may be caused	
	Improper lead connection: Permanent damage may be caused	

Weight (approx.)	FC6A-C16R1DE	350 g
	FC6A-C16R4DE	350 g
	FC6A-C16K1DE	340 g
	FC6A-C16K4DE	340 g
	FC6A-C16P1DE	340 g
	FC6A-C16P4DE	340 g
	FC6A-C40R1DE	560 g
	FC6A-C40R4DE	565 g
	FC6A-C40K1DE	530 g
	FC6A-C40K4DE	535 g
	FC6A-C40P1DE	530 g
	FC6A-C40P4DE	535 g
	FC6A-C40R1DEJ	560 g
	FC6A-C40R4DEJ	555 g
	FC6A-C40K1DEJ	530 g
	FC6A-C40K4DEJ	525 g
	FC6A-C40P1DEJ	530 g
	FC6A-C40P4DEJ	525 g

2: PRODUCT SPECIFICATIONS

Function Specifications

■ CPU Module Performance

Type No.	FC6A-C16R1AE FC6A-C16R4AE FC6A-C16R1CE FC6A-C16R4CE FC6A-C16K1CE FC6A-C16K4CE FC6A-C16P1CE FC6A-C16P4CE FC6A-C16R1DE FC6A-C16R4DE FC6A-C16K1DE FC6A-C16K4DE FC6A-C16P1DE FC6A-C16P4DE	FC6A-C24R1AE FC6A-C24R4AE FC6A-C24R1CE FC6A-C24R4CE FC6A-C24K1CE FC6A-C24K4CE FC6A-C24P1CE FC6A-C24P4CE	FC6A-C40R1AE FC6A-C40R4AE FC6A-C40R1CE FC6A-C40R4CE FC6A-C40K1CE FC6A-C40K4CE FC6A-C40P1CE FC6A-C40P4CE FC6A-C40R1DE FC6A-C40R4DE FC6A-C40K1DE FC6A-C40K4DE FC6A-C40P1DE FC6A-C40P4DE	FC6A-C40R1AEJ FC6A-C40R4AEJ FC6A-C40R1CEJ FC6A-C40R4CEJ FC6A-C40K1CEJ FC6A-C40K4CEJ FC6A-C40P1CEJ FC6A-C40P4CEJ FC6A-C40R1DEJ FC6A-C40R4DEJ FC6A-C40K1DEJ FC6A-C40K4DEJ FC6A-C40P1DEJ FC6A-C40P4DEJ		
Program Capacity*1	Program Data	72,000 bytes (9,000 steps) * Writable during run-time				
		384,000 bytes (48,000 steps) * Not writable during run-time	640,000 bytes (80,000 steps) * Not writable during run-time			
	Comment Data	256,000 bytes	256,000 bytes			
I/O Expansion	Basic Expansion	4	7	7	7	
	Expansion Interface	8	8	8	8	
	Cartridges*2 *3	2	2	3	3	
I/O Points	Basic	Input	9	14	24	24
		Output	7	10	16	16
	Basic Expansion *4	128	224	224	224	
	Expansion Interface *5	256	256	256	256	
	Cartridges*2 *3	8	8	12	12	
User Program Download	1,000 times					
Control System	Stored program system					
Instructions	Basic Instructions	42 types				
	Advanced Instructions	124 types				
Processing Speed	Basic Instruction	0.042 ms/1,000 steps				
	END Processing	1 ms				
Internal Relay	12,400					
Shift Register	256					
Data Register	54,000					
Counter (adding, reversible)	512					
Timer (1 ms, 10 ms, 100 ms, 1 s)	1,024					

*1 1 step is equivalent to 8 bytes.

*2 As given below, certain digital I/O cartridges cannot be used in cartridge slot 3 depending on the configuration of expansion modules.

Limitations on Using Digital I/O Cartridges

Configuration of Expansion Modules	Digital I/O Cartridges That Cannot Be Used in Cartridge Slot 3
FC6A-N32B3×15	FC6A-PN4
FC6A-T32K3 and FC6A-T32P3×15	FC6A-PTK4, FC6A-PTS4

*3 A maximum of two or three cartridges can be used by connecting the HMI module.

*4 There are limitations on the maximum number of outputs that can be simultaneously turned on.

For details, see "Connection Restrictions When Expanding the PLC" on page 3-37.

*5 The maximum number of expansion modules that can be connected can be increased by using the expansion interface module. For details, see "Expansion Interface Modules" on page 2-143.

Backup Function

Backup Data	RAM (internal relays, shift registers, counters, data registers) ^{*1} , clock
Backup Battery	Lithium ion primary cell (A battery is included with the product. The model of battery to be included with the product cannot be specified.) Panasonic: BR2032/CR2032A/CR2032B, Murata: CR2032X/CR2032W
Battery Life	Guaranteed 1 year, replacement recommended every 4 years (+25°C) ^{*2}
Replaceability	Replace within 1 minute after power off (recommended) ^{*3}

*1 To prepare for when the battery dies, the contents of RAM (internal relays, shift registers, counters, and data registers) can be saved to non-volatile memory. For how to save the contents of RAM, see "SD Memory Card" on page 11-1.

*2 The battery is primarily consumed by backup current while unpowered. However, the ambient environment (temperature and humidity) while unpowered and powered also affects consumption. In particular, battery life is greatly reduced in a high-temperature and high-humidity environment, so replacement is recommended every year when the effect of the ambient environment (temperature and humidity) while unpowered and powered is included.

*3 Replacement while powered and replacement while power is supplied from the USB bus are also possible. For the replacement method, see "Replacing the Backup Battery" on page 3-34.

Clock Function

Accuracy	±30 seconds/month at 25°C
-----------------	---------------------------

Self-diagnostic Functions

- Keep data
- User program (ROM) CRC check
- Timer/counter preset value change check
- User program syntax check
- User program execution check
- Watchdog timer check
- User program download check
- Power failure
- Clock error
- Data link connection check
- Expansion bus initialization check
- System check
- SD memory card transfer check
- SD memory card access check

Input Filter

0 ms (no filter), 3 to 15 ms selectable (in 1 ms increments)

Catch Input/Interrupt Input

High-speed 4 Points (I0, I1, I6, I7)	Minimum turn on pulse width:	5 μs
	Minimum turn off pulse width:	5 μs
Medium-speed 2 Points (I3, I4)	Minimum turn on pulse width:	35 μs
	Minimum turn off pulse width:	35 μs

High-speed Counter

Maximum Counter Frequency and Points	Single-phase, two-phase common:	100 kHz (single-phase 4 points max, two-phase 2 points max)
	Single-phase dedicated:	5 kHz (2 points)
Count Range	Single-phase, two-phase common:	0 to 4,294,967,295 (32 bits)
	Single-phase dedicated:	0 to 4,294,967,295 (32 bits)
Operation Mode	Rotary encoder mode, adding counter mode, frequency measurement mode	

2: PRODUCT SPECIFICATIONS

Pulse Output (Transistor Output Type Only)

Part No.	FC6A-C16K1CE FC6A-C16K4CE FC6A-C16P1CE FC6A-C16P4CE FC6A-C16K1DE FC6A-C16K4DE FC6A-C16P1DE FC6A-C16P4DE	FC6A-C24K1CE FC6A-C24K4CE FC6A-C24P1CE FC6A-C24P4CE	FC6A-C40K1CE FC6A-C40K4CE FC6A-C40P1CE FC6A-C40P4CE FC6A-C40K1DE FC6A-C40K4DE FC6A-C40P1DE FC6A-C40P4DE	FC6A-C40K1CEJ FC6A-C40K4CEJ FC6A-C40P1CEJ FC6A-C40P4CEJ FC6A-C40K1DEJ FC6A-C40K4DEJ FC6A-C40P1DEJ FC6A-C40P4DEJ
Points	4			
Maximum output pulse frequency	Q0,Q1: 100kHz Q2,Q3: 5kHz		Q0,Q2,Q4,Q6: 100kHz	
Reversible control	Single-pulse output mode: 2axis (Q0-Q3) Dual-pulse output mode: 1axis (Q0-Q1)		Single-pulse output mode: 4axis (Q0-Q7) Dual-pulse output mode: 4axis (Q0-Q7)	
PWM output	Duty cycle: 0.1 to 100.0 (increments of 0.1%) Output pulse frequency: 15 to 5,000 (increments of 1Hz) : 4 points(Q0-Q3) *Q0,Q1:Adjust min. 5μs as ON time, and min. 15μs as OFF time. *Q2,Q3:Adjust min. 100μs as ON/OFF time .		Duty cycle: 0.1 to 100.0 (increments of 0.1%) Output pulse frequency: 15 to 5,000 (increments of 1Hz) : 4 points(Q0,Q2,Q4,Q6) *Adjust min. 5μs as ON time, and min. 15μs as OFF time.	

Function Switch

Points	1 (2 position slide switch)
Function	Program run/stop The function can be set in the function area settings (default setting: enabled).

Run/Stop Methods

- Power on/off
- WindLDR RUN/STOP command
- Function switch operation
- Special internal relay (M8000) operation
- Operation of stop input and reset input

Sensor External Output Power (AC Power Type Only)*1

Type No.	FC6A-C16R1AE, FC6A-C16R4AE, FC6A-C24R1AE, FC6A-C24R4AE, FC6A-C40R1AE, FC6A-C40R4AE, FC6A-C40R1AEJ, FC6A-C40R4AEJ
Output Voltage/Current	24 V (+10%, -15%)/250 mA (however, capacitive load is 2,500 μF or lower)
Overload Detection	Not possible (an overcurrent protection circuit is built in, but there is a risk of damage from a long term short circuit.)
Isolation between Internal Circuit	Isolated

*1 When the FC6A Series MICROSmart is used in expanded ambient operating temperatures (-25 to -10°C and 55 to 65°C), sensor external output power cannot be used.

USB Port

Points	1
Communication Type	USB2.0 Full speed, CDC class
Communication Functions	Capable of maintenance communication with a PC
Connector	USB mini-B
Isolation between Internal Circuit	Not isolated
Available Function when FC6A is Powered by USB	Downloading/uploading user programs, downloading system software, data file manager

Ethernet Port 1

Points	1 (When the HMI module is connected, this can be expanded by 1 point with the Ethernet port that has the web server function.)
Communication Type	IEEE 802.3 compliant
Communication Speed	10BASE-T, 100BASE-TX
Number of Connections	8
Communication Functions	Maintenance communication, user communication, Modbus TCP server/client
Connector	RJ45 (Auto MDI/MDI-X compatible)
Cable	CAT 5 or higher, STP
Maximum Cable Length	100 m
Isolation between Internal Circuit	Pulse transformer isolated

SD Memory Card Slot

Points	1
Supported SD Card	SD memory cards (max 2 GB), SDHC memory cards (max 32 GB)
File System	FAT16, FAT32
Function	Downloading/uploading user programs
Insertion/Removal Durability	2,000 times

Cartridge Slots

Type No.	FC6A-C16R1AE	FC6A-C24R1AE FC6A-C24R4AE FC6A-C24R1CE FC6A-C24R4CE FC6A-C24K1CE FC6A-C24R1CE FC6A-C24R4CE FC6A-C24K1CE FC6A-C24K4CE FC6A-C24P1CE FC6A-C24P4CE	FC6A-C40R1AE	FC6A-C40R1AEJ	
	FC6A-C16R4AE		FC6A-C40R4AE	FC6A-C40R4AEJ	
	FC6A-C16R1CE		FC6A-C40R1CE	FC6A-C40R1CEJ	
	FC6A-C16R4CE		FC6A-C40R4CE	FC6A-C40R4CEJ	
	FC6A-C16K1CE		FC6A-C40K1CE	FC6A-C40K1CEJ	
	FC6A-C16K4CE		FC6A-C40K4CE	FC6A-C40K4CEJ	
	FC6A-C16P1CE		FC6A-C40P1CE	FC6A-C40P1CEJ	
	FC6A-C16P4CE		FC6A-C40P4CE	FC6A-C40P4CEJ	
	FC6A-C16R1DE		FC6A-C40R1DE	FC6A-C40R1DEJ	
	FC6A-C16R4DE		FC6A-C40R4DE	FC6A-C40R4DEJ	
	FC6A-C16K1DE		FC6A-C40K1DE	FC6A-C40K1DEJ	
	FC6A-C16K4DE		FC6A-C40K4DE	FC6A-C40K4DEJ	
	FC6A-C16P1DE		FC6A-C40P1DE	FC6A-C40P1DEJ	
	FC6A-C16P4DE		FC6A-C40P4DE	FC6A-C40P4DEJ	
Cartridge Connections*1	Slots	1	1	2	2

When the HMI module is connected, the analog I/O cartridge or the digital I/O cartridge can be expanded.

*1 All devices that are connectable to the cartridge slots cannot be used in expanded ambient operating temperatures (-25 to -10°C and 55 to 65°C). Do not connect these devices when the product is used in expanded ambient operating temperatures.

Communication Connector

HMI Module Connection*1	Slots	1
--------------------------------	--------------	---

*1 All devices that are connectable to the communication connector cannot be used in expanded ambient operating temperatures (-25 to -10°C and 55 to 65°C). Do not connect these devices when the product is used in expanded ambient operating temperatures.

2: PRODUCT SPECIFICATIONS

■ All-in-One CPU Module Only

Analog Potentiometer

Points	1
Data Resolution	0 to 1,000

Analog Input

Points	1
Input Range	0 to 10 V
Data Resolution	0 to 1,000
Input Impedance	Approx. 100 k Ω
Error	$\pm 1\%$ of full scale ($\pm 5\%$ of full scale when noise is applied)
Input Delay Time	12 ms (including the software filter)
Maximum Allowed Steady Load	13 V
Isolation	Not isolated
Cable	Unshielded cable 1 m (included with the product)

Serial Port 1

Points	1 (ports can be added that are capable of using RS-232C or RS-485 communication by using cartridges.)
Communication Type	EIA RS-232C or RS-485 software selectable
Maximum Communication Speed	115,200 bps
Communication Functions	Maintenance communication, user communication, Modbus communication, data link communication
Connector	RJ45
Cable	RS232C: Shielded multicore RS485: Shielded twisted-pair
Maximum Cable Length	RS-232C: 5 m RS-485 : 200 m
Isolation between Internal Circuit	Not isolated

■ CAN J1939 All-in-One CPU Module Only

CAN Port

Points	1
Communication Type	CAN bus communication
Communication Speed	250 kbps
Communication Functions	J1939 communication
Connector	Push-in type : FC6A-PMSE05PN02 Screw fastened type : FC6A-PMTE05PN02
Cable	SAE-J1939-11 : Shielded twisted-pair SAE-J1939-15 : Unshielded twisted-pair
Maximum Cable Length	SAE-J1939-11 : 40 m, stub 1 m maximum SAE-J1939-15 : 40 m, stub 3 m maximum
Terminating Resistance	120 Ω (0.5 W or higher)
Isolation between Internal Circuit	Power supply: Transformer isolated Signal: Galvanic isolation, photocoupler isolated

DC Input Specifications

■ AC Power Type, 24V DC Power Type

Type No.		FC6A-C16R1AE FC6A-C16R4AE FC6A-C16R1CE FC6A-C16R4CE FC6A-C16K1CE FC6A-C16K4CE FC6A-C16P1CE FC6A-C16P4CE	FC6A-C24R1AE FC6A-C24R4AE FC6A-C24R1CE FC6A-C24R4CE FC6A-C24K1CE FC6A-C24K4CE FC6A-C24P1CE FC6A-C24P4CE	FC6A-C40R1AE FC6A-C40R4AE FC6A-C40R1CE FC6A-C40R4CE FC6A-C40K1CE FC6A-C40K4CE FC6A-C40P1CE FC6A-C40P4CE FC6A-C40R1AEJ FC6A-C40R4AEJ FC6A-C40R1CEJ FC6A-C40R4CEJ FC6A-C40K1CEJ FC6A-C40K4CEJ FC6A-C40P1CEJ FC6A-C40P4CEJ
Rated Input Voltage		24V DC shared sink/source		
Input Voltage Range		0.0 to 28.8V DC		
Rated Input Current	I0, I1, I6, I7	5 mA/point (at 24V DC)		
	I2 to I5, I10 to I27	7 mA/point (at 24V DC)		
Terminal Arrangement		See "AC Power Type" on page 2-34, "24V DC Power Type" on page 2-37		
Input Impedance	I0, I1, I6, I7	4.9 kΩ		
	I2 to I5, I10 to I27	3.4 kΩ		
Input Delay Time	Turn ON Time	I0, I1, I6, I7	5 μs + software filter setting	
		I2 to I5	35 μs + software filter setting	
		I10 to I27	35 μs + software filter setting	
	Turn OFF Time	I0, I1, I6, I7	5 μs + software filter setting	
		I2 to I5	35 μs + software filter setting	
		I10 to I27	100 μs + software filter setting	
Input Points		9 points in 1 common line	14 points in 1 common line	24 points in 1 common line
Isolation	Between Input Terminals	Not isolated		
	Internal Circuit	Photocoupler isolated		
Input Type		Type 1 (IEC61131-2)		
External Load for I/O Interconnection		Not needed		
Signal Determination Method		Static		
Effect of Improper Input Connection		Even if wiring for sink or source connection is incorrect, no damages are caused. However, if high voltage is applied that exceeds the input voltage range, there is a risk of permanent damage.		
Cable Length		3 m		
I/O Terminal Connector	Type	See "AC Power Type" on page 2-34, "24V DC Power Type" on page 2-37		
	Insertion/Removal Durability	100 times minimum		

2: PRODUCT SPECIFICATIONS

Operating Ranges

The operating range of Type 1 (IEC 61131-2) DC input modules is as follows.

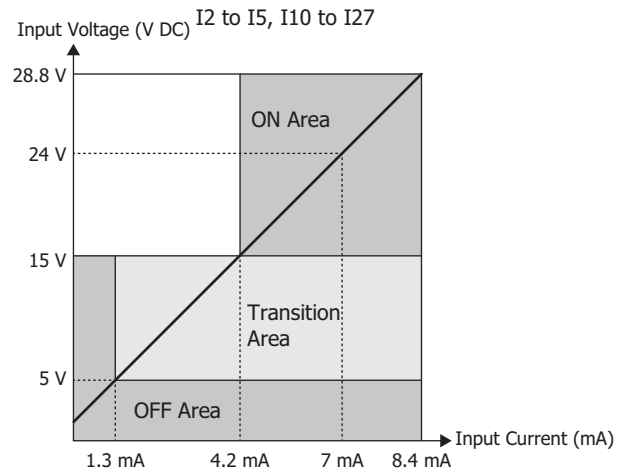
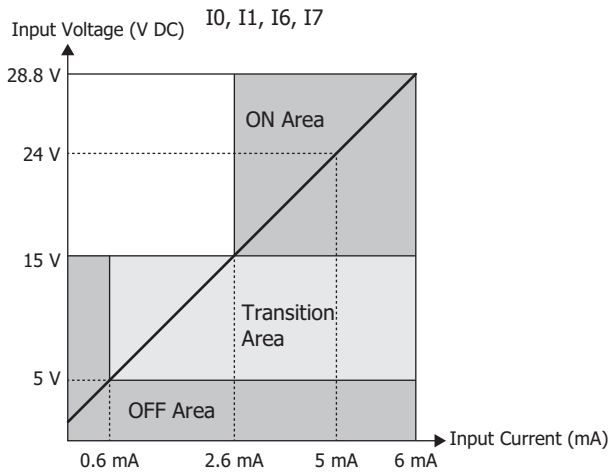

Input Internal Circuit

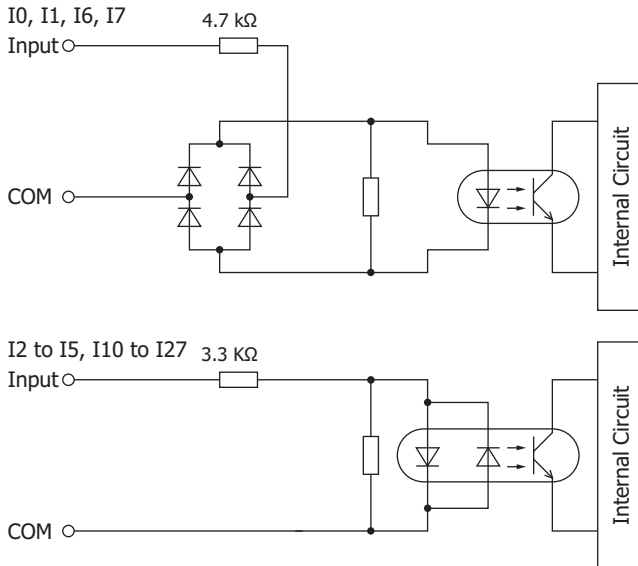

■ 12V DC Power Type

Type No.		FC6A-C16R1DE FC6A-C16R4DE FC6A-C16K1DE FC6A-C16K4DE FC6A-C16P1DE FC6A-C16P4DE	FC6A-C40R1DE FC6A-C40R4DE FC6A-C40K1DE FC6A-C40K4DE FC6A-C40P1DE FC6A-C40P4DE	FC6A-C40R1DEJ FC6A-C40R4DEJ FC6A-C40K1DEJ FC6A-C40K4DEJ FC6A-C40P1DEJ FC6A-C40P4DEJ
Rated Input Voltage	12V DC shared sink/source			
Input Voltage Range	0.0 to 18.0V DC			
Rated Input Current	I0, I1, I6, I7	5 mA/point (at 12V DC)		
	I2 to I5, I10 to I27	6 mA/point (at 12V DC)		
Terminal Arrangement	See "12V DC Power Type" on page 2-43			
Input Impedance	I0, I1, I6, I7	2.0 kΩ		
	I2 to I5, I10 to I27	2.0 kΩ		
Input Delay Time	Turn ON Time	I0, I1, I6, I7	5 μs + software filter setting	
		I2 to I5	35 μs + software filter setting	
		I10 to I27	35 μs + software filter setting	
	Turn OFF Time	I0, I1, I6, I7	5 μs + software filter setting	
		I2 to I5	35 μs + software filter setting	
		I10 to I27	100 μs + software filter setting	
Input Points	9 points in 1 common line	24 points in 1 common line		
Isolation	Between Input Terminals	Not isolated		
	Internal circuit	Photocoupler isolated		
Input Type	Type 1 (IEC61131-2)			
External Load for I/O Interconnection	Not needed			
Signal Determination Method	Static			
Effect of Improper Input Connection	Even if wiring for sink or source connection is incorrect, no damages are caused. However, if high voltage is applied that exceeds the input voltage range, there is a risk of permanent damage.			
Cable Length	3 m			
I/O Terminal Connector	Type	See "12V DC Power Type" on page 2-43		
	Insertion/Removal Durability	100 times minimum		

2: PRODUCT SPECIFICATIONS

Operating Ranges

The operating range of Type 1 (IEC 61131-2) DC input modules is as follows.

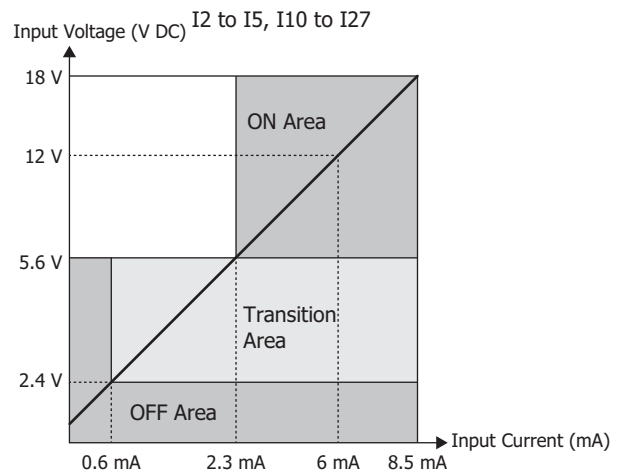
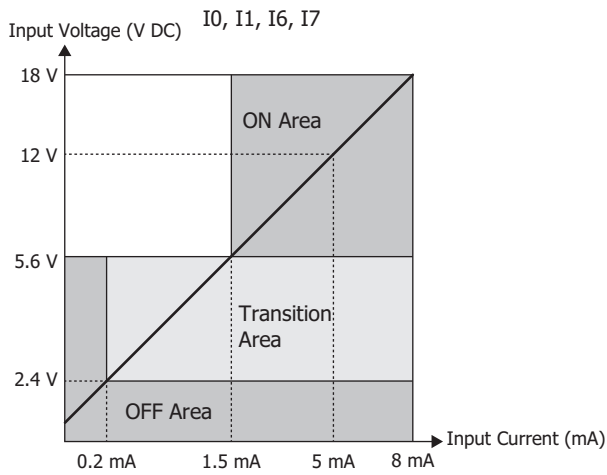

Input Internal Circuit

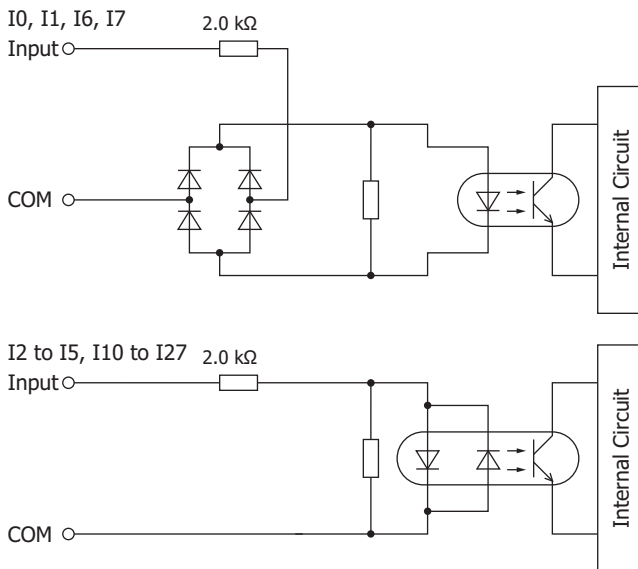

Relay Output Specifications

■ AC Power Type, 24V DC Power Type, 12V DC Power Type

Type No.		FC6A-C16R1AE FC6A-C16R4AE FC6A-C16R1CE FC6A-C16R4CE FC6A-C16R1DE FC6A-C16R4DE	FC6A-C24R1AE FC6A-C24R4AE FC6A-C24R1CE FC6A-C24R4CE	FC6A-C40R1AE FC6A-C40R4AE FC6A-C40R1CE FC6A-C40R4CE FC6A-C40R1DE FC6A-C40R4DE FC6A-C40R1AEJ FC6A-C40R4AEJ FC6A-C40R1CEJ FC6A-C40R4CEJ FC6A-C40R1DEJ FC6A-C40R4DEJ
No. of Outputs		7	10	16
Output Points per Common Line	COM0	4	4	4
	COM1	3	4	4
	COM2	—	2	4
	COM3	—	—	4
Terminal Arrangement		See "AC Power Type" on page 2-34, "24V DC Power Type" on page 2-37, "12V DC Power Type" on page 2-43		
Output Type		1a contact		
Maximum Load Current *1	1	2 A maximum		
	1 Common	7 A maximum		
Minimum Switching Load		1.0 mA/5.0V DC (reference value)		
Initial Contact Resistance		30 mΩ or lower		
Electrical Life		100,000 operations minimum (rated load 1,800 operations/hour)		
Mechanical Life		20,000,000 operations minimum (no load 18,000 operations/hour)		
Rated Load *1		240V AC 2 A, 30V DC 2 A		
Withstand Voltage	Between Output Terminal and FE	2,300V AC 1 minute		
	Between Output Terminal and Internal Circuit	2,300V AC 1 minute		
	Between Output Terminals (COMs)	2,300V AC 1 minute		
I/O Terminal Connector	Type	See "AC Power Type" on page 2-34, "24V DC Power Type" on page 2-37, "12V DC Power Type" on page 2-43		
	Insertion/Removal Durability	100 times minimum		

*1 Values for resistive/inductive load.

Output Delay

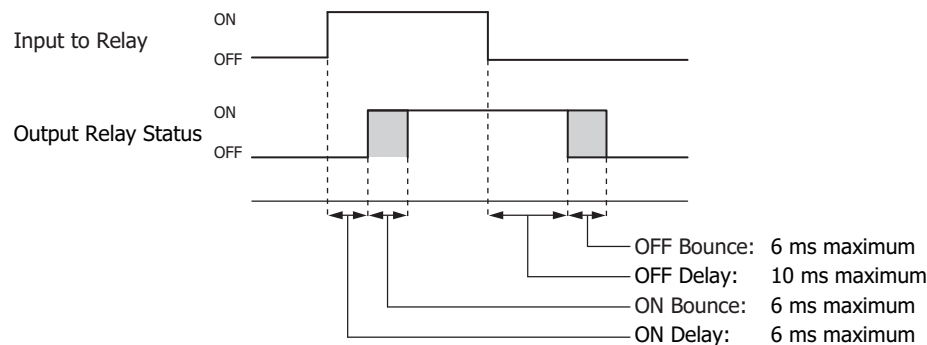

2: PRODUCT SPECIFICATIONS

Transistor Sink Output Specifications

■ 24V DC power type

Type No.		FC6A-C16K1CE FC6A-C16K4CE	FC6A-C24K1CE FC6A-C24K4CE	FC6A-C40K1CE FC6A-C40K4CE	FC6A-C40K1CEJ FC6A-C40K4CEJ
No. of Outputs		7	10	16	
Output Points per Common Line	COM0	7	10	8	
	COM1	—	—	8	
Rated Load Voltage		24V DC			
Operating Load Voltage Range		20.4 to 28.8V DC			
Terminal Arrangement		See "24V DC Power Type" on page 2-37			
Maximum Load Current	1	0.5 A maximum			
	1 Common	3.5 A maximum	5 A maximum	4 A maximum	
Voltage Drop (ON Voltage)		1 V or less, voltage between COM and output terminal when ON			
Maximum Inrush Current		1 A			
Leakage Current		0.1 mA maximum			
Clamping Voltage		39 V±1 V			
Maximum Lamp Load		12 W			
Inductive Load		L/R = 10 ms (28.8V DC, 1 Hz)			
External Current Draw		100 mA maximum, 24V DC (+V terminal supply power)			
Isolation	Between Output Terminal and Internal Circuit	Photocoupler isolated			
	Between Output Terminals	Not isolated			
I/O Terminal Connector	Type	See "24V DC Power Type" on page 2-37			
	Insertion/Removal Durability	100 times minimum			
Output Delay	Turn ON Time	Q0 to Q1: 5 μs or less Q2 to Q3: 30 μs or less Q4 to Q7, Q10 to Q17: 300 μs or less			Q0 to Q7: 5 μs or less Q10 to Q17: 300 μs or less
	Turn OFF Time	Q0 to Q1: 5 μs or less Q2 to Q3: 30 μs or less Q4 to Q7, Q10 to Q17: 300 μs or less			Q0 to Q7: 5 μs or less Q10 to Q17: 300 μs or less

Output Internal Circuit

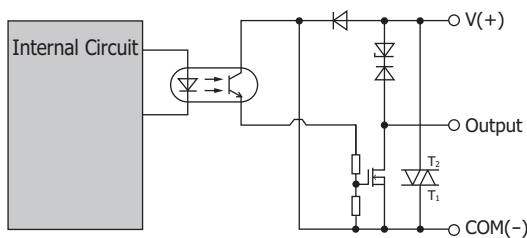

■ 12V DC Power Type

Type No.		FC6A-C16K1DE FC6A-C16K4DE	FC6A-C40K1DE FC6A-C40K4DE	FC6A-C40K1DEJ FC6A-C40K4DEJ
No. of Outputs		7	16	
Output Points per Common Line	COM0	7	8	
	COM1	—	8	
Rated Load Voltage		12V DC		
Operating Load Voltage Range		10.2 to 18.0V DC	10.2 to 16.0V DC	
Terminal Arrangement		See "12V DC Power Type" on page 2-43		
Maximum Load Current	1	0.5 A maximum		
	1 Common	3.5 A maximum	4 A maximum	
Voltage Drop (ON Voltage)		1 V or less, voltage between COM and output terminal when ON		
Maximum Inrush Current		1 A		
Leakage Current		0.1 mA maximum		
Clamping Voltage		39 V±1 V	27 V±1 V	
Maximum Lamp Load		12 W		
Inductive Load		L/R = 10 ms (18.0V DC, 1 Hz)	L/R = 10 ms (16.0V DC, 1 Hz)	
External Current Draw		100 mA maximum, 12V DC (+V terminal supply power)		
Isolation	Between Output Terminal and Internal Circuit	Photocoupler isolated		
	Between Output Terminals	Not isolated		
I/O Terminal Connector	Type	See "12V DC Power Type" on page 2-43		
	Insertion/Removal Durability	100 times minimum		
Output Delay	Turn ON Time	Q0 to Q1: 5 μs or less Q2 to Q3: 30 μs or less Q4 to Q7, Q10 to Q17: 300 μs or less	Q0 to Q7: 5 μs or less Q10 to Q17: 300 μs or less	
	Turn OFF Time	Q0 to Q1: 5 μs or less Q2 to Q3: 30 μs or less Q4 to Q7, Q10 to Q17: 300 μs or less	Q0 to Q7: 5 μs or less Q10 to Q17: 300 μs or less	

Output Internal Circuit

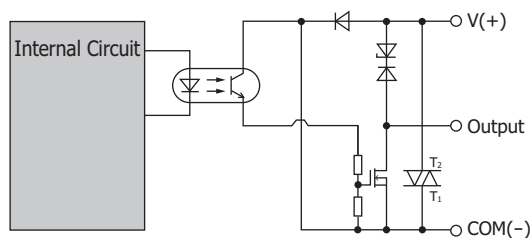

2: PRODUCT SPECIFICATIONS

Transistor Protection Source Output Specifications

■ 24V DC power type

Type No.		FC6A-C16P1CE FC6A-C16P4CE	FC6A-C24P1CE FC6A-C24P4CE	FC6A-C40P1CE FC6A-C40P4CE	FC6A-C40P1CEJ FC6A-C40P4CEJ
No. of Outputs		7	10	16	
Output Points per Common Line	COM0	7	10	8	
	COM1	—	—	8	
Rated Load Voltage		24V DC			
Operating Load Voltage Range		20.4 to 28.8V DC			
Terminal Arrangement		See "24V DC Power Type" on page 2-37			
Maximum Load Current	1	0.5 A maximum			
	1 Common	3.5 A maximum	5 A maximum	4 A maximum	
Voltage Drop (ON Voltage)		1 V or less, voltage between COM and output terminal when ON			
Maximum Inrush Current		1 A			
Leakage Current		0.1 mA maximum			
Clamping Voltage		39 V±1 V			
Maximum Lamp Load		12 W			
Inductive Load		L/R = 10 ms (28.8V DC, 1 Hz)			
External Current Draw		100 mA maximum, 24V DC (-V terminal supply power)			
Output Protection Functions		Overcurrent protection function (not a thermal shutdown function). Overcurrent detected with 4 outputs as 1 group. (Group 1: Q0 to Q3, Group 2: Q4 to Q7, Group 3: Q10 to Q13, Group 4: Q14 to Q17) When overcurrent is detected, the 4 outputs in the corresponding group are turned off for a fixed period (1 s). When overcurrent is detected, a special internal relay turns on (M8172 to M8175) and the error LED [ERR] turns on.			
Output Current Limit Value		1.0 to 2.0 A			
Isolation	Between Output Terminal and Internal Circuit	Photocoupler isolated			
	Between Output Terminals	Not isolated			
I/O Terminal Connector	Type	See "24V DC Power Type" on page 2-37			
	Insertion/Removal Durability	100 times minimum			
Output Delay	Turn ON Time	Q0 to Q1: 5 μs or less Q2 to Q3: 30 μs or less Q4 to Q7, Q10 to Q17: 300 μs or less			Q0 to Q7: 5 μs or less Q10 to Q17: 300 μs or less
	Turn OFF Time	Q0 to Q1: 5 μs or less Q2 to Q3: 30 μs or less Q4 to Q7, Q10 to Q17: 300 μs or less			Q0 to Q7: 5 μs or less Q10 to Q17: 300 μs or less

Output Internal Circuit (The overcurrent detection circuit has been omitted.)

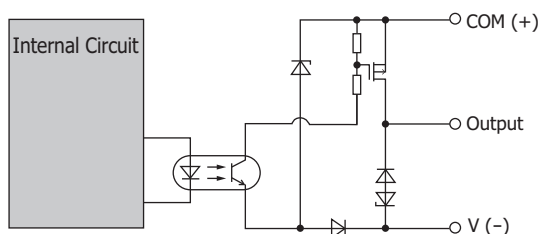

■ 12V DC Power Type

Type No.		FC6A-C16P1DE FC6A-C16P4DE	FC6A-C40P1DE FC6A-C40P4DE	FC6A-C40P1DEJ FC6A-C40P4DEJ
No. of Outputs		7	16	
Output Points per Common Line	COM0	7	8	
	COM1	—	8	
Rated Load Voltage		12V DC		
Operating Load Voltage Range		10.2 to 18.0V DC	10.2 to 16.0V DC	
Terminal Arrangement		See "12V DC Power Type" on page 2-43		
Maximum Load Current	1	0.5 A maximum		
	1 Common	3.5 A maximum	4 A maximum	
Voltage Drop (ON Voltage)		1 V or less, voltage between COM and output terminal when ON		
Maximum Inrush Current		1 A		
Leakage Current		0.1 mA maximum		
Clamping Voltage		39 V±1 V	27 V±1 V	
Maximum Lamp Load		12 W		
Inductive Load		L/R = 10 ms (28.8V DC, 1 Hz)		L/R = 10 ms (16.0V DC 1 Hz)
External Current Draw		100 mA maximum, 12V DC (-V terminal supply power)		
Output Protection Functions		Overcurrent protection function (not a thermal shutdown function). Overcurrent detected with 4 outputs as 1 group. When overcurrent is detected, the 4 corresponding outputs are turned off for a fixed period (1 s). When overcurrent is detected, a special internal relay turns on (M8172) and the error LED [ERR] turns on.		
Output Current Limit Value		1.0 to 2.0 A		
Isolation	Between Output Terminal and Internal Circuit	Photocoupler isolated		
	Between Output Terminals	Not isolated		
I/O Terminal Connector	Type	See "12V DC Power Type" on page 2-43		
	Insertion/Removal Durability	100 times minimum		
Output Delay	Turn ON Time	Q0 to Q1: 5 μs or less Q2 to Q3: 30 μs or less Q4 to Q7, Q10 to Q17: 300 μs or less		Q0 to Q7: 5 μs or less Q10 to Q17: 300 μs or less
	Turn OFF Time	Q0 to Q1: 5 μs or less Q2 to Q3: 30 μs or less Q4 to Q7, Q10 to Q17: 300 μs or less		Q0 to Q7: 5 μs or less Q10 to Q17: 300 μs or less

Output Internal Circuit (The overcurrent detection circuit has been omitted.)

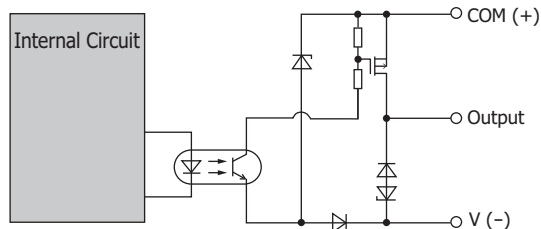

2: PRODUCT SPECIFICATIONS

Ambient Temperature, Input Voltage, Output Voltage, I/O Simultaneous ON Ratio

When the FC6A Series MICROSmart is used in an ambient temperature of 45°C or higher, reduce the input voltage and I/O utilization (simultaneous ON ratio: a%) according to the following diagrams. However, the following diagrams show the temperature conditions when the FC6A Series MICROSmart is normally installed.

Note: Normally installed means the state in the diagram in "Normal Installation State" on page 3-1.

The usage conditions will also change according to the installation state. For details, see "Installation Location" on page 3-1.

■ Relay output type

24V DC Power Type

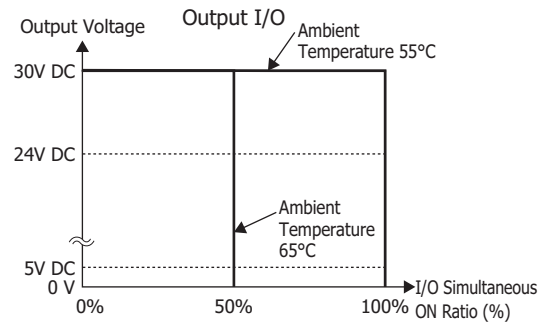
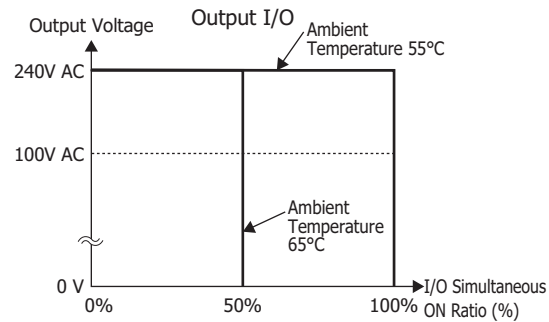
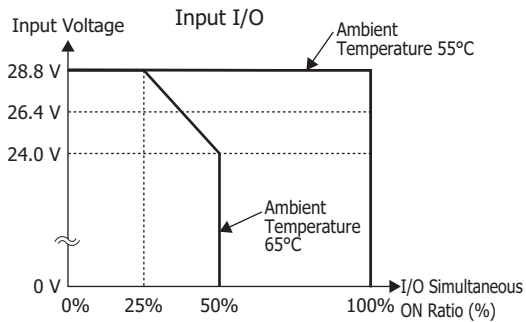

12V DC Power Type

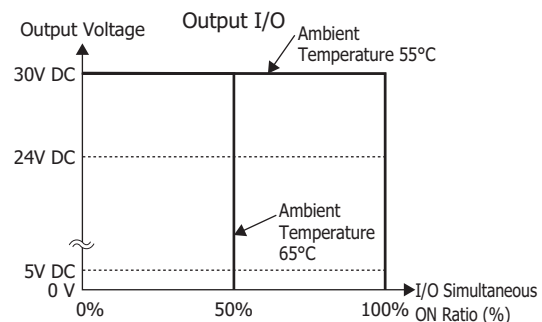
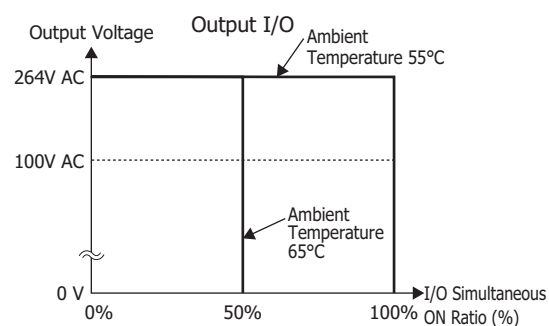
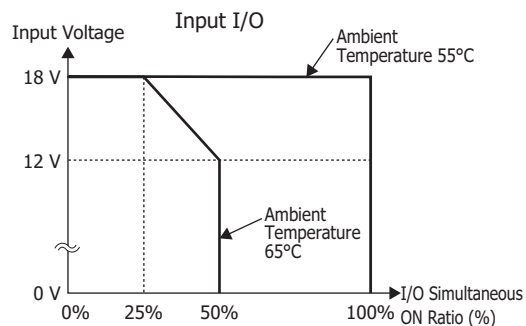

■ Transistor sink output type

- There are no usage restrictions for input and output I/O when the ambient temperature is 55°C or lower and no cartridges are connected.
- When a cartridge is connected or the ambient temperature is greater than 55°C, reduce the input voltage, output voltage, and I/O simultaneous ON ratio as shown in the following diagrams. *1

24V DC Power Type

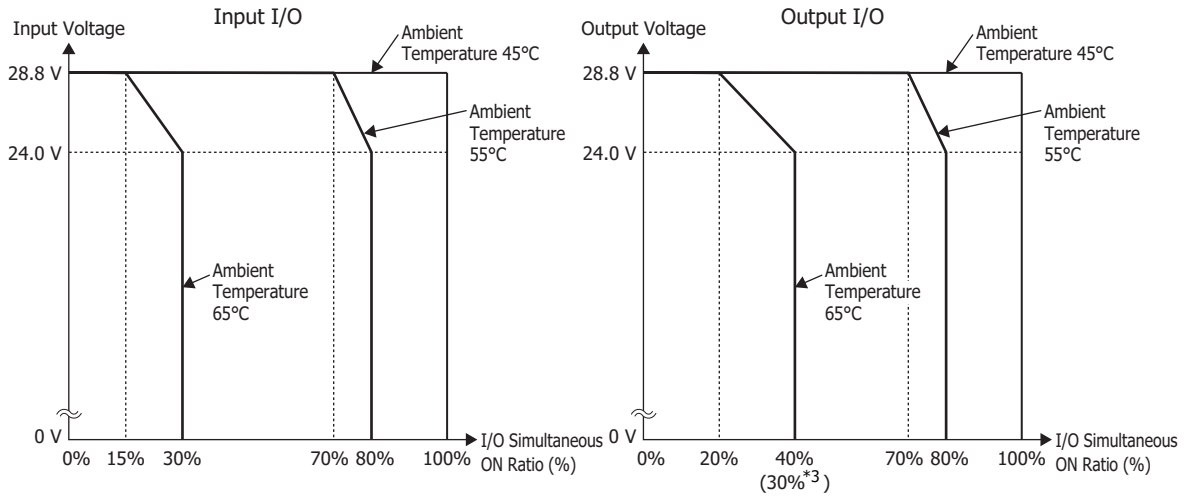

12V DC Power Type

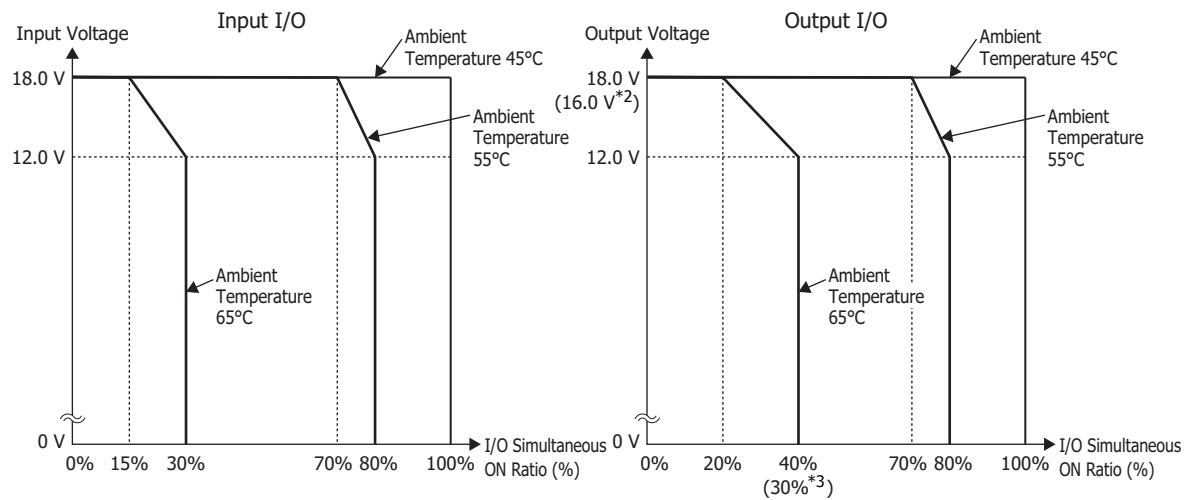

*1 Cartridges cannot be used in environments with expanded ambient operating temperatures (-25 to -10°C and 55 to 65°C).

*2 The values in parentheses are for the CAN J1939 All-in-One CPU module.

*3 The values in parentheses are for the 16-I/O type All-in-One CPU module.

2: PRODUCT SPECIFICATIONS

■ Transistor protection source output type

- When the ambient temperature is 55°C or lower and no cartridges are connected, reduce the input voltage, output voltage, and I/O simultaneous ON ratio as shown in the following diagrams.

24V DC Power Type

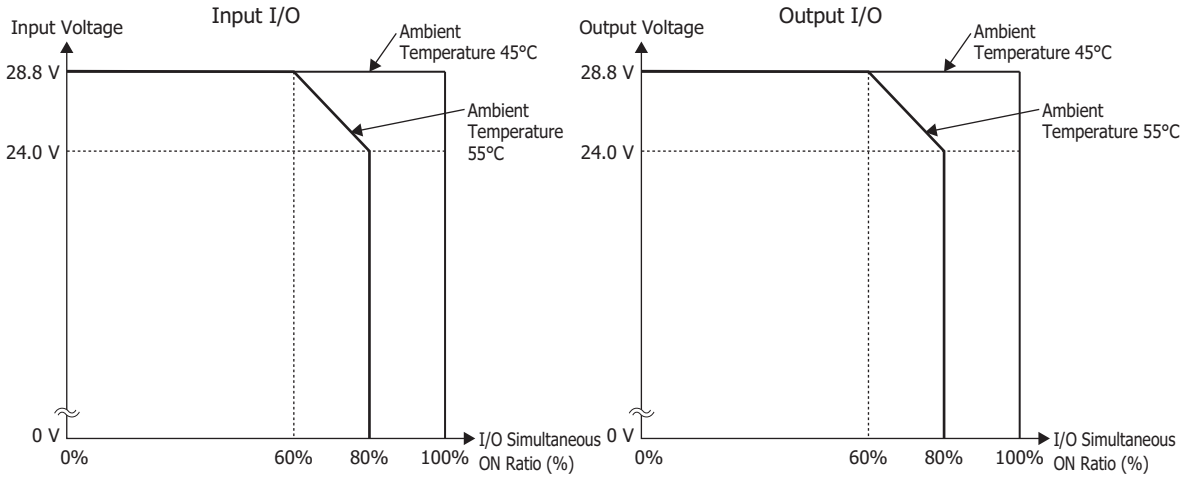

12V DC Power Type

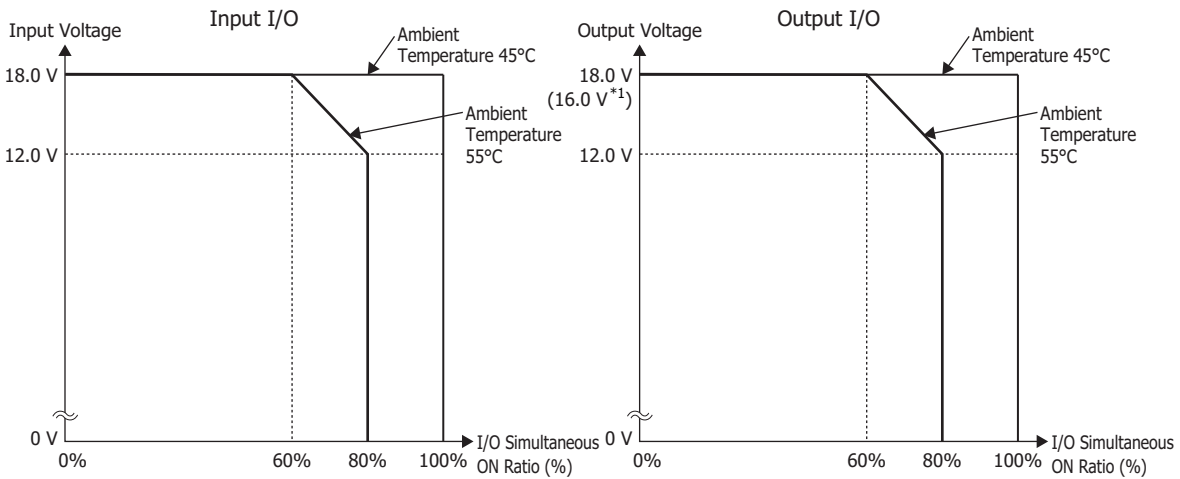

*1 The values in parentheses are for the CAN J1939 All-in-One CPU module.

- When a cartridge is connected or the ambient temperature is greater than 55°C, reduce the input voltage, output voltage, and I/O simultaneous ON ratio as shown in the following diagrams. *1

24V DC Power Type

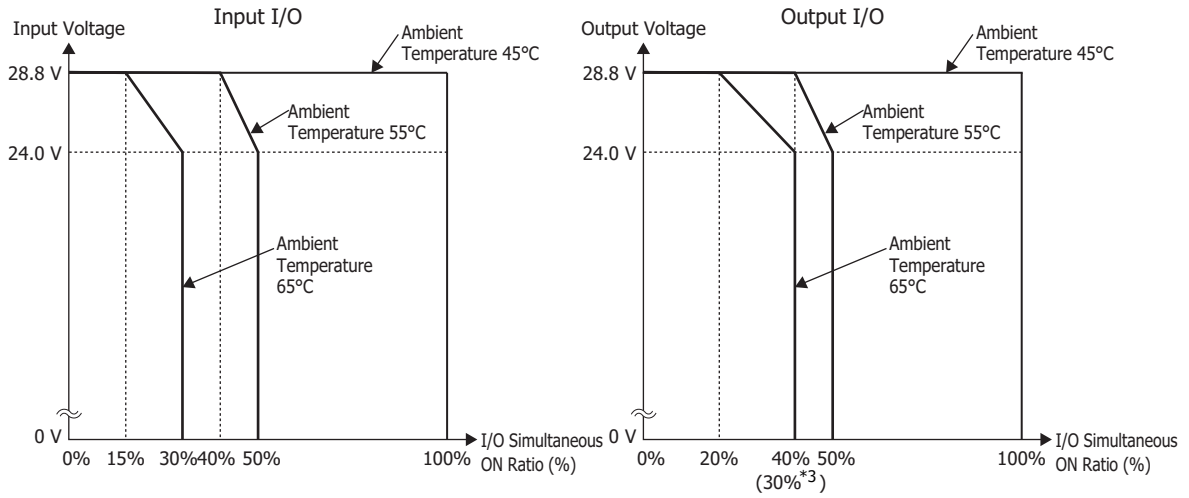

12V DC Power Type

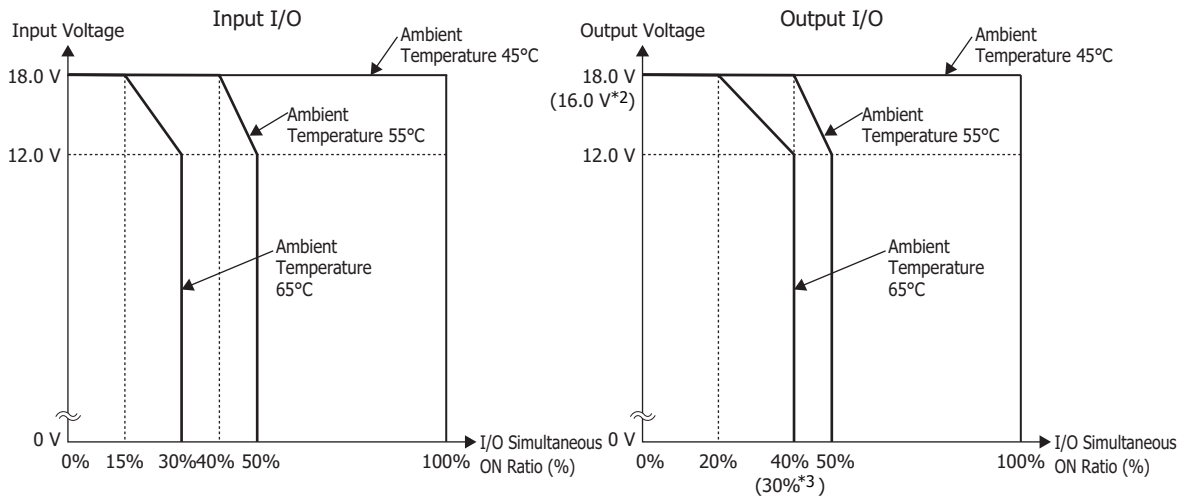

*1 Cartridges cannot be used in environments with expanded ambient operating temperatures (-25 to -10°C and 55 to 65°C).

*2 The values in parentheses are for the CAN J1939 All-in-One CPU module.

*3 The values in parentheses are for the 16-I/O type All-in-One CPU module.

2: PRODUCT SPECIFICATIONS

Terminal Arrangement and Wiring Examples

■ AC Power Type

16-I/O Type: Screw fastened type: FC6A-C16R1AE

Push-in type: FC6A-C16R4AE

Applicable connector

(1) Power supply terminals	Screw fastened type	FC6A-PMTD03PN02
	Push-in type (AC)	FC6A-PMSDA03PN02
(2) Sensor power terminals, input terminals	Screw fastened type	FC6A-PMTA12PN02
	Push-in type	FC6A-PMSA12PN02
(3) Output terminals	Screw fastened type	FC6A-PMTA09PN02
	Push-in type	FC6A-PMSA09PN02

Screw fastened type

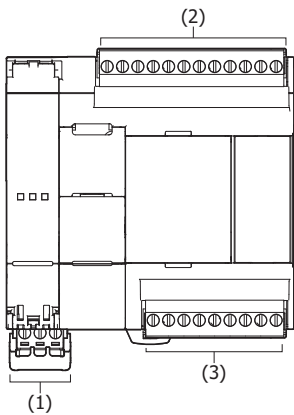

Push-in type

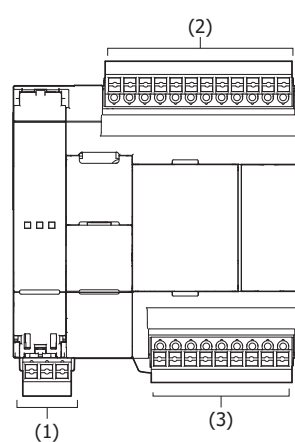

(1) Power supply terminals

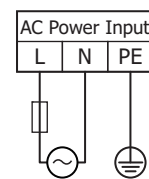

 : Fuse

 : Load

(2) Sensor power terminals, input terminals

DC Sink Input Wiring

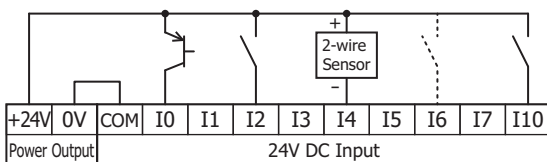

DC Source Input Wiring

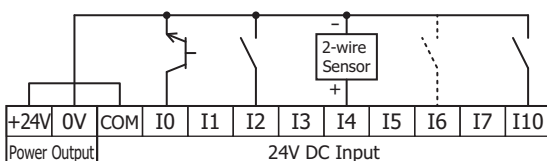

(3) Output terminals

Relay Output

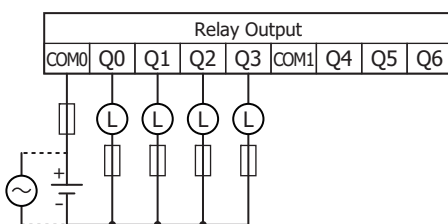

24-I/O Type: Screw fastened type: FC6A-C24R1AE
Push-in type: FC6A-C24R4AE

Applicable connector

(1) Power supply terminals	Screw fastened type	FC6A-PMTD03PN02
	Push-in type (AC)	FC6A-PMSDA03PN02
(2) Sensor power terminals, input terminals	Screw fastened type	FC6A-PMTA08PN02
		FC6A-PMTA09PN02
	Push-in type	FC6A-PMSA08PN02
		FC6A-PMSA09PN02
(3) Output terminals	Screw fastened type	FC6A-PMTA13PN02
	Push-in type	FC6A-PMSA13PN02

Screw fastened type

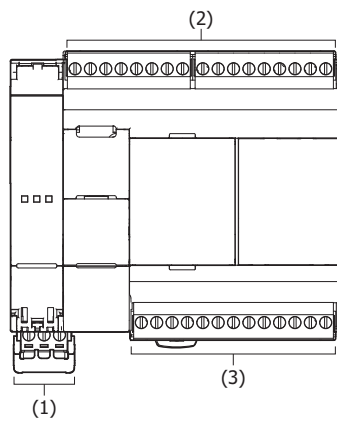

Push-in type

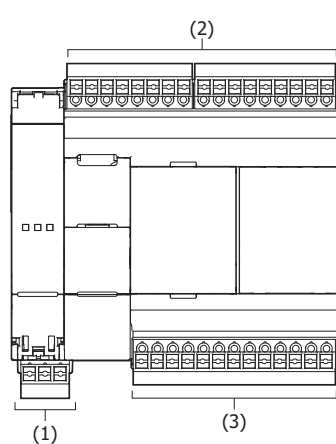

(1) Power supply terminals

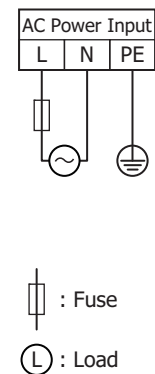

(2) Sensor power terminals, input terminals

DC Sink Input Wiring

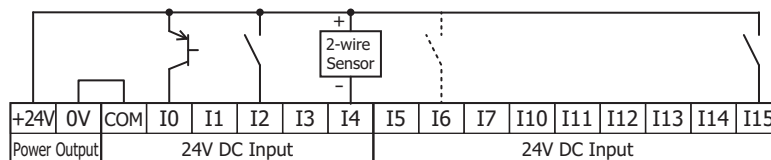

DC Source Input Wiring

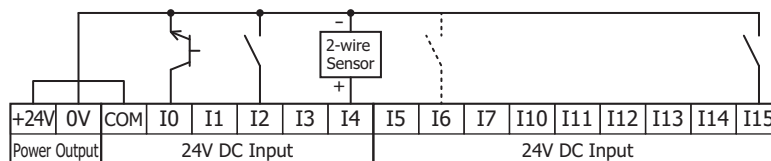

(3) Output terminals

Relay Output

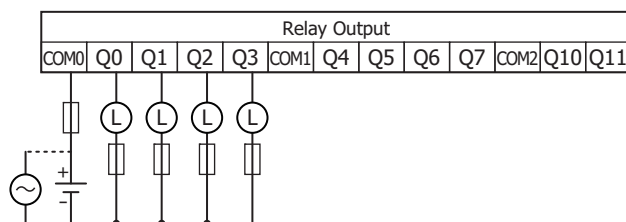

2: PRODUCT SPECIFICATIONS

40-I/O Type: Screw fastened type: FC6A-C40R1AE, FC6A-C40R1AEJ

Push-in type: FC6A-C40R4AE, FC6A-C40R4AEJ

Applicable connector

(1) Power supply terminals	Screw fastened type	FC6A-PMTD03PN02
	Push-in type (AC)	FC6A-PMSDA03PN02
(2) Sensor power terminals, input terminals	Screw fastened type	FC6A-PMTA09PN02
	Push-in type	FC6A-PMSA09PN02
(3) Output terminals	Screw fastened type	FC6A-PMTA10PN02
	Push-in type	FC6A-PMSA10PN02

Screw fastened type

Push-in type

(1) Power supply terminals

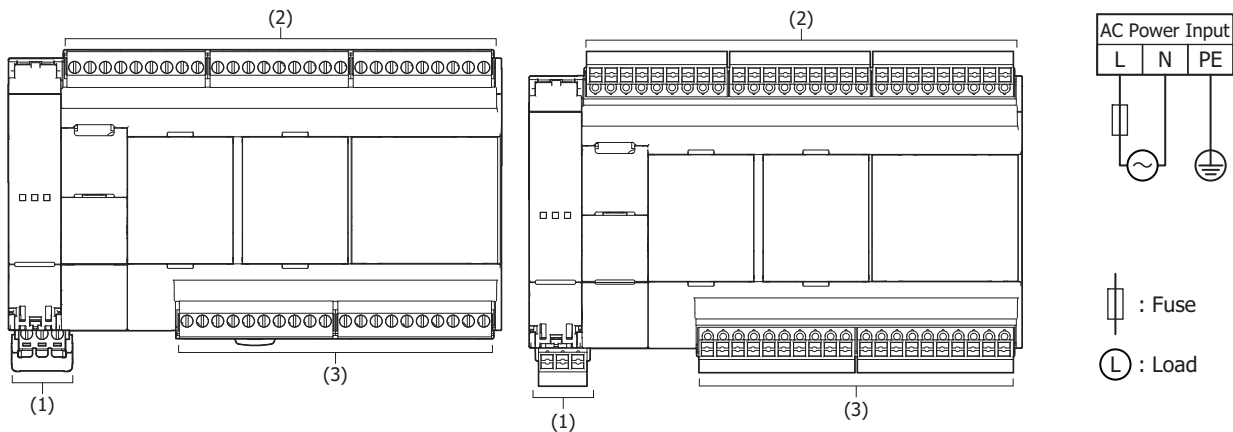

(2) Sensor power terminals, input terminals

DC Sink Input Wiring

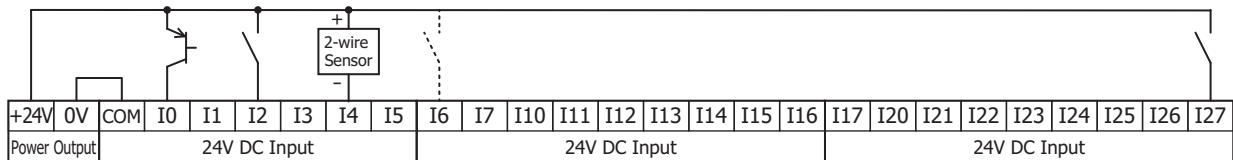

DC Source Input Wiring

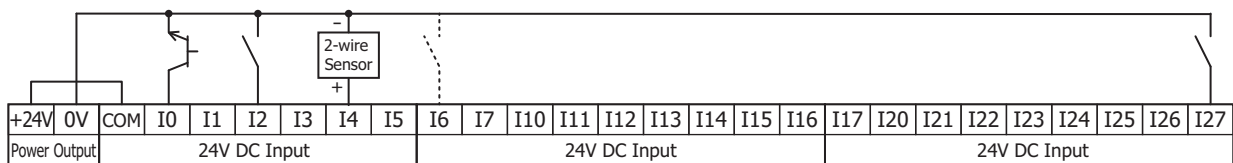

(3) Output terminals

Relay Output

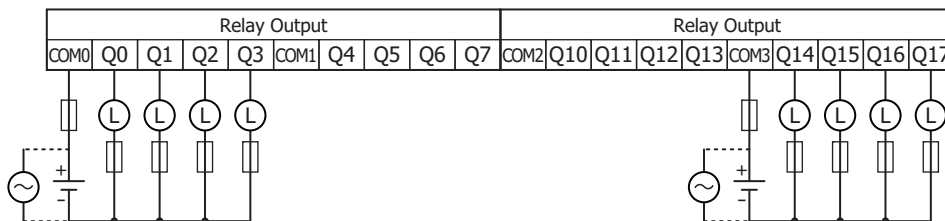

■ 24V DC Power Type

16-I/O type: Screw fastened type: FC6A-C16R1CE, FC6A-C16K1CE, FC6A-C16P1CE
 Push-in type: FC6A-C16R4CE, FC6A-C16K4CE, FC6A-C16P4CE

Applicable connector

(1) Power supply terminals	Screw fastened type	FC6A-PMTD03PN02
	Push-in type (24 VDC)	FC6A-PMSDC03PN02
(2) Sensor power terminals, input terminals	Screw fastened type	FC6A-PMTA12PN02
	Push-in type	FC6A-PMSA12PN02
(3) Output terminals	Screw fastened type	FC6A-PMTA09PN02
	Push-in type	FC6A-PMSA09PN02

Screw fastened type

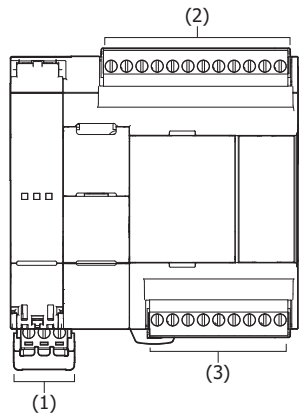

Push-in type

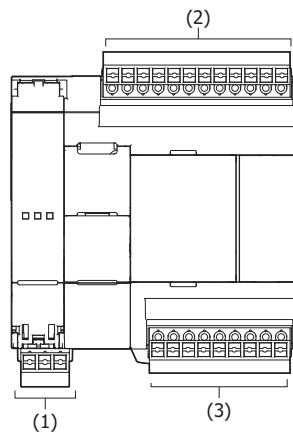

(1) Power supply terminals

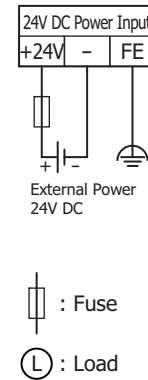

(2) Input terminals

DC Sink Input Wiring

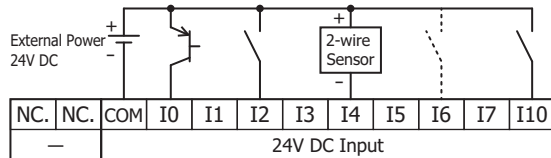

DC Source Input Wiring

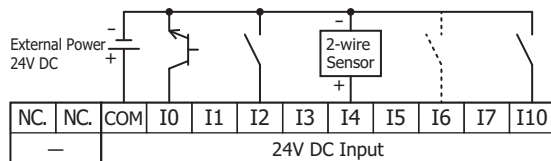

2: PRODUCT SPECIFICATIONS

(3) Output terminals

Relay Output: FC6A-C16R1CE, FC6A-C16R4CE

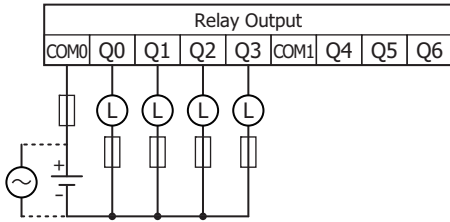

Transistor Sink Output: FC6A-C16K1CE, FC6A-C16K4CE

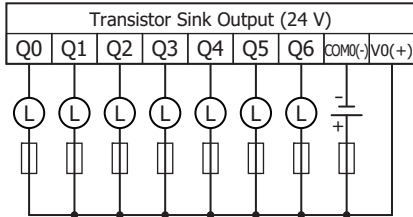

Transistor Protection Source Output: FC6A-C16P1CE, FC6A-C16P4CE

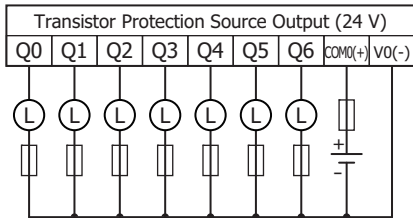

24-I/O Type: Screw fastened type: FC6A-C24R1CE, FC6A-C24K1CE, FC6A-C24P1CE
Push-in type: FC6A-C24R4CE, FC6A-C24K4CE, FC6A-C24P4CE

Applicable connector

(1) Power supply terminals	Screw fastened type	FC6A-PMTD03PN02
	Push-in type (24 VDC)	FC6A-PMSDC03PN02
(2) Sensor power terminals, input terminals	Screw fastened type	FC6A-PMTA08PN02
		FC6A-PMTA09PN02
	Push-in type	FC6A-PMSA08PN02
		FC6A-PMSA09PN02
(3) Output terminals	Screw fastened type	FC6A-PMTA13PN02
	Push-in type	FC6A-PMSA13PN02

Screw fastened type

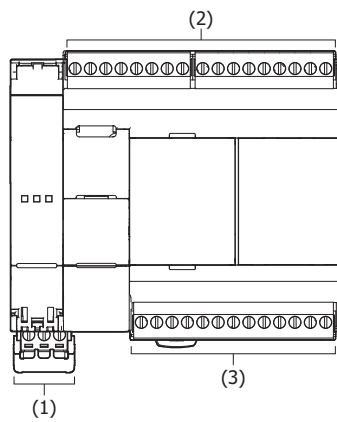

Push-in type

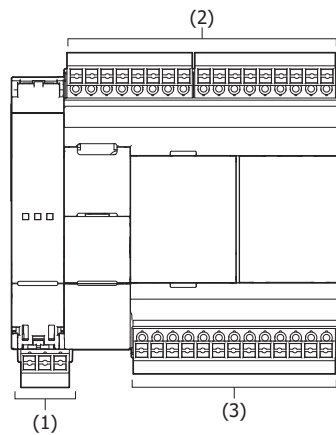

(1) Power supply terminals

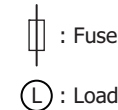
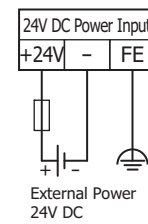

(2) Input terminals

DC Sink Input Wiring

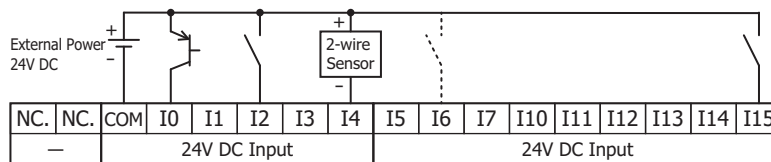

DC Source Input Wiring

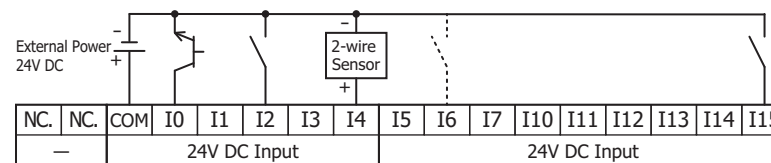

2: PRODUCT SPECIFICATIONS

(3) Output terminals

Relay Output: FC6A-C24R1CE, FC6A-C24R4CE

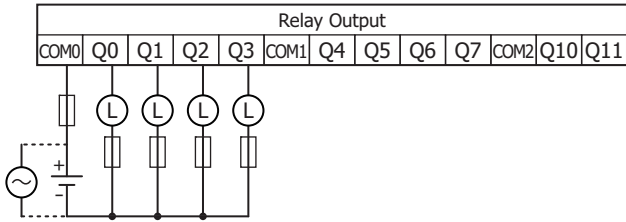

Transistor Sink Output: FC6A-C24K1CE, FC6A-C24K4CE

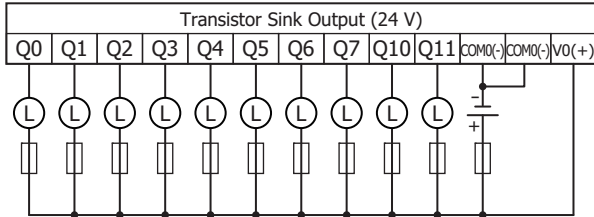

Transistor Protection Source Output: FC6A-C24P1CE, FC6A-C24P4CE

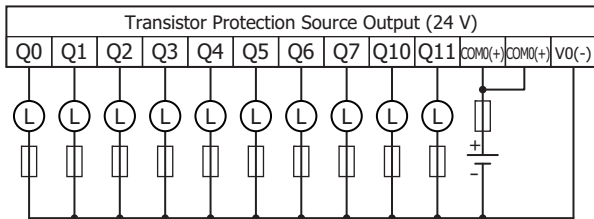

40-I/O Type: Screw fastened type: FC6A-C40R1CE, FC6A-C40K1CE, FC6A-C40P1CE, FC6A-C40R1CEJ, FC6A-C40K1CEJ, FC6A-C40P1CEJ
Push-in type: FC6A-C40R4CE, FC6A-C40K4CE, FC6A-C40P4CE, FC6A-C40R4CEJ, FC6A-C40K4CEJ, FC6A-C40P4CEJ

Applicable connector

(1) Power supply terminals	Screw fastened type	FC6A-PMTD03PN02
	Push-in type (24 VDC)	FC6A-PMSDC03PN02
(2) Sensor power terminals, input terminals	Screw fastened type	FC6A-PMTA09PN02
	Push-in type	FC6A-PMSA09PN02
(3) Output terminals	Screw fastened type	FC6A-PMTA10PN02
	Push-in type	FC6A-PMSA10PN02

Screw fastened type

Push-in type

(1) Power supply terminals

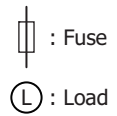
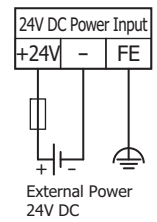
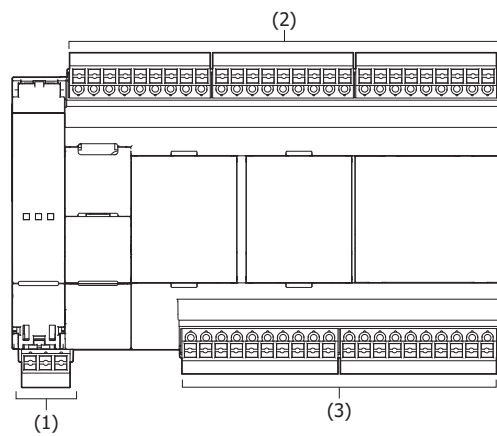
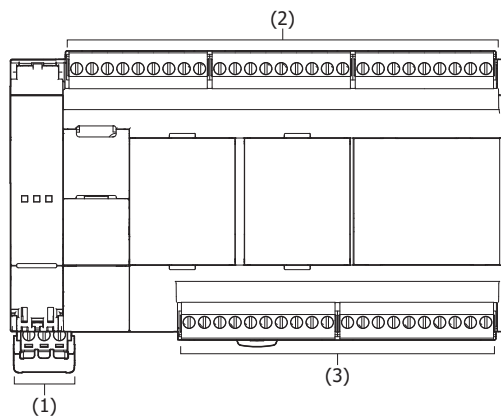

(2) Input terminals

DC Sink Input Wiring

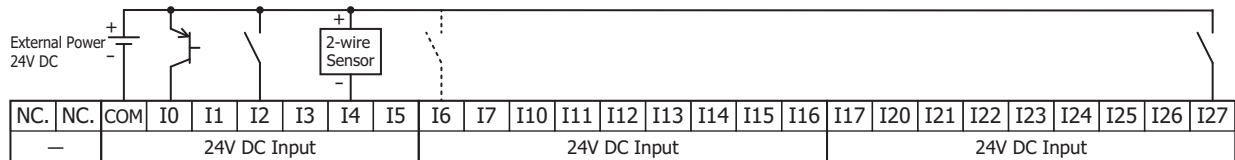

DC Source Input Wiring

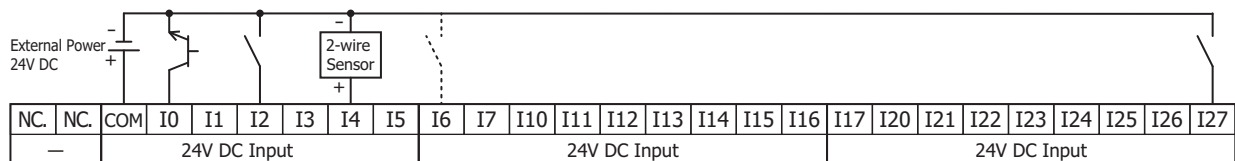

2: PRODUCT SPECIFICATIONS

(3) Output terminals

Relay Output: FC6A-C40R1CE, FC6A-C40R4CE, FC6A-C40R1CEJ, FC6A-C40R4CEJ

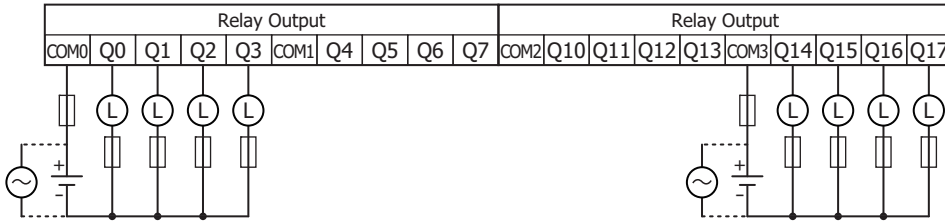

Transistor Sink Output: FC6A-C40K1CE, FC6A-C40K4CE, FC6A-C40K1CEJ, FC6A-C40K4CEJ

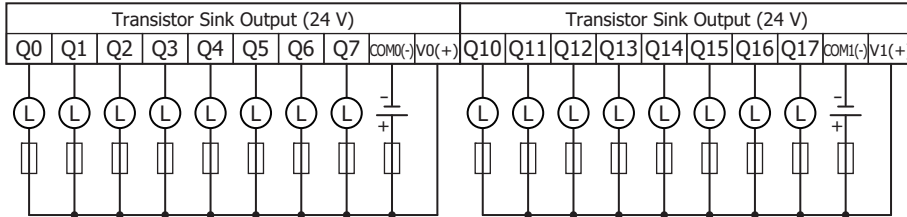

Transistor Protection Source Output: FC6A-C40P1CE, FC6A-C40P4CE, FC6A-C40P1CEJ, FC6A-C40P4CEJ

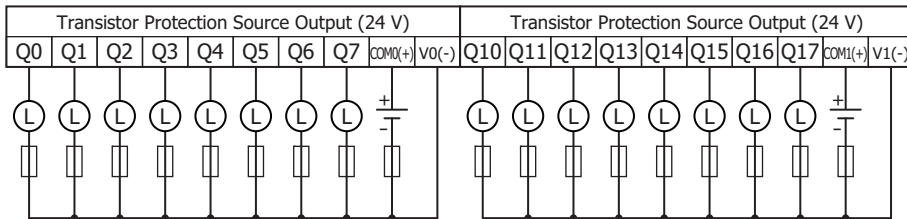

■ 12V DC Power Type

16-I/O type: **Screw fastened type: FC6A-C16R1DE, FC6A-C16K1DE, FC6A-C16P1DE**
Push-in type: FC6A-C16R4DE, FC6A-C16K4DE, FC6A-C16P4DE

Applicable connector

(1) Power supply terminals	Screw fastened type	FC6A-PMTD03PN02
	Push-in type (12 VDC)	FC6A-PMSDD03PN02
(2) Sensor power terminals, input terminals	Screw fastened type	FC6A-PMTA12PN02
	Push-in type	FC6A-PMSA12PN02
(3) Output terminals	Screw fastened type	FC6A-PMTA09PN02
	Push-in type	FC6A-PMSA09PN02

Screw fastened type

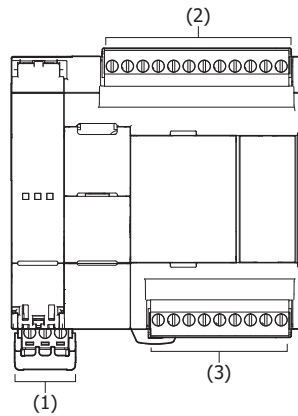

Push-in type

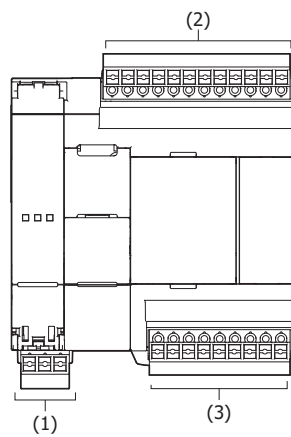

(1) Power supply terminals

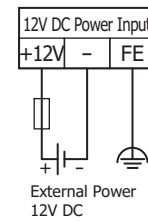

(2) Input terminals

DC Sink Input

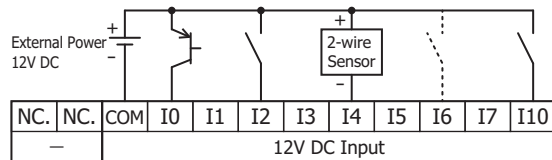

DC Source Input

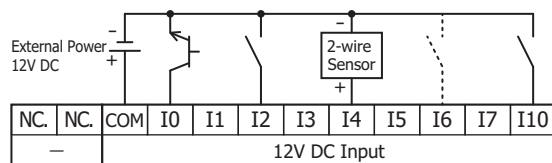

2: PRODUCT SPECIFICATIONS

(3) Output terminals

Relay Output: FC6A-C16R1DE, FC6A-C16R4DE

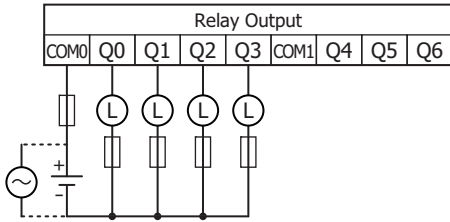

Transistor Sink Output: FC6A-C16K1DE, FC6A-C16K4DE

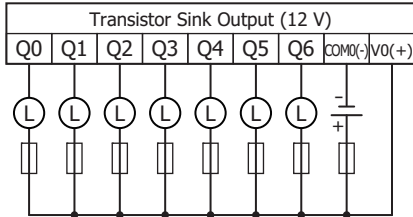

Transistor Protection Source Output: FC6A-C16P1DE, FC6A-C16P4DE

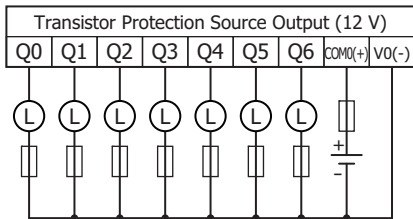

40-I/O Type: Screw fastened type: FC6A-C40R1DE, FC6A-C40K1DE, FC6A-C40P1DE, FC6A-C40R1DEJ, FC6A-C40K1DEJ, FC6A-C40P1DEJ
Push-in type: FC6A-C40R4DE, FC6A-C40K4DE, FC6A-C40P4DE, FC6A-C40R4DEJ, FC6A-C40K4DEJ, FC6A-C40P4DEJ

Applicable connector

(1) Power supply terminals	Screw fastened type	FC6A-PMTD03PN02
	Push-in type (12 VDC)	FC6A-PMSDD03PN02
(2) Sensor power terminals, input terminals	Screw fastened type	FC6A-PMTA09PN02
	Push-in type	FC6A-PMSA09PN02
(3) Output terminals	Screw fastened type	FC6A-PMTA10PN02
	Push-in type	FC6A-PMSA10PN02

Screw fastened type

Push-in type

(1) Power supply terminals

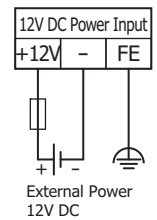
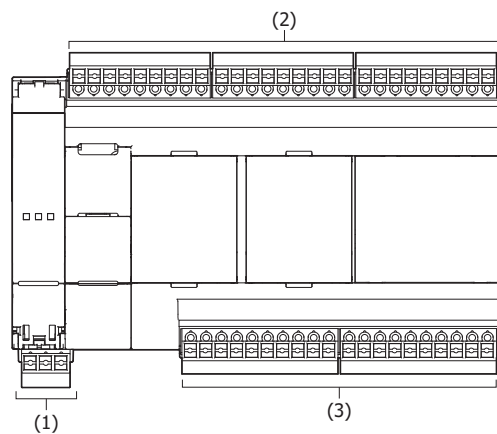
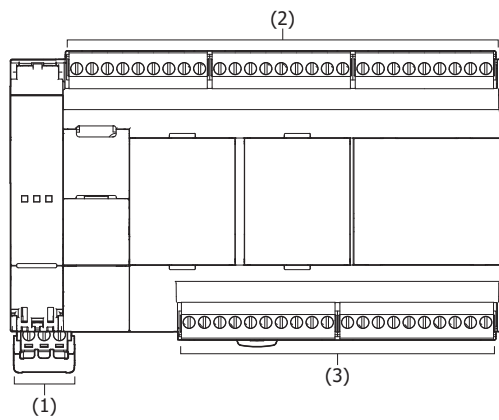

External Power 12V DC

⊞ : Fuse

⊞ : Load

(2) Input terminals

DC Sink Input Wiring

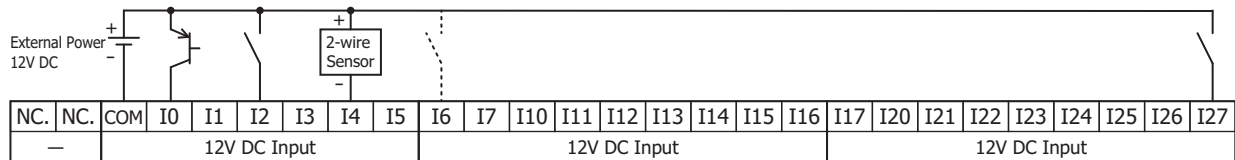

DC Source Input Wiring

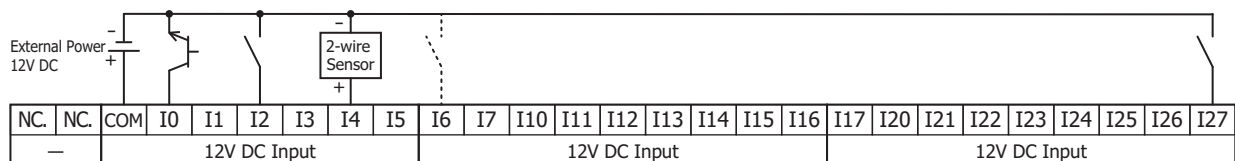

2: PRODUCT SPECIFICATIONS

(3) Output terminals

Relay Output: FC6A-C40R1DE, FC6A-C40R4DE, FC6A-C40R1DEJ, FC6A-C40R4DEJ

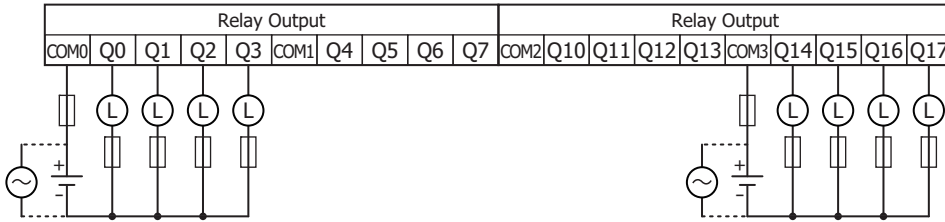

Transistor Sink Output: FC6A-C40K1DE, FC6A-C40K4DE, FC6A-C40K1DEJ, FC6A-C40K4DEJ

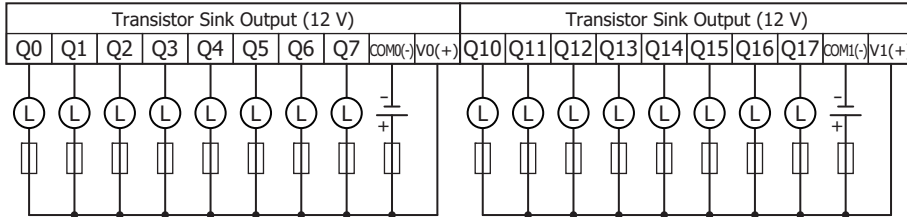

Transistor Protection Source Output: FC6A-C40P1DE, FC6A-C40P4DE, FC6A-C40P1DEJ, FC6A-C40P4DEJ

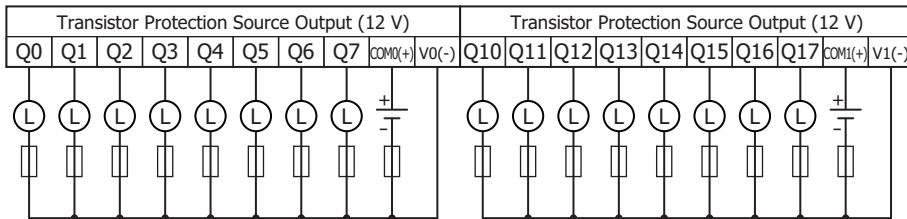

Other Inputs and Ports

■ **All-in-One CPU module**

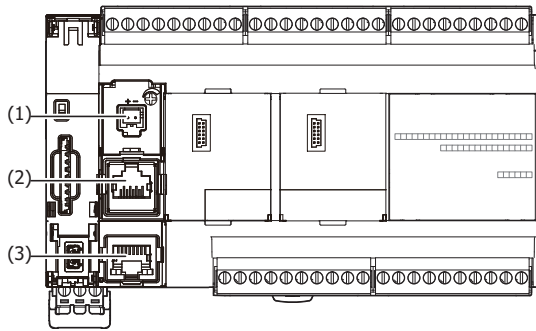

(1) Analog input

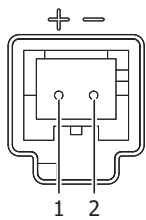

No.	Signal Wire	Cable Color
1	AN(+)	Red
2	AN(-)	Black

(2) Serial Port 1

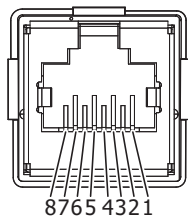

No.	Signal Wire (RS-232C)	Signal Wire (RS-485)
1	RD	—
2	SD	—
3	ER	—
4	—	A
5	—	B
6	DR	—
7	—	—
8	SG	SG
Shell*1	Shield	Shield

*1 Shell is connected to PE or FE on the power supply terminals.

Note: The recommended cable to connect to this port is the FC6A-KC1C or the FC6A-KC2C. For details, see "Cables" on page A-14.

(3) Ethernet Port 1

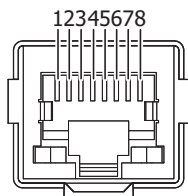

No.	Signal Wire
1	TPO+
2	TPO-
3	TPI+
4	—
5	—
6	TPI-
7	—
8	—
Shell*1	Shield

*1 Shell is connected to PE or FE on the power supply terminals.

2: PRODUCT SPECIFICATIONS

■ CAN J1939 All-in-One CPU module

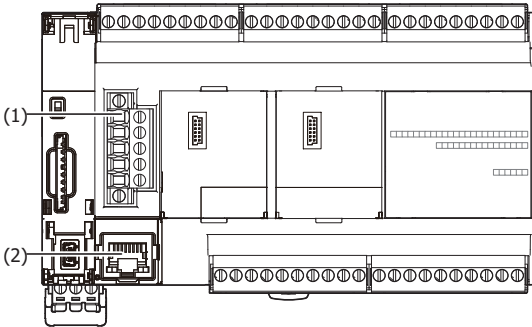

(1) CAN port

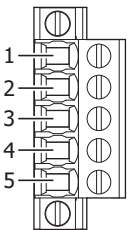

No.	Signal Wire	Description
1	SG	CAN external power supply (-)
2	CAN_L	CAN_L bus line (dominant low)
3	CAN_SHLD	CAN cable shield*1
4	CAN_H	CAN_H bus line (dominant high)
5	(V+)	CAN external power supply (+). (This port is not used with the FC6A Series MICROSmart.)

*1 Internally connected to the SG via a resistor and capacitor connected in a series. (R = 1 Ω, 0.68 μF)
Applicable connector: FC6A-PMTE05PN02 (screw fastened type), FC6A-PMSE05PN02 (push-in type)

(2) Ethernet Port 1

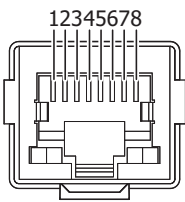

No.	Signal Wire
1	TPO+
2	TPO-
3	TPI+
4	—
5	—
6	TPI-
7	—
8	—
Shell*1	Shield

*1 Shell is connected to PE or FE on the power supply terminals.

Plus CPU module

Part Names and Functions

Example:
FC6A-D16*1CEE

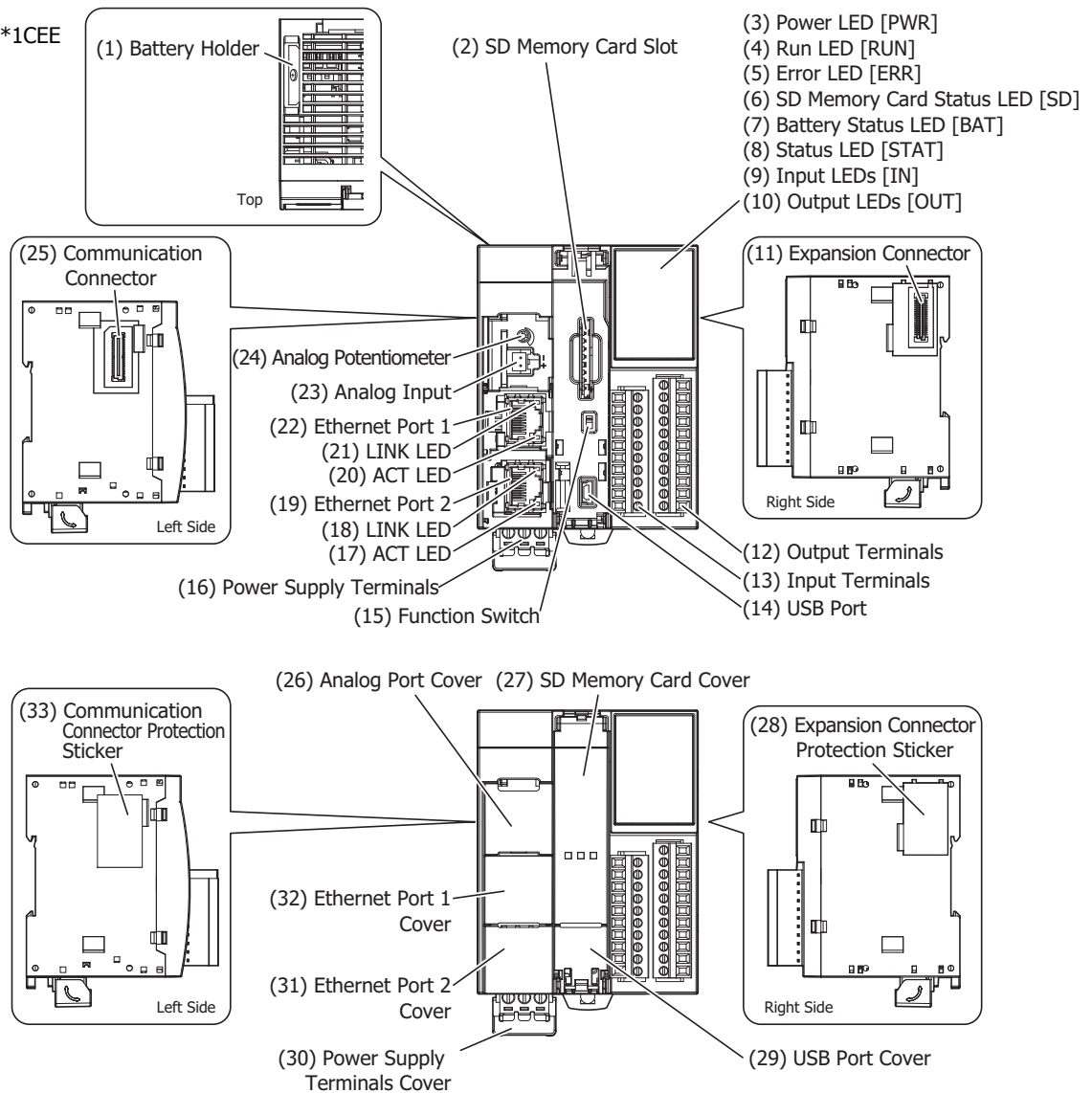

The content in brackets is the LED indicator name on the FC6A Series MICROSmart.

LED Indicators

Plus 16-I/O Type				Plus 32-I/O Type			
	IN	OUT		IN	OUT		
(3) — PWR	<input type="checkbox"/> 0	<input type="checkbox"/> 0	(9) (10)	(3) — PWR	<input type="checkbox"/> 0	<input type="checkbox"/> 0	(9) (10)
(4) — RUN	<input type="checkbox"/> 1	<input type="checkbox"/> 1		(4) — RUN	<input type="checkbox"/> 1	<input type="checkbox"/> 1	
(5) — ERR	<input type="checkbox"/> 2	<input type="checkbox"/> 2		(5) — ERR	<input type="checkbox"/> 2	<input type="checkbox"/> 2	
(6) — SD	<input type="checkbox"/> 3	<input type="checkbox"/> 3		(6) — SD	<input type="checkbox"/> 3	<input type="checkbox"/> 3	
(7) — BAT	<input type="checkbox"/> 4	<input type="checkbox"/> 4		(7) — BAT	<input type="checkbox"/> 4	<input type="checkbox"/> 4	
(8) — STAT	<input type="checkbox"/> 5	<input type="checkbox"/> 5		(8) — STAT	<input type="checkbox"/> 5	<input type="checkbox"/> 5	
	<input type="checkbox"/> 6	<input type="checkbox"/> 6			<input type="checkbox"/> 6	<input type="checkbox"/> 6	
	<input type="checkbox"/> 7	<input type="checkbox"/> 7			<input type="checkbox"/> 7	<input type="checkbox"/> 7	
				<input type="checkbox"/> 10	<input type="checkbox"/> 10		
				<input type="checkbox"/> 11	<input type="checkbox"/> 11		
				<input type="checkbox"/> 12	<input type="checkbox"/> 12		
				<input type="checkbox"/> 13	<input type="checkbox"/> 13		
				<input type="checkbox"/> 14	<input type="checkbox"/> 14		
				<input type="checkbox"/> 15	<input type="checkbox"/> 15		
				<input type="checkbox"/> 16	<input type="checkbox"/> 16		
				<input type="checkbox"/> 17	<input type="checkbox"/> 17		

2: PRODUCT SPECIFICATIONS

(1) Battery Holder

This holder is for installing the backup battery.

(2) SD Memory Card Slot

This slot is used to insert the SD memory card.

(3) Power LED [PWR]

This LED turns on when the power is supplied to the CPU module.

(4) Run LED [RUN]

This LED turns on while the CPU module is running the user program.

This LED flashes when using certain functions while the user program is running.

LED	Status
ON	<ul style="list-style-type: none"> While the CPU module is running the user program
Slow flashing (1 s cycle)	<ul style="list-style-type: none"> When executing the forced I/O function while the user program is running
Quick flashing (100 ms cycle)	<ul style="list-style-type: none"> While the CPU module is in USB boot When executing the forced I/O function while the user program is stopped

(5) Error LED [ERR]

This LED turns on when an error occurs in the CPU module.

(6) SD Memory Card Status LED [SD]

This LED turns on or flashes when the SD memory card is being read or written.

LED	Status
OFF	<ul style="list-style-type: none"> When the SD memory card is not inserted When an unsupported or unformatted SD memory card was inserted Unmount SD memory card (M8072) is on, so the SD memory card has been unmounted When the FC6A Series MICROSmart power is off
ON	<ul style="list-style-type: none"> The standby state where the SD memory card can be written or read
Slow flashing (1 s cycle)	<ul style="list-style-type: none"> When the FC6A Series MICROSmart is recognizing the SD memory card Unmount SD memory card (M8072) is turned on and the FC6A Series MICROSmart is unmounting the SD memory card
Quick flashing (100 ms cycle)	<ul style="list-style-type: none"> Reading or writing the SD memory card

(7) Battery Status LED [BAT]

This LED turns on or flashes when the backup battery level is low.

LED	Condition	Battery Status	
OFF	Battery voltage (D8056) > 2,300	Normal	Sufficient battery level.
Flashing (1 s cycle)	$2,300 \geq$ battery voltage (D8056) > 2,000	Warning	Low battery level. Replace the battery.
ON	$2,000 \geq$ battery voltage (D8056)	Dead battery	The battery is almost dead. Or no battery.

(8) Status LED [STAT]

This LED can be turned on or off in the user program.

(9) Input LEDs [IN]

These LEDs turn on when the corresponding input is on.

(10) Output LEDs [OUT]

These LEDs turn on when the corresponding output is on.

(11) Expansion Connector

This connector is used to connect an expansion module.

(12) Output Terminals

These terminals connect output devices such as electromagnetic switches and solenoid valves. The CPU module is available in the relay output type (240V AC: 2 A, 30V DC: 2 A), the transistor sink output type (0.5 A), and the transistor protection source output type (0.5 A).

(13) Input Terminals

These terminals connect input devices such as push buttons and limit switches. DC inputs are both sinks and sources.

(14) USB Port

A mini-B type USB 2.0 connector. A USB cable can be attached to the FC6A Series MICROSmart and connected to a PC to download and upload user programs using WindLDR.

(15) Function Switch

This switch turns M8073 on or off (default setting: 0 (off)).

You can run or stop the CPU module with this switch by enabling **Run/Stop PLC by Function Switch** in WindLDR (default setting: enabled).

For details about the function switch, see "Function Switch Configuration" on page 5-11.

(16) Power Supply Terminals

These terminals are used to supply 24V DC power to the CPU module.

(17) ACT LED

This LED flashes when sending or receiving data while the LINK LED (18) is on.

(18) LINK LED

This LED is on when a network-compatible device is connected to Ethernet port 2.

(19) Ethernet Port 2

This port allows Ethernet communication with connected devices that are equipped with an Ethernet interface.

(20) ACT LED

This LED flashes when sending or receiving data while the LINK LED (21) is on.

(21) LINK LED

This LED is on when a network-compatible device is connected to Ethernet port 1.

(22) Ethernet Port 1

This port allows Ethernet communication with connected devices that are equipped with an Ethernet interface.

(23) Analog Input

The connector for the analog input.

(24) Analog Potentiometer

A potentiometer for setting a timer or other device. This allows an analog value used in the user program to be set without the use of an external device.

(25) Communication Connector

This connector is used to connect the HMI module and cartridge base module.

(26) Analog Port Cover

A removable cover that protects the analog input and analog potentiometer. When using these, remove the analog port cover.

(27) SD Memory Card Cover

An openable cover that protects the SD memory card and function switch. Open the SD memory card cover when inserting or ejecting the SD memory card or when using the function switch.

(28) Expansion Connector Protection Sticker

This sticker protects the expansion connector. Remove the expansion connector protection sticker when connecting an expansion module.

(29) USB Port Cover

An openable cover that protects the USB port. When using the USB port, open the USB port cover.

(30) Power Supply Terminals Cover

An openable cover that protects the power supply terminals. Open the power supply terminals cover when removing and attaching the power supply terminals.

Note: The FC6A-D16R4CEE, FC6A-D16K4CEE, FC6A-D16P4CEE, FC6A-D32K4CEE, and FC6A-D32P4CEE do not have a power supply terminal cover.

2: PRODUCT SPECIFICATIONS

(31) Ethernet Port 2 Cover

A removable cover that protects Ethernet Port 2. When using the Ethernet port, remove the Ethernet Port 2 cover.

(32) Ethernet Port 1 Cover

A removable cover that protects Ethernet Port 1. When using the Ethernet port, remove the Ethernet Port 1 cover.

(33) Communication Connector Protection Sticker

This sticker protects the communication connector. Remove the communication connector protection sticker when connecting the HMI module or cartridge base module.

Power Supply Specifications

■ **24V DC Power Type**

Type No.	FC6A-D16R1CEE, FC6A-D16R4CEE, FC6A-D16K1CEE, FC6A-D16K4CEE, FC6A-D16P1CEE, FC6A-D16P4CEE, FC6A-D32K3CEE, FC6A-D32K4CEE, FC6A-D32P3CEE, FC6A-D32P4CEE		
Rated Power Voltage	24V DC		
Voltage Fluctuation Range	20.4 to 28.8V DC (including ripple)		
Maximum Power Consumption	Standalone	When Maximum Load is Connected	
	FC6A-D16R1CEE/ FC6A-D16R4CEE	2.88 W (24V DC)	18.24 W (24V DC)
	FC6A-D16K1CEE/ FC6A-D16K4CEE	2.88 W (24V DC)	18.24 W (24V DC)
	FC6A-D16P1CEE/ FC6A-D16P4CEE	2.88 W (24V DC)	18.24 W (24V DC)
	FC6A-D32K3CEE/ FC6A-D32K4CEE	3.36 W (24V DC)	18.72 W (24V DC)
	FC6A-D32P3CEE/ FC6A-D32P4CEE	3.36 W (24V DC)	18.72 W (24V DC)
Allowable Momentary Power Interruption	10 ms or longer (when rated power supply voltage)		
Withstand Voltage	Between power and FE terminals: 500V AC, 1 minute		
	Between input and FE terminals: 500V AC, 1 minute		
	Between transistor output and FE terminals: 500V AC, 1 minute		
	Between relay output and FE terminals: 2,300V AC, 1 minute		
	Between power and input terminals: 500V AC, 1 minute		
	Between power and transistor output terminals: 500V AC, 1 minute		
	Between power and relay output terminals: 2,300V AC, 1 minute		
	Between input and transistor output terminals: 500V AC, 1 minute		
Insulation Resistance	Between power and relay output terminals: 2,300V AC, 1 minute		
	Between power and FE terminals: 100 MΩ or higher (500V DC insulation resistance tester)		
	Between input and FE terminals: 100 MΩ or higher (500V DC insulation resistance tester)		
	Between transistor output and FE terminals: 100 MΩ or higher (500V DC insulation resistance tester)		
	Between relay output and FE terminals: 100 MΩ or higher (500V DC insulation resistance tester)		
	Between power and input terminals: 100 MΩ or higher (500V DC insulation resistance tester)		
	Between power and transistor output terminals: 100 MΩ or higher (500V DC insulation resistance tester)		
	Between power and relay output terminals: 100 MΩ or higher (500V DC insulation resistance tester)		
Inrush Current	35 A maximum		
Isolation	Between power terminal and internal circuit: Transformer isolated		
Ground	D-type ground (Class 3 ground)		
Grounding Wire	See "Recommended Ferrule List" on page 3-46.		
Power Supply Wire	See "Recommended Ferrule List" on page 3-46.		
Effect of Improper Power Supply Connection	Reverse polarity: Normal operation		
	Improper voltage or frequency: Permanent damage may be caused		
	Improper lead connection: Permanent damage may be caused		

2: PRODUCT SPECIFICATIONS

Weight (approx.)	FC6A-D16R1CEE	290 g
	FC6A-D16R4CEE	280 g
	FC6A-D16K1CEE	275 g
	FC6A-D16K4CEE	265 g
	FC6A-D16P1CEE	275 g
	FC6A-D16P4CEE	265 g
	FC6A-D32K3CEE	255 g
	FC6A-D32K4CEE	255 g
	FC6A-D32P3CEE	255 g
	FC6A-D32P4CEE	255 g

Function Specifications

■ **CPU Module Performance**

Type No.		FC6A-D16R1CEE, FC6A-D16R4CEE FC6A-D16K1CEE, FC6A-D16K4CEE FC6A-D16P1CEE, FC6A-D16P4CEE	FC6A-D32K3CEE, FC6A-D32K4CEE FC6A-D32P3CEE, FC6A-D32P4CEE	
Program Capacity*1	Program Data	800,000 bytes (100,000 steps)		
	Comment Data	384,000 bytes		
I/O Expansion	Basic Expansion	7		
	Expansion Interface	8		
	Cartridges*3	3		
I/O Points	Basic	Input	8	16
		Output	8	16
	Basic Expansion*2	224		
	Expansion Interface*4	256		
	Cartridges*3	12		
Expanded I/O with Expansion Interface Remote Master/Slave Modules		I/O in the system can be expanded up to a maximum of 63 modules using expansion interface modules (remote master/slave) (I/O points: maximum 2,016 points). For details, see "Expansion Interface Modules (Remote Master/Slave)" on page 2-146.		
User Program Download		1,000 times		
Control System		Stored program system		
Instructions	Basic Instructions	42 type		
	Advanced Instructions	124 type		
Processing Speed	Basic Instruction	0.021 ms/1,000 steps		
	END Processing	1 ms		
Internal Relay		15,400		
Shift Register		256		
Data Register		60,000		
Counter (adding, reversible)		512		
Timer (1 ms, 10 ms, 100 ms, 1 s)		2,000		

*1 1 step is equivalent to 8 bytes.

*2 There are limitations on the maximum number of outputs that can be simultaneously turned on. For details, see "Connection Restrictions When Expanding the PLC" on page 3-37.

*3 A maximum of three cartridges can be used by connecting the cartridge base module and HMI module.

*4 The maximum number of expansion modules that can be connected can be increased by using the expansion interface module. For details, see "Expansion Interface Modules" on page 2-143.

Backup Function

Backup Data	RAM (internal relays, shift registers, counters, data registers*1)*2, clock
Backup Battery	Lithium ion primary cell (A battery is included with the product. The model of battery to be included with the product cannot be specified.) Panasonic: BR2032/CR2032A/CR2032B, Murata: CR2032X/CR2032W
Battery Life	Guaranteed 1 year, replacement recommended every 4 years (+25°C)*3
Replaceability	Replace within 1 minute after power off (recommended)*4

*1 D70000 to D269999 cannot be designated as "Keep." Data register values are kept when you switch the PLC from Stop to Run, but those values are cleared at power up.

*2 To prepare for when the battery dies, the contents of RAM (internal relays, shift registers, counters, and data registers) can be saved to non-volatile memory. For how to save the contents of RAM, see "SD Memory Card" on page 11-1.

*3 The battery is primarily consumed by backup current while unpowered. However, the ambient environment (temperature and humidity) while unpowered and powered also affects consumption. In particular, battery life is greatly reduced in a high-temperature and high-humidity environment, so replacement is recommended every year when the effect of the ambient environment (temperature and humidity) while unpowered and powered is included.

*4 Replacement while powered and replacement while power is supplied from the USB bus are also possible. For the replacement method, see "Replacing the Backup Battery" on page 3-34.

2: PRODUCT SPECIFICATIONS

Clock Function

Accuracy	±30 seconds/month at 25°C
-----------------	---------------------------

Self-diagnostic Functions

- Keep data
- User program (ROM) CRC check
- Timer/counter preset value change check
- User program syntax check
- User program execution check
- Watchdog timer check
- User program download check
- Power failure
- Clock error
- Data link connection check
- Expansion bus initialization check
- System check
- SD memory card transfer check
- SD memory card access check

Input Filter

0 ms (no filter), 3 to 15 ms (selectable in increments of 1 ms)

Type No.	FC6A-D16R1CEE, FC6A-D16R4CEE FC6A-D16K1CEE, FC6A-D16K4CEE FC6A-D16P1CEE, FC6A-D16P4CEE	FC6A-D32K3CEE, FC6A-D32K4CEE FC6A-D32P3CEE, FC6A-D32P4CEE
I0 to I7	0 ms (no filter), 3 to 15 ms (selectable in increments of 1 ms)	
I10 to I13	—	0 ms (no filter), 3 to 15 ms selectable (in 1 ms increments)
I14 to I17	—	3 ms fixed

Catch Input/Interrupt Input

Type No.	FC6A-D16R1CEE, FC6A-D16R4CEE FC6A-D16K1CEE, FC6A-D16K4CEE FC6A-D16P1CEE, FC6A-D16P4CEE	FC6A-D32K3CEE, FC6A-D32K4CEE FC6A-D32P3CEE, FC6A-D32P4CEE
High-speed 6 Points (I0, I1, I3, I4, I6, I7)	Minimum turn on pulse width: 5 μs Minimum turn off pulse width: 5 μs	
Medium-speed 3 Points (I11, I12, I13)	—	Minimum turn on pulse width: 35 μs Minimum turn off pulse width: 35 μs

High-speed Counter

Maximum Counter Frequency and Points	Single-phase, two-phase common: 100 kHz (single-phase 6 points max, two-phase 3 points max)
Count Range	Single-phase, two-phase common: 0 to 4,294,967,295 (32 bits)
Operation Mode	Rotary encoder mode, adding counter mode, frequency measurement mode

Pulse Output (Transistor Output Type Only)

Points	High-speed Output (100 kHz)	4
---------------	------------------------------------	---

Function Switch

Points	1 (2 position slide switch)
Function	Program run/stop The function can be set in the function area settings (default setting: enabled).

Analog Potentiometer

Points	1
Data Resolution	0 to 1,000

Analog Input

Points	1
Input Range	0 to 10 V
Data Resolution	0 to 4,095
Input Impedance	Approx. 100 kΩ
Error	±1% of full scale (±5% of full scale when noise is applied)

Input Delay Time	12 ms (including the software filter)
Maximum Allowed Steady Load	13 V
Isolation	Not isolated
Cable	Unshielded cable 1 m (included with the product)

Run/Stop Methods

- Power on/off
- WindLDR RUN/STOP command
- Function switch operation
- Special internal relay (M8000) operation
- Operation of stop input and reset input

USB Port

Points	1
Communication Type	USB2.0 Full speed, CDC class
Communication Functions	Capable of maintenance communication with a PC
Connector	USB mini-B
Isolation between Internal Circuit	Not isolated
Available Function when FC6A is Powered by USB	Downloading/uploading user programs, downloading system software, data file manager

Ethernet Port

Points	2 (When the HMI module is connected, this can be expanded by 1 point with the Ethernet port that has the web server function.)
Communication Type	IEEE 802.3 compliant
Communication Speed	10BASE-T, 100BASE-TX
Communication Functions	Port 1 Maintenance communication server, User communication server/client (TCP/UDP), Modbus TCP server/client, PING, SNTP, e-mail, web server, FTP server/client, BACnet/IP
	Port 2 Maintenance communication server, User communication server/client (TCP/UDP), Modbus TCP server/client, PING, EtherNet/IP communication
Connector	RJ45 (Auto MDI/MDI-X compatible)
Cable	CAT 5 or higher, STP
Maximum Cable Length	100 m
Isolation between Internal Circuit	Pulse transformer isolated

SD Memory Card Slot

Points	1
Supported SD Card	SD memory cards (max 2 GB), SDHC memory cards (max 32 GB)
File System	FAT16, FAT32
Function	Downloading/uploading user programs, saving log data, recipes, downloading system software, saving web pages
Insertion/Removal Durability	2,000 times

Communication Connector

Cartridge Base Module Connection*1	No. of Modules	1 (Two cartridges can be connected to the cartridge base module when it is connected to the Plus CPU module.)
HMI Module Connection*1	No. of Modules	1 (One cartridge can be connected to the HMI module when it is connected to the Plus CPU module.)

*1 All devices that are connectable to the communication connector cannot be used in expanded ambient operating temperatures (-25 to -10°C and 55 to 65°C). Do not connect these devices when the product is used in expanded ambient operating temperatures.

2: PRODUCT SPECIFICATIONS

DC Input Specifications

■ 24V DC Power Type

Type No.		FC6A-D16R1CEE, FC6A-D16R4CEE FC6A-D16K1CEE, FC6A-D16K4CEE FC6A-D16P1CEE, FC6A-D16P4CEE	FC6A-D32K3CEE, FC6A-D32K4CEE FC6A-D32P3CEE, FC6A-D32P4CEE	
Rated Input Voltage		24V DC shared sink/source		
Input Voltage Range		20.4 to 28.8V DC		
Rated Input Current	I0, I1, I3, I4, I6, I7	5 mA/point (at 24V DC)		
	I2, I5, I10 to I17	7 mA/point (at 24V DC)		
Terminal Arrangement		See "24V DC Power Type" on page 2-64.		
Input Impedance	I0, I1, I3, I4, I6, I7	4.9 kΩ		
	I2, I5, I10 to I17	3.4 kΩ		
Input Delay Time	Turn ON Time	I0, I1, I3, I4, I6, I7	5 μs + software filter setting	
		I2, I5	35 μs + software filter setting	
		I10 to I13	—	35 μs + software filter setting
		I14 to I17	—	4.1 ms
	Turn OFF Time	I0, I1, I3, I4, I6, I7	5 μs + software filter setting	
		I2, I5	35 μs + software filter setting	
		I10 to I13	—	35 μs + software filter setting
		I14 to I17	—	4.1 ms
Quantity of Inputs		8 points in 1 common line	16 points in 1 common line	
Isolation	Between Input Terminals	Not isolated		
	Internal circuit	Photocoupler isolated		
Input Type		Type1 (IEC61131-2)		
External Load for I/O Interconnection		Not needed		
Signal Determination Method		Static		
Effect of Improper Input Connection		Even if wiring for sink or source connection is incorrect, no damages are caused. However, if high voltage is applied that exceeds the input voltage range, there is a risk of permanent damage.		
Cable Length		3 m		
I/O Terminal Connector	Type	See "24V DC Power Type" on page 2-64.		
	Insertion/Removal Durability	100 times minimum		

Operating Ranges

The operating range of Type 1 (IEC 61131-2) DC input is as follows.

Input Voltage (V DC) I0, I1, I3, I4, I6, I7

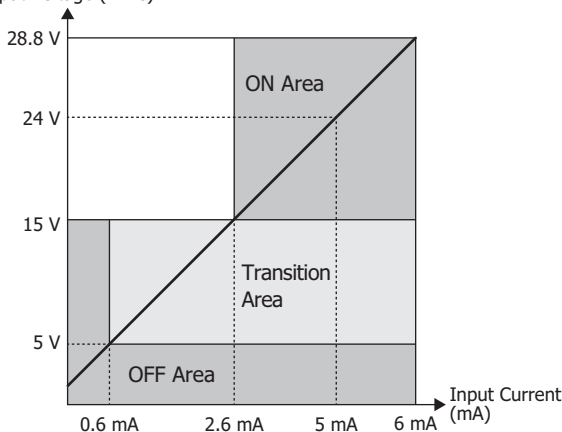

Input Voltage (V DC) I2, I5, I10 to I17

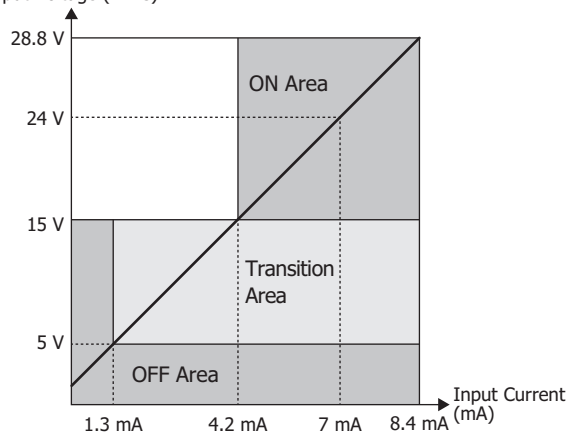

Input Internal Circuit

I0, I1, I3, I4, I6, I7 4.7 kΩ

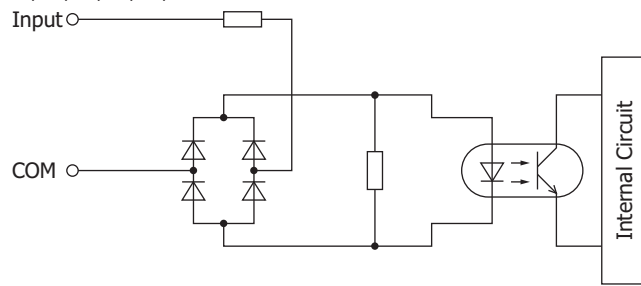

I2, I5, I10 to I17 3.3 kΩ

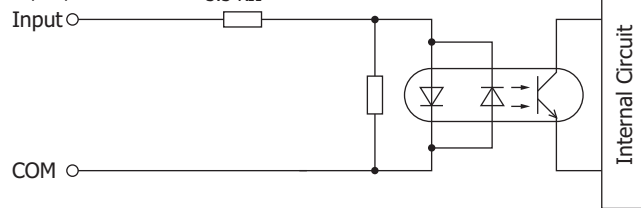

2: PRODUCT SPECIFICATIONS

Relay Output Specifications

■ 24V DC Power Type

Type No.		FC6A-D16R1CEE, FC6A-D16R4CEE
No. of Outputs		8
Output Points per Common Line	COM1	4
	COM2	4
Terminal Arrangement		See "24V DC Power Type" on page 2-64.
Output Type		1a contact
Maximum Load Current *1	1	2 A maximum
	1 Common	7 A maximum
Minimum Switching Load		1.0 mA/5.0V DC (reference value)
Initial Contact Resistance		30 mΩ or lower
Electrical Life		100,000 operations minimum (rated load 1,800 operations/hour)
Mechanical Life		20,000,000 operations minimum (no load 18,000 operations/hour)
Rated Load *1		240V AC 2 A, 30V DC 2 A
Withstand Voltage	Between Output Terminal and FE	2,300V AC, 1 minute
	Between Output Terminal and Internal Circuit	2,300V AC, 1 minute
	Between Output Terminals (COMs)	2,300V AC, 1 minute
I/O Terminal Connector	Type	See "24V DC Power Type" on page 2-64.
	Insertion/Removal Durability	100 times minimum

*1 Values for resistive/inductive load.

Output Delay

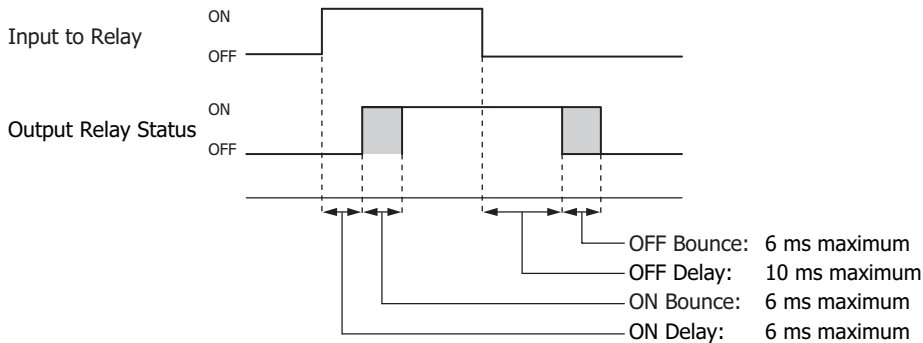

Transistor Sink Output Specifications

■ **24V DC Power Type**

Type No.		FC6A-D16K1CEE, FC6A-D16K4CEE	FC6A-D32K3CEE, FC6A-D32K4CEE
Output Points		8	16
Output Points per Common Line		8	16
Rated Load Voltage		24V DC	
Operating Load Voltage Range		20.4 to 28.8V DC	
Terminal Arrangement		See "24V DC Power Type" on page 2-64.	
Maximum Load Current	1	0.5 A maximum	0.1 A maximum
	1 Common	4 A maximum	1.6 A maximum
Voltage Drop (ON Voltage)		1 V or less, voltage between COM and output terminal when ON	
Maximum Inrush Current		1 A	0.2 A
Leakage Current		0.1 mA maximum	
Clamping Voltage		39 V±1 V	
Maximum Lamp Load		12 W	2.4 W
Inductive Load		L/R = 10 ms (28.8V DC, 1 Hz)	
External Current Draw		100 mA maximum, 24V DC (+V terminal supply power)	
Isolation	Between Output Terminal and Internal Circuit	Photocoupler isolated	
	Between Output Terminals	Not isolated	
I/O Terminal Connector	Type	See "24V DC Power Type" on page 2-64.	
	Insertion/Removal Durability	100 times minimum	
Output Delay	Turn ON Time	Q0 to Q7: 5 μs or less	Q0 to Q7: 5 μs or less Q10 to Q17: 300 μs or less
	Turn OFF Time	Q0 to Q7: 5 μs or less	Q0 to Q7: 5 μs or less Q10 to Q17: 300 μs or less

Output Internal Circuit

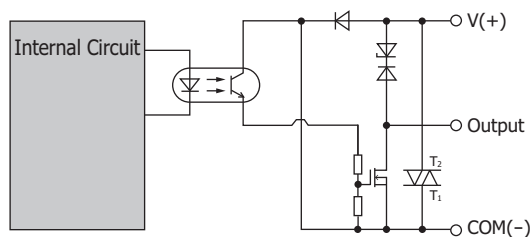

2: PRODUCT SPECIFICATIONS

Transistor Protection Source Output Specifications

■ 24V DC Power Type

Type No.	FC6A-D16P1CEE, FC6A-D16P4CEE	FC6A-D32P3CEE, FC6A-D32P4CEE
Output Points	8	16
Output Points per Common Line	8	16
Rated Load Voltage	24V DC	
Operating Load Voltage Range	20.4 to 28.8V DC	
Terminal Arrangement	See "24V DC Power Type" on page 2-64.	
Maximum Load Current	1	0.5 A maximum
	1 Common	4 A maximum
Maximum Load Current	0.1 A maximum	1.6 A maximum
Voltage Drop (ON Voltage)	1 V or less, voltage between COM and output terminal when ON	
Maximum Inrush Current	1 A	0.2 A
Leakage Current	0.1 mA maximum	
Clamping Voltage	39 V±1 V	
Maximum Lamp Load	12 W	2.4 W
Inductive Load	L/R = 10 ms (28.8V DC, 1 Hz)	
External Current Draw	100 mA maximum, 24V DC (-V terminal supply power)	
Output Protection Functions	Overcurrent protection function (not a thermal shutdown function). Overcurrent detected with 4 outputs as 1 group. (Group 1: Q0 to Q3, Group 2: Q4 to Q7, Group 3: Q10 to Q13, Group 4: Q14 to Q17) When overcurrent is detected, the 4 outputs in the corresponding group are turned off for a fixed period (1 s). When overcurrent is detected, a special internal relay turns on (M8172 to M8175) and the error LED [ERR] turns on.	
Output Current Limit Value	1.0 to 2.0 A	0.2 to 0.3 A
Isolation	Between Output Terminal and Internal Circuit	Photocoupler isolated
	Between Output Terminals	Not isolated
I/O Terminal Connector	Type	See "24V DC Power Type" on page 2-64.
	Insertion/Removal Durability	100 times minimum
Output Delay	Turn ON Time	Q0 to Q7: 5 μs or less Q10 to Q17: 300 μs or less
	Turn OFF Time	Q0 to Q7: 5 μs or less Q10 to Q17: 300 μs or less

Output Internal Circuit

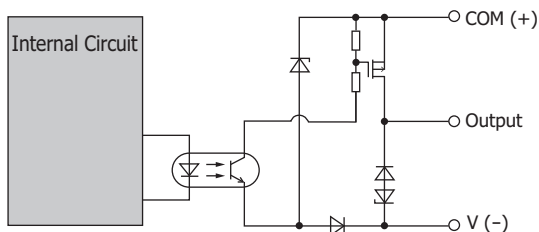

(The overcurrent detection circuit has been omitted.)

Ambient Temperature, Input Voltage, Output Voltage, I/O Simultaneous ON Ratio

When the FC6A Series MICROSmart is used in an ambient temperature of 45°C or higher, reduce the input voltage and I/O utilization (simultaneous ON ratio: a%) according to the following diagrams. However, the following diagrams show the temperature conditions when the FC6A Series MICROSmart is normally installed.

Note: Normally installed means the state in the diagram in "Normal Installation State" on page 3-1.

The usage conditions will also change according to the installation state. For details, see "Installation Location" on page 3-1.

■ **Relay Output Type**

(FC6A-D16R1CEE, FC6A-D16R4CEE)

Reduce the input voltage, output voltage, and I/O simultaneous ON ratio as shown in the following diagrams.

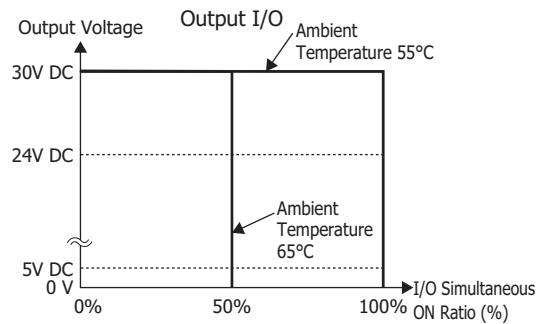
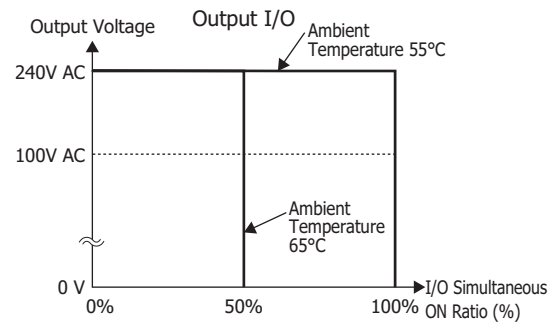
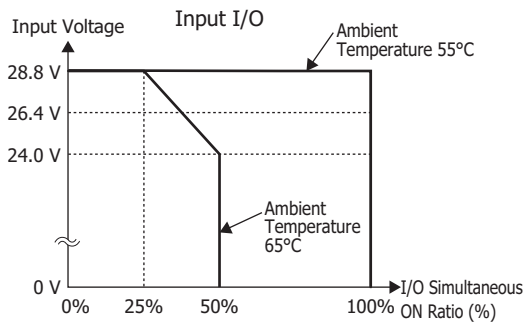

■ **Transistor Output Type**

(FC6A-D16K1CEE, FC6A-D16P1CEE, FC6A-D32K1CEE, FC6A-D32P1CEE, FC6A-D16K4CEE, FC6A-D16P4CEE, FC6A-D32K4CEE, FC6A-D32P4CEE)

Reduce the input voltage, output voltage, and I/O simultaneous ON ratio as shown in the following diagrams.

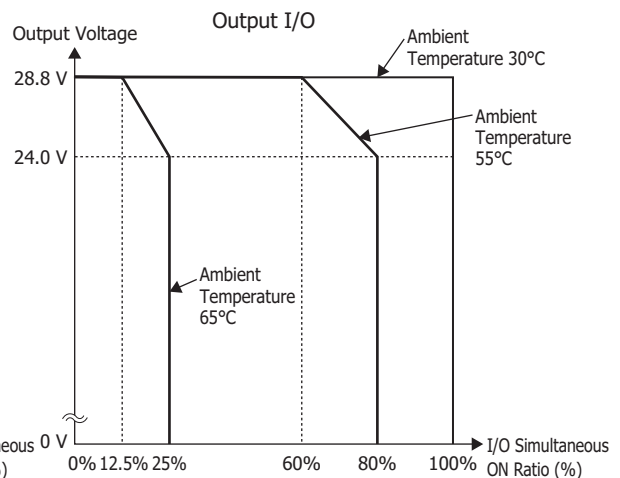
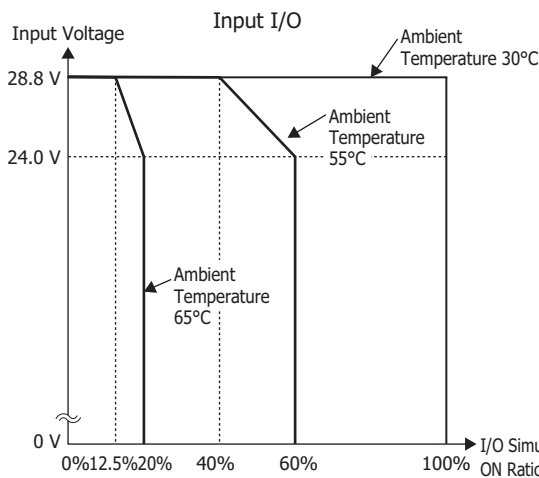

2: PRODUCT SPECIFICATIONS

Terminal Arrangement and Wiring Examples

■ 24V DC Power Type

Plus 16-I/O type: Screw fastened type: FC6A-C16R1CEE, FC6A-D16K1CEE, FC6A-D16P1CEE
 Push-in type: FC6A-D16R4CEE, FC6A-D16K4CEE, FC6A-D16P4CEE

Applicable connector

(1) Power supply terminals	Screw fastened type	FC6A-PMTD03PN02	
	Push-in type	FC6A-PMSDC03PN02	
(2) Input terminals	Screw fastened type	FC6A-PMTCN10PN02	
	Push-in type	FC6A-PMSCN10PN02	
(3) Output terminals	Relay output	Screw fastened type	FC6A-PMTCR11PN02
		Push-in type	FC6A-PMSCR11PN02
	Transistor sink output	Screw fastened type	FC6A-PMTCK11PN02
		Push-in type	FC6A-PMSCK11PN02
	Transistor protection source output	Screw fastened type	FC6A-PMTCP11PN02
		Push-in type	FC6A-PMSCP11PN02

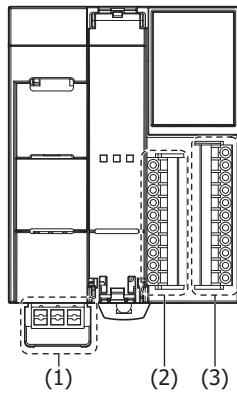
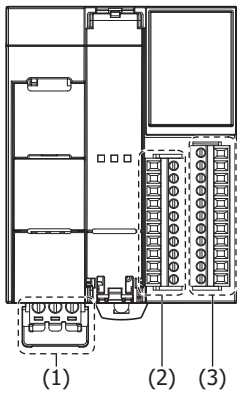

Screw fastened type

Push-in type

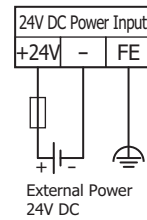

(1) Power supply terminals



 : Fuse
 : Load

(2) Input terminals

DC Sink Input Wiring

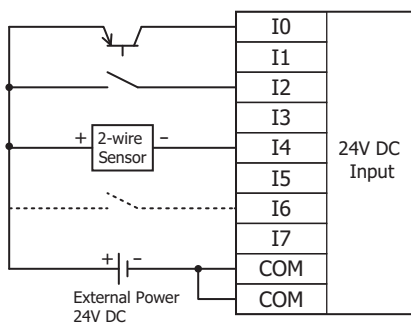

DC Source Input Wiring

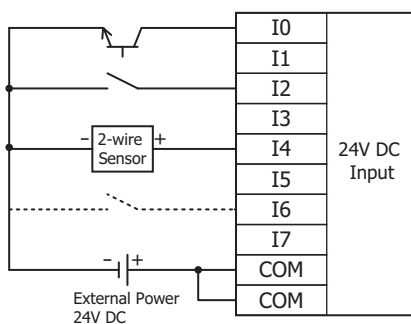

(3) Output terminals

Relay Output:

FC6A-D16R1CEE, FC6A-D16R4CEE

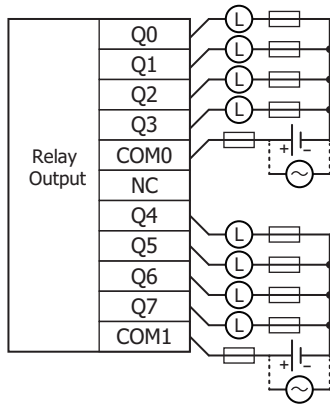

Transistor Sink Output:

FC6A-D16K1CEE, FC6A-D16K4CEE

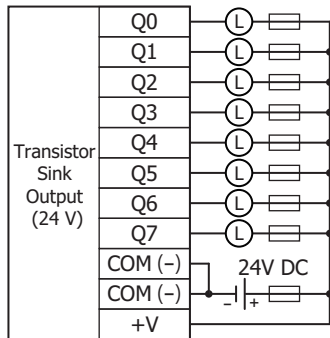

Transistor Protection Source Output:

FC6A-D16P1CEE, FC6A-D16P4CEE

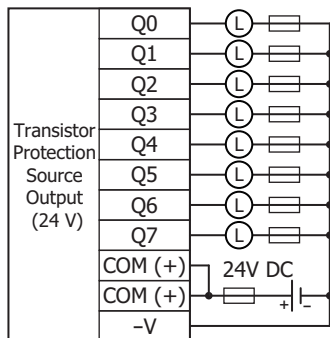

2: PRODUCT SPECIFICATIONS

Plus 32-I/O type: **Screw fastened type:** FC6A-D32K3CEE, FC6A-D32P3CEE
Push-in type: **FC6A-D32K4CEE, FC6A-D32P4CEE**

Applicable connector

(1) Power supply terminals	Screw fastened type	FC6A-PMTD03PN02
	Push-in type	FC6A-PMSDC03PN02
(2) Input terminals		FC4A-PMC20PN02
(3) Output terminals		FC4A-PMC20PN02

Screw fastened type

Push-in type

(1) Power supply terminals

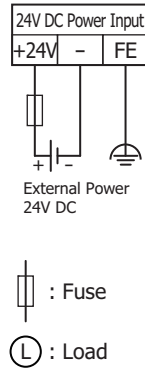
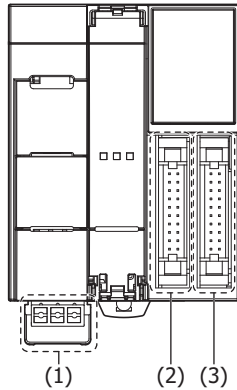
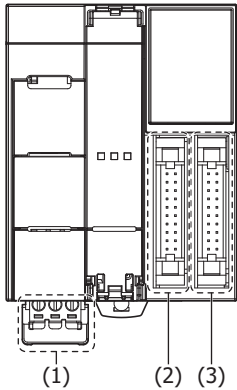

(2) Input terminals

The two COM lines are each connected in the module.

For wiring precautions, see "Input/Output Wiring" on page 3-18. For the connector cable, see "Cables" on page A-14.

DC Sink Input Wiring

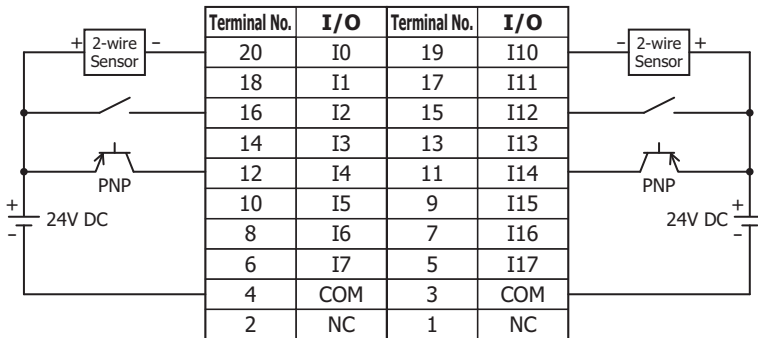

DC Source Input Wiring

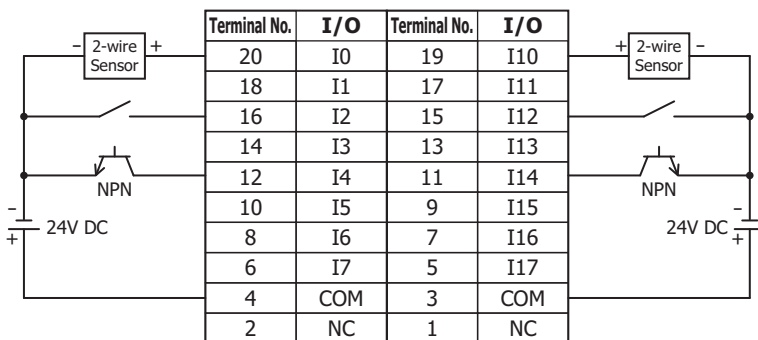

(3) Output terminals

The two COM(+) and COM(-) lines are each connected in the module.

The two +V and -V lines are each connected in the module.

For wiring precautions, see "Input/Output Wiring" on page 3-18.

For the connector cable, see "Cables" on page A-14.

Transistor sink output type: FC6A-D32K3CEE, FC6A-D32K4CEE

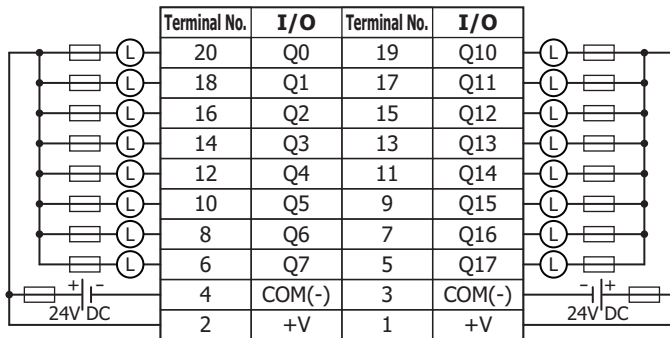

Insert a fuse that corresponds to the load.

Transistor Protection Source Output Type: FC6A-D32P3CEE, FC6A-D32P4CEE

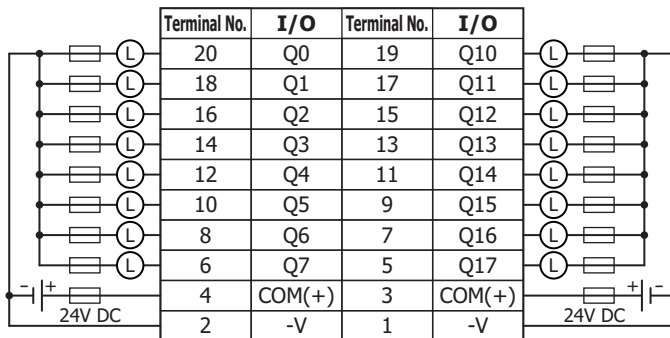

Insert a fuse that corresponds to the load.

2: PRODUCT SPECIFICATIONS

Other Inputs and Ports

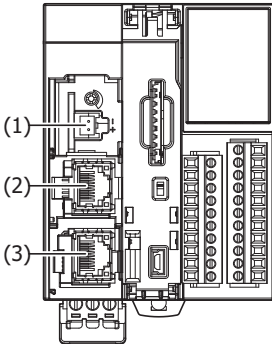

(1) Analog input

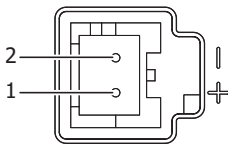

No.	Signal Wire	Cable Color
1	AN(+)	Red
2	AN(-)	Black

(2) Ethernet Port 1

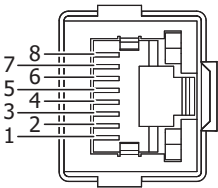

No.	Signal Wire
1	TPO+
2	TPO-
3	TPI+
4	—
5	—
6	TPI-
7	—
8	—
Shell*1	Shield

*1 Shell is connected to FE on the power supply terminals.

(3) Ethernet Port 2

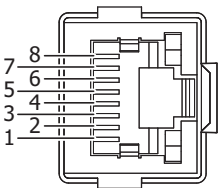

No.	Signal Wire
1	TPO+
2	TPO-
3	TPI+
4	—
5	—
6	TPI-
7	—
8	—
Shell*1	Shield

*1 Shell is connected to FE on the power supply terminals.

Digital I/O Modules

Digital I/O modules are available as three types of modules: digital input modules equipped with input terminals, digital output modules equipped with output terminals, and digital mixed I/O modules equipped with both input and output terminals.

Digital Input Module

Parts Description

Example: FC6A-N08B1

Example: FC6A-N32B3

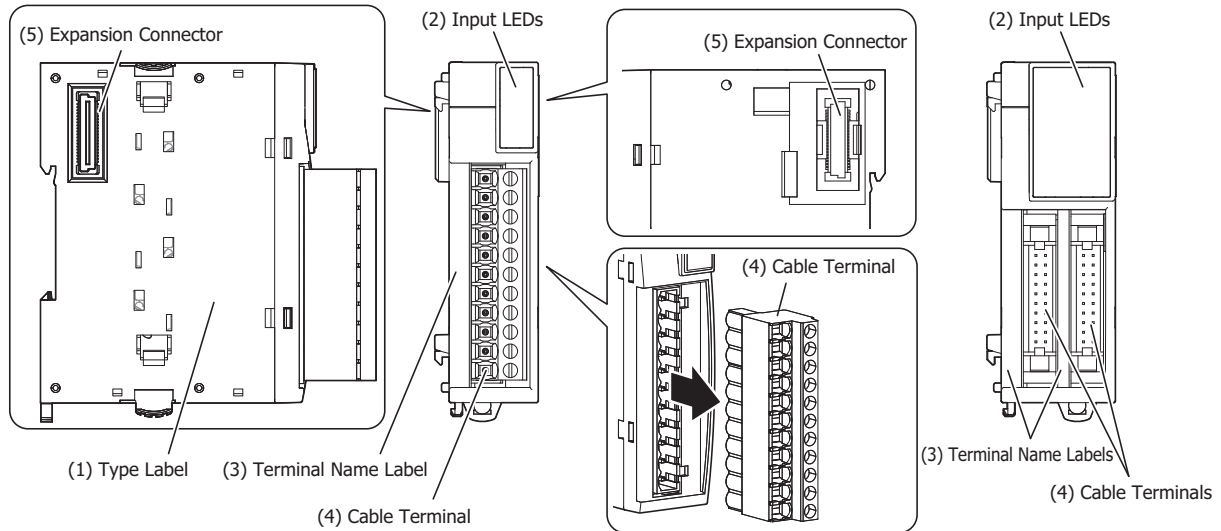

(1) Type Label

Indicates the digital input module type number and specifications.

(2) Input LEDs

These LEDs turn on when an input is on.

(3) Terminal Name Label

Indicates terminal numbers.

(4) Cable Terminal

Three types of terminals are separately available: the terminal block type (3.81 mm pitch), the terminal block type (5.08 mm pitch), and the connector type.

(5) Expansion Connector

Connects the expansion modules and the CPU module.

Model List

■ DC Input Modules

Cable Terminal Type		DC Input 8 Points	DC Input 16 Points	DC Input 32 Points
Terminal block type (5.08 mm pitch)	Screw fastened type	FC6A-N08B1	—	—
	Push-in type	FC6A-N08B4		
Terminal block type (3.81 mm pitch)	Screw fastened type	—	FC6A-N16B1	—
	Push-in type		FC6A-B16B4	
Connector type		—	FC6A-N16B3	FC6A-N32B3

■ AC Input Modules

Cable Terminal Type		AC Input 8 Points
Terminal block type (5.08 mm pitch)	Screw fastened type	FC6A-N08A11
	Push-in type	FC6A-N08A14

2: PRODUCT SPECIFICATIONS

Function Specifications

■ DC Input Module Specifications

Type No.	FC6A-N08B1 FC6A-N08B4	FC6A-N16B1 FC6A-N16B4	FC6A-N16B3	FC6A-N32B3
Rated Input Voltage	12/24V DC* ¹ shared sink/source			
Operating Load Voltage Range	0.0 to 28.8V DC			
Rated Input Current	3.5 mA/point (at 12V DC), 7 mA/point (at 24V DC)		2.5 mA/point (at 12V DC), 5 mA/point (at 24V DC)	
Input Points	8 (8 points in 1 common line)	16 (16 points in 1 common line)		32 (16 points in 1 common line)
Terminal Arrangement	See 2-74	See 2-75	See 2-77	See 2-78
Input Impedance	3.4 kΩ		4.4 kΩ	
Input Delay Time (24V DC)	Turn ON Time	4.1 ms		
	Turn OFF Time	4.1 ms		
Isolation	Between Channels	Not isolated		
	Internal Circuit	Photocoupler isolated		
External Load for I/O Interconnection	Not needed			
Signal Determination Method	Static			
Effect of Improper Input Connection	Even if wiring for sink or source connection is incorrect, no damages are caused. If any input exceeding the rated value is applied, permanent damage may be caused.			
Cable Length	3 m			
Connector	Insertion/Removal Durability 100 times minimum			
Internal Current Draw	All Points ON	30 mA (5V DC) 0 mA (24V DC)	40 mA (5V DC) 0 mA (24V DC)	65 mA (5V DC) 0 mA (24V DC)
	All Points OFF	17 mA (5V DC) 0 mA (24V DC)		
Weight (approx.)	FC6A-N08B1: 110 g FC6A-N08B4: 95 g	FC6A-N16B1: 105 g FC6A-N16B4: 95 g	75 g	110 g

*1 24V DC for products with a version number lower than V400. For details on the version number of modules, see "Checking the Version Number" on page 2-1.

Operating Ranges

The operating range of Type 1 (IEC 61131-2) DC input modules is as follows.

FC6A-N08B1, FC6A-N08B4, FC6A-N16B1, FC6A-N16B4 FC6A-N16B3, FC6A-N32B3

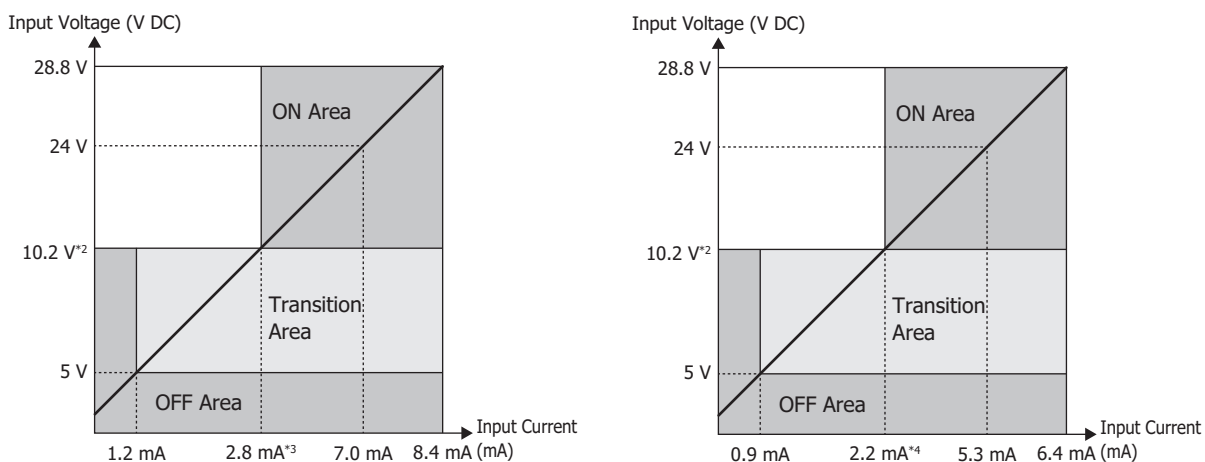

*2 15 V for products with a version number lower than V400. For details on the version number of modules, see "Checking the Version Number" on page 2-1.

*3 4.2 mA for products with a version number lower than V400. For details on the version number of modules, see "Checking the Version Number" on page 2-1.

*4 3.2 mA for products with a version number lower than V400. For details on the version number of modules, see "Checking the Version Number" on page 2-1.

Input Internal Circuit

FC6A-N08B1, FC6A-N08B4, FC6A-N16B1, FC6A-N16B4

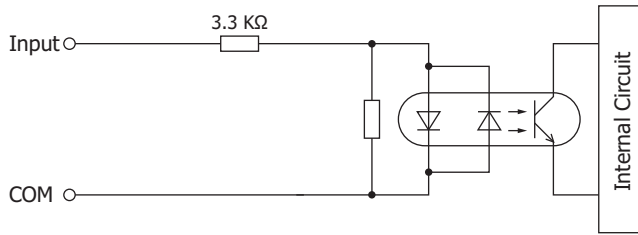

FC6A-N16B3, FC6A-N32B3

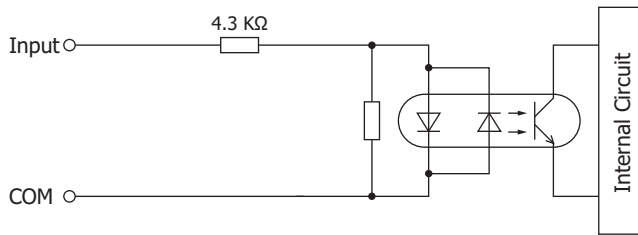

Ambient Temperature, Input Voltage, Output Voltage, I/O Simultaneous ON Ratio

When the FC6A Series MICROSmart is used in an ambient temperature of 30°C or higher, reduce the input voltage and I/O utilization (simultaneous ON ratio: a%) according to the following diagrams. However, the following diagrams show the temperature conditions when the FC6A Series MICROSmart is normally installed.

Note: Normally installed means the state in the diagram in "Normal Installation State" on page 3-1.

The usage conditions will also change according to the installation state. For details, see "Installation Location" on page 3-1.

FC6A-N08B1, FC6A-N08B4

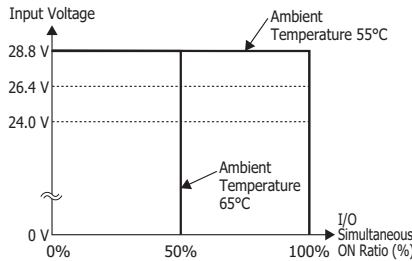

FC6A-N16B1, FC6A-N16B4

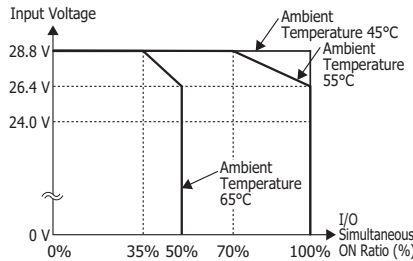

FC6A-N16B3, FC6A-N32B3

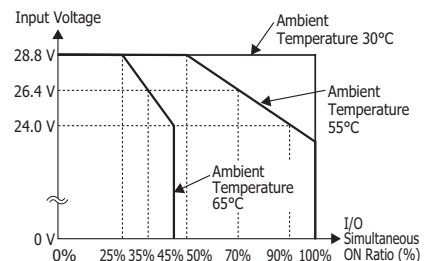

I/O Simultaneous ON Ratio (a%)

FC6A-N08B1, FC6A-N08B4	I0 to I7	There are no usage restrictions for input and output I/O.
FC6A-N16B1, FC6A-N16B4	I0 to I7 I10 to I17	Set the usage ratio of the inputs (ON status) to a% or lower according to the conditions in the above graph.
FC6A-N16B3	I0 to I7 I10 to I17	Set the usage ratio of the inputs (ON status) to a% or lower according to the conditions in the above graph.
FC6A-N32B3	CN1 I0 to I7 I10 to I17	Set the usage ratio of the inputs (ON status) to a% or lower according to the conditions in the above graph.*1
	CN2 I20 to I27 I30 to I37	Set the usage ratio of the inputs (ON status) to a% or lower according to the conditions in the above graph.*1

*1 For the usage ratio of connector CN1 and CN2 inputs, set each to a% or lower.

2: PRODUCT SPECIFICATIONS

■ AC Input Module Specifications

Type No.	FC6A-N08A11, FC6A-N08A14	
Rated Input Voltage	100 to 120V AC	
Operating Load Voltage Range	0 to 132V AC	
Rated Power Frequency	50/60 Hz	
Rated Input Current	15 mA/1 point (at 120V AC, 50/60 Hz)	
Input Points	8 points in 2 common lines	
Terminal Arrangement	See 2-79	
Input Type	AC input Type 1, 2 (IEC 61131-2)	
Input Impedance	8.0 kΩ (at 60 Hz)	
Input Delay Time	Turn ON Time	25 ms
	Turn OFF Time	30 ms
Isolation	In the Same Common Channel	Not isolated
	In Different Common Channels	Isolated
	Between Input and Internal Circuit	Photocoupler isolated
External Load for I/O Interconnection	Not needed	
Signal Determination Method	Static	
Effect of Improper Input Connection	If high voltage is applied that exceeds the input voltage range, there is a risk of permanent damage.	
Connector	Insertion/Removal Durability	100 times minimum
Internal Current Draw	All Points ON	40 mA (5V DC) 0 mA (24V DC)
	All Points OFF	17 mA (5V DC) 0 mA (24V DC)
Weight (approx.)	FC6A-N08A11	110 g
	FC6A-N08A14	95 g

Operating Ranges

The operating range of Type 1 and 2 (IEC 61131-2) AC input modules is as follows.

FC6-N08A11, FC6A-N08A14

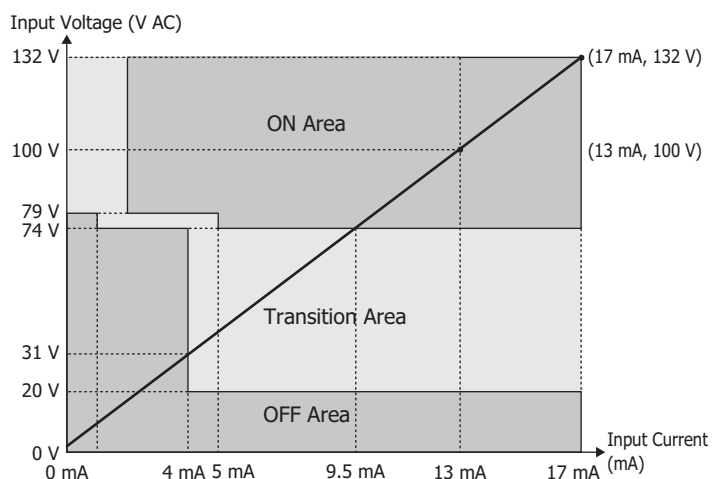

Input Internal Circuit

FC6-N08A11, FC6A-N08A14

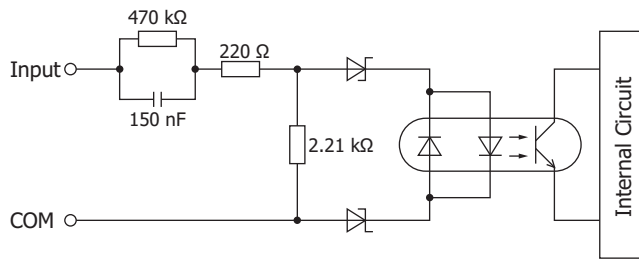

Ambient Temperature, Input Voltage, Output Voltage, I/O Simultaneous ON Ratio

- At conditions where the ambient temperature is 55°C and the input voltage is 132 V, the inputs can be 100% used.
- When the FC6A Series MICROSmart is used in an ambient temperature of 55°C or higher, reduce the input voltage and I/O utilization (simultaneous ON ratio: a%) according to the following diagrams. However, the following diagrams show the temperature conditions when the FC6A Series MICROSmart is normally installed.

Note: Normally installed means the state in the diagram in "Normal Installation State" on page 3-1.

The usage conditions will also change according to the installation state. For details, see "Installation Location" on page 3-1.

FC6-N08A11, FC6A-N08A14

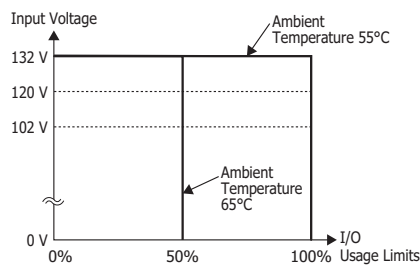

2: PRODUCT SPECIFICATIONS

Terminal Arrangement and Wiring Examples

■ FC6A-N08B1, FC6A-N08B4

Screw fastened type: FC6A-N08B1

Applicable connector: FC6A-PMTB11PN02

Push-in type: FC6A-N08B4

Applicable connector: FC6A-PMSB11PN02

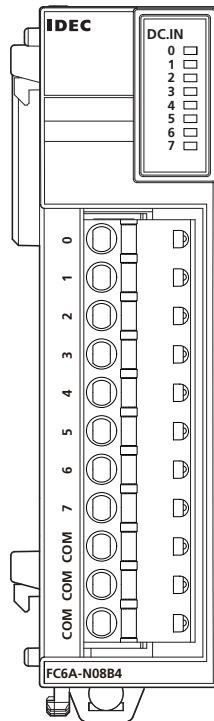
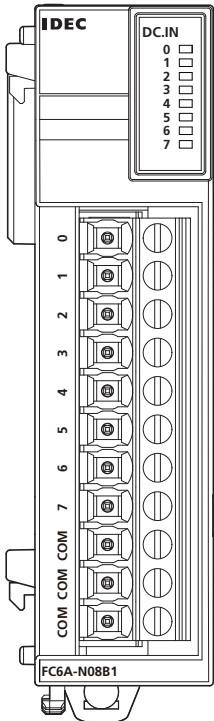

The 3 COM lines are connected in the module.
For wiring precautions, see "Input/Output Wiring" on page 3-18.

DC Sink Input Wiring Example

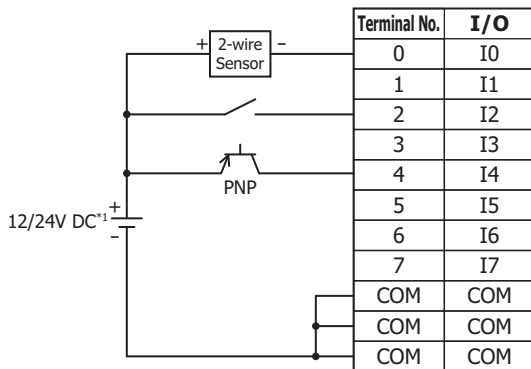

DC Source Input Wiring Example

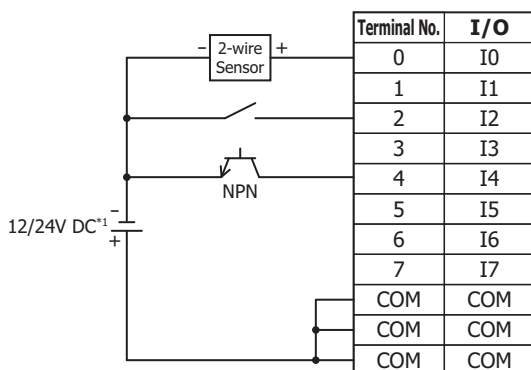

*1 24V DC for products with a version number lower than V400. For details on the version number of modules, see "Checking the Version Number" on page 2-1.

■ FC6A-N16B1, FC6A-N16B4

Screw fastened type: FC6A-N16B1

Applicable connector: FC6A-PMTC10PN02

Push-in type: FC6A-N16B4

Applicable connector: FC6A-PMSC10PN02

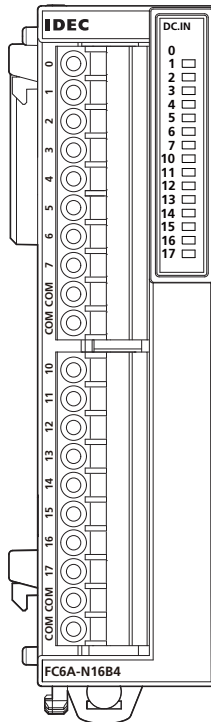
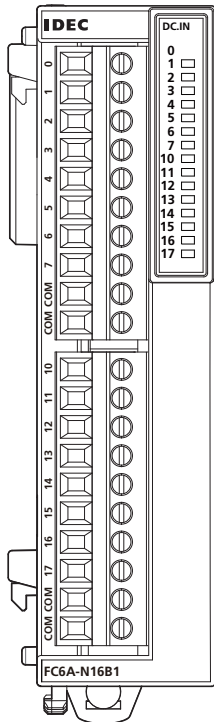

The 4 COM lines are connected in the module.
For wiring precautions, see "Input/Output Wiring" on page 3-18.

DC Sink Input Wiring Example

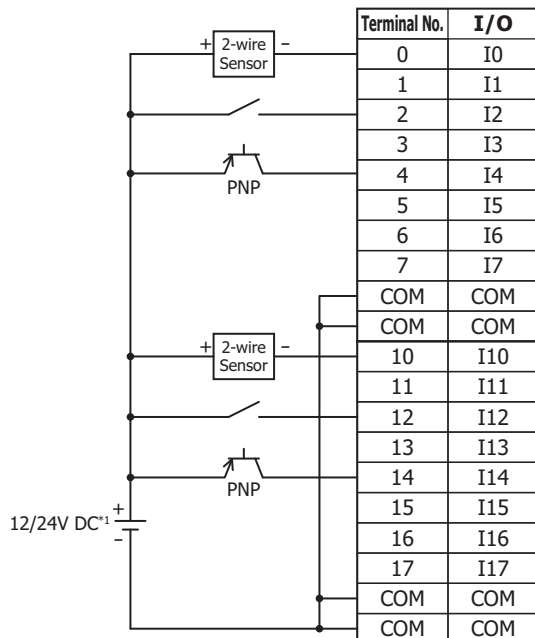

*1 24V DC for products with a version number lower than V400. For details on the version number of modules, see "Checking the Version Number" on page 2-1.

2: PRODUCT SPECIFICATIONS

DC Source Input Wiring Example

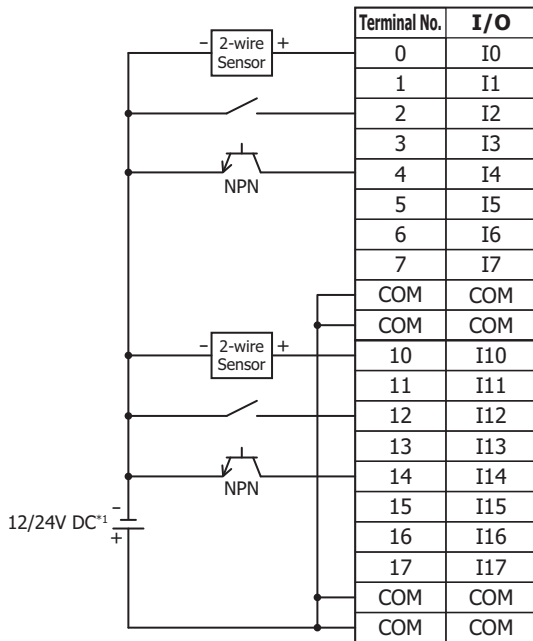

*1 24V DC for products with a version number lower than V400. For details on the version number of modules, see "Checking the Version Number" on page 2-1.

■ FC6A-N16B3

Connector type

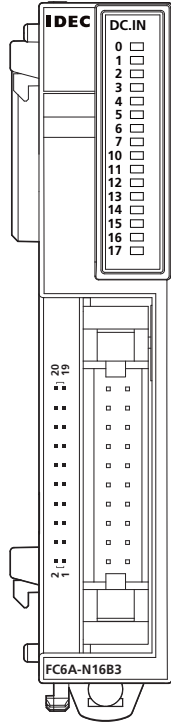

Applicable connector: FC4A-PMC20PNO2

The two COM lines are each connected in the module.

For wiring precautions, see "Input/Output Wiring" on page 3-18. For the connector cable, see "Cables" on page A-14.

DC Sink Input Wiring Example

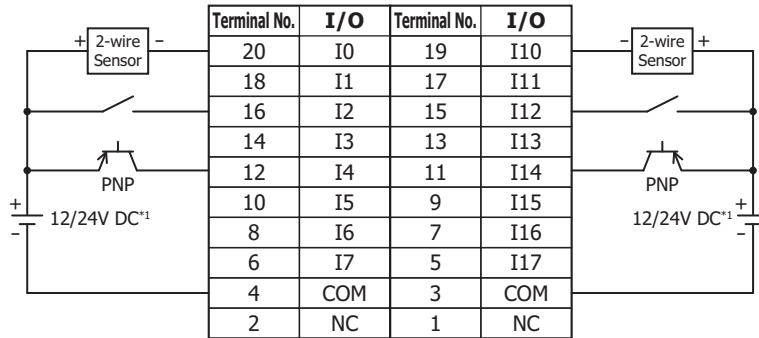

DC Source Input Wiring Example

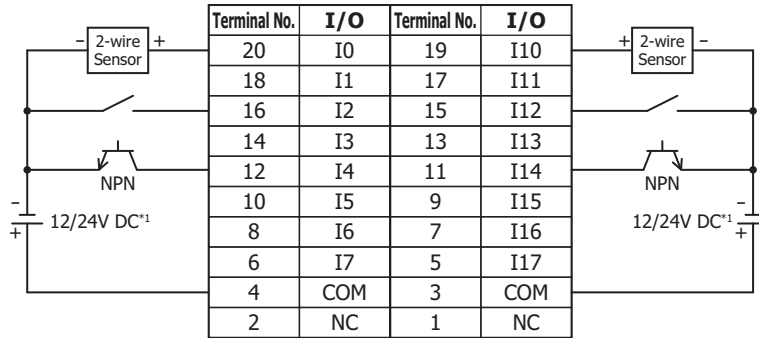

*1 24V DC for products with a version number lower than V400. For details on the version number of modules, see "Checking the Version Number" on page 2-1.

2: PRODUCT SPECIFICATIONS

■ FC6A-N32B3

Connector type

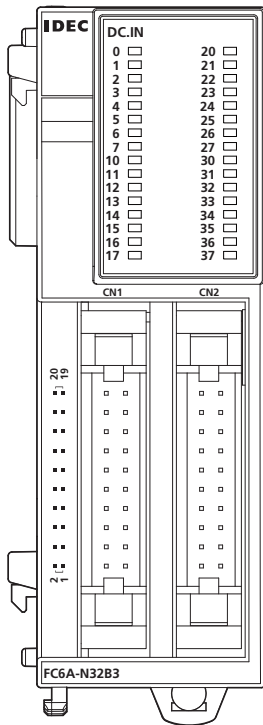

Applicable connector: FC4A-PMC20PNO2

The two COM0 and COM1 lines are each connected in the module.

Each of the terminals for COM0 and COM1 are independent.

For wiring precautions, see "Input/Output Wiring" on page 3-18. For the connector cable, see "Cables" on page A-14.

DC Sink Input Wiring Example

CN1

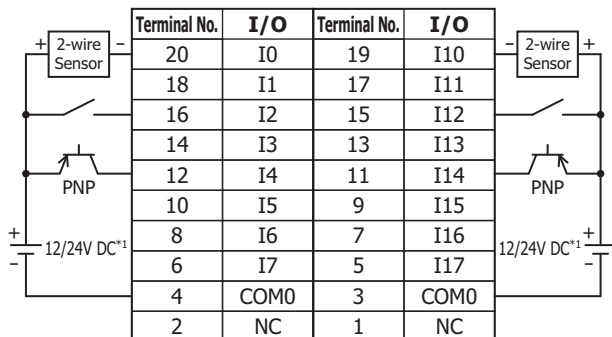

CN2

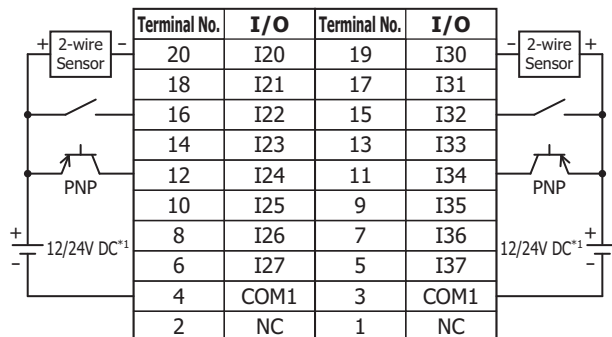

DC Source Input Wiring Example

CN1

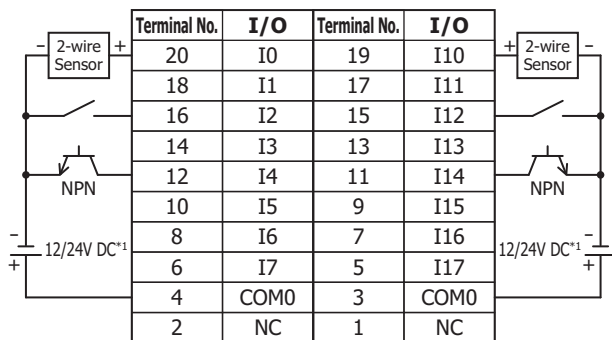

CN2

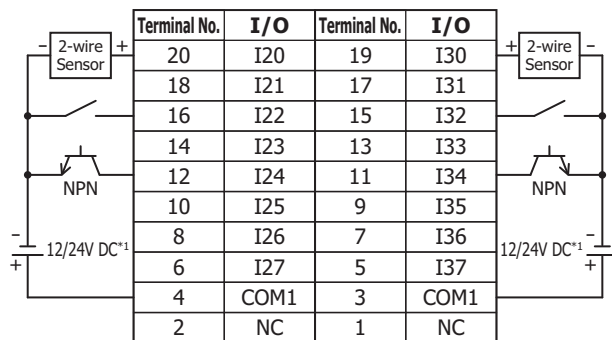

*1 24V DC for products with a version number lower than V400. For details on the version number of modules, see "Checking the Version Number" on page 2-1.

■ FC6A-N08A11, FC6A-N08A14

Screw fastened type: FC6A-N08A11
 Applicable connector: FC6A-PMTB11PN02

Push-in type: FC6A-N08A14
 Applicable connector: FC6A-PMSB11PN02

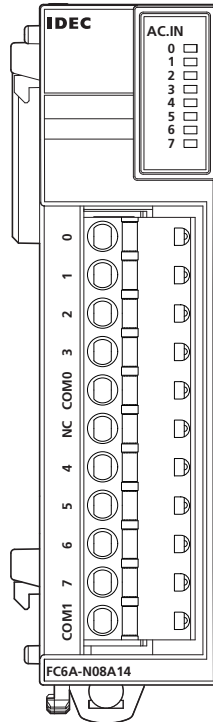
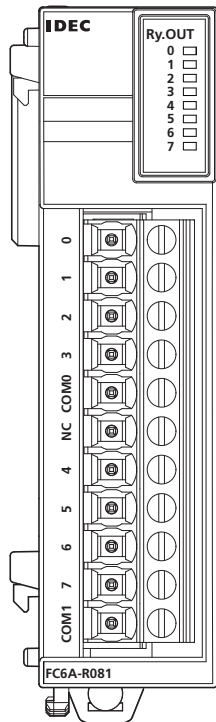

Each of the terminals for COM0 and COM1 are independent.
 For wiring precautions, see "Input/Output Wiring" on page 3-18.

AC input wiring example

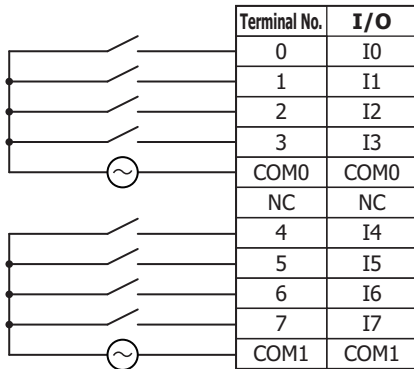

 **Caution** Do not connect an external load.

Digital Output Module

Parts Description

Example: FC6A-R081

Example: FC6A-T32K3

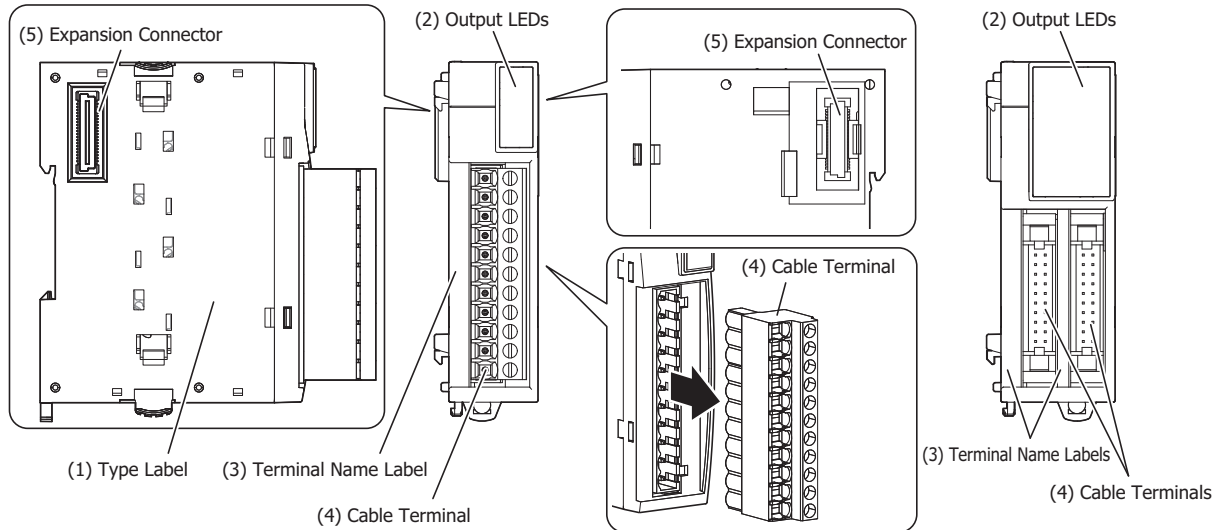

(1) Type Label

Indicates the digital output module type number and specifications.

(2) Output LEDs

These LEDs turn on when an output is on.

(3) Terminal Name Label

Indicates terminal numbers.

(4) Cable Terminal

Three types of terminals are separately available: the terminal block type (3.81 mm pitch), the terminal block type (5.08 mm pitch), and the connector type.

(5) Expansion Connector

Connects the expansion modules and the CPU module.

Model List

■ **Relay Output Modules**

Cable Terminal Type		Relay Output 8 Points	Relay Output 16 Points
Terminal block type (5.08 mm pitch)	Screw fastened type	FC6A-R081	—
	Push-in type	FC6A-R084	
Terminal block type (3.81 mm pitch)	Screw fastened type	—	FC6A-R161
	Push-in type		FC6A-R164

■ **Transistor Sink Output Modules**

Cable Terminal Type		Tr Sink Output 8 Points	Tr Sink Output 16 Points	Tr Sink Output 32 Points
Terminal block type (5.08 mm pitch)	Screw fastened type	FC6A-T08K1	—	—
	Push-in type	FC6A-T08K4		
Terminal block type (3.81 mm pitch)	Screw fastened type	—	FC6A-T16K1	—
	Push-in type		FC6A-T16K4	
Connector type		—	FC6A-T16K3	FC6A-T32K3

■ **Transistor Source Output Modules**

Cable Terminal Type		Tr Source Output 8 Points	Tr Source Output 16 Points	Tr Source Output 32 Points
Terminal block type (5.08 mm pitch)	Screw fastened type	FC6A-T08P1	—	—
	Push-in type	FC6A-T08P4		
Terminal block type (3.81 mm pitch)	Screw fastened type	—	FC6A-T16P1	—
	Push-in type		FC6A-T16P4	
Connector type		—	FC6A-T16P3	FC6A-T32P3

2: PRODUCT SPECIFICATIONS

Function Specifications

■ Relay Output Module Specifications

Type No.	FC6A-R081, FC6A-R084		FC6A-R161, FC6A-R164	
No. of Outputs	8 (4 points in 1 common line)		16 (8 points in 1 common line)	
Output Type	1a contact			
Terminal Arrangement	See 2-88		See 2-89	
Load Current	1	2 A maximum		8 A maximum
	1 Common	7 A maximum		
Minimum Switching Load	1.0 mA/5.0V DC (reference value)			
Initial Contact Resistance	30 mΩ or lower			
Electrical Life	100,000 operations minimum (rated load 1,800 operations/hour)			
Mechanical Life	20,000,000 operations minimum (no load 18,000 operations/hour)			
Rated Load	240V AC 2 A (resistive load, $\cos\phi=0.4$ inductive load)			
	30V DC 2 A (resistive load, L/R=7 ms inductive load)			
Withstand Voltage	Between Output Terminal and FE	2,300V AC 1 minute		
	Between Output Terminal and Internal Circuit	2,300V AC 1 minute		
	Between Output Terminals (COMs)	2,300V AC 1 minute		
Connector	Insertion/Removal Durability	100 times minimum	100 times minimum	
Module Internal Current Draw	All Points ON	35 mA (5V DC) 50 mA (24V DC)	50 mA (5V DC) 100 mA (24V DC)	
	All Points OFF	17 mA (5V DC) 0 mA (24V DC)	17 mA (5V DC) 0 mA (24V DC)	
Weight (approx.)	FC6A-R081: 130 g FC6A-R084: 115 g		FC6A-R161: 140 g FC6A-R164: 130 g	

Note: When expanding the CPU module with relay output modules, there are limitations on the number of relays that can be simultaneously on. For details, see "Connection Restrictions When Expanding the PLC" on page 3-37.

If the maximum number of relays is exceeded, it may not be possible to turn on output relays.

Output Delay

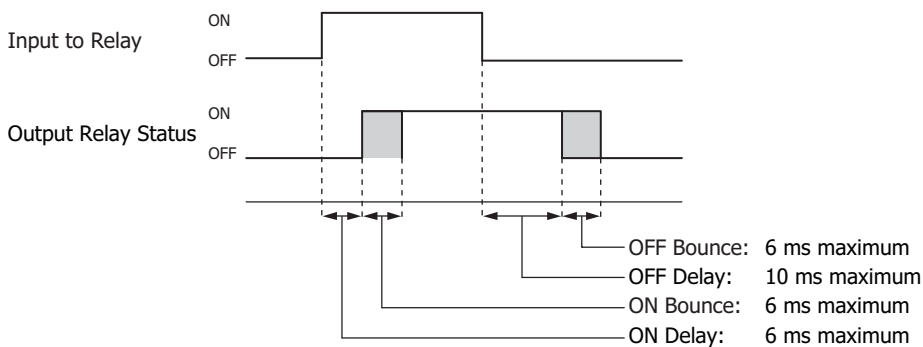

Ambient Temperature, Input Voltage, Output Voltage, I/O Simultaneous ON Ratio

When the FC6A Series MICROSmart is used in an ambient temperature of 55°C or higher, reduce the output voltage and I/O utilization (simultaneous ON ratio: a%) according to the following diagrams. However, the following diagrams show the temperature conditions when the FC6A Series MICROSmart is normally installed.

Note: Normally installed means the state in the diagram in "Normal Installation State" on page 3-1.

The usage conditions will also change according to the installation state. For details, see "Installation Location" on page 3-1.

FC6A-R081, FC6A-R084, FC6A-R161, FC6A-R164

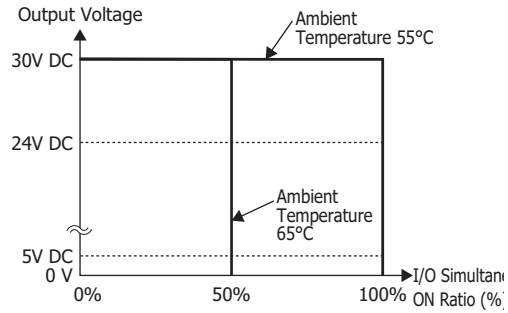
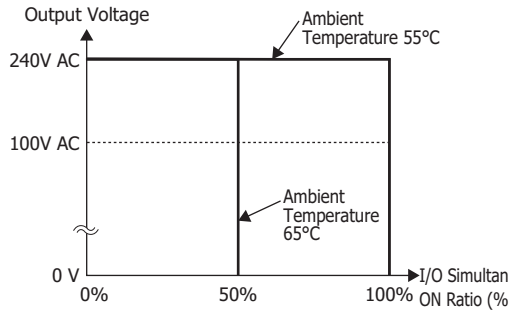

2: PRODUCT SPECIFICATIONS

■ Transistor Sink Output Module Specifications

Type No.	FC6A-T08K1 FC6A-T08K4	FC6A-T16K1 FC6A-T16K4	FC6A-T16K3	FC6A-T32K3
Output Signal	Transistor sink output			
Rated Load Voltage	12/24V DC*1			
Operating Load Voltage Range	10.2 to 28.8V DC			
No. of Outputs	8 (8 points in 1 common line)	16 (16 points in 1 common line)		32 (16 points in 1 common line)
Rated Load	0.5 A 1 point		0.1 A 1 point	
Terminal Arrangement	See 2-90	See 2-92	See 2-94	See 2-95
Voltage Drop (ON Voltage)	0.4 V or less, voltage between COM and output terminal when ON			
Allowed Inrush Current	1 A maximum			
Leakage Current	0.1 mA maximum			
Clamping Voltage	50 V			
Lamp Load	12 W maximum		2.4 W maximum	
Inductive Load	L/R = 10 ms (28.8V DC, 1 Hz)			
External Current Draw	100 mA maximum, 24V DC (+V terminal supply power)			
Isolation	Between Output Terminal and Internal Circuit	Photocoupler isolated		
	Between Output Terminals	Not isolated		
Connector	Insertion/Removal Durability	100 times minimum		
Internal Current Draw	All Points ON	25 mA (5V DC) 15 mA (24V DC)	30 mA (5V DC) 25 mA (24V DC)	45 mA (5V DC) 50 mA (24V DC)
	All Points OFF	17 mA (5V DC) 0 mA (24V DC)		
Output Delay	Turn ON Time	450 μs or lower		
	Turn OFF Time	450 μs or lower		
Weight (approx.)	FC6A-T08K1: 110 g FC6A-T08K4: 95 g	FC6A-T16K1: 105 g FC6A-T16K4: 95 g	70 g	115 g

*1 24V DC for products with a version number lower than V400. For details on the version number of modules, see "Checking the Version Number" on page 2-1.

Output Internal Circuit

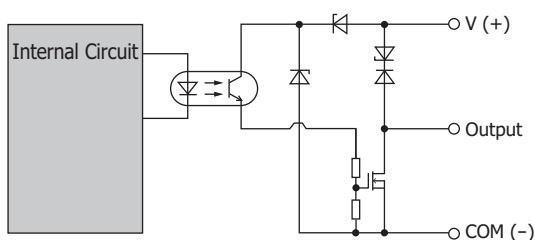

Ambient Temperature, Input Voltage, Output Voltage, I/O Simultaneous ON Ratio

When the FC6A Series MICROSmart is used in an ambient temperature of 55°C or higher, reduce the output voltage and I/O utilization (simultaneous ON ratio: a%) according to the following diagrams. However, the following diagrams show the temperature conditions when the FC6A Series MICROSmart is normally installed.

Note: Normally installed means the state in the diagram in "Normal Installation State" on page 3-1.

The usage conditions will also change according to the installation state. For details, see "Installation Location" on page 3-1.

FC6A-T08K1, FC6A-T08K4, FC6A-T16K1, FC6A-T16K4, FC6A-T16K3, FC6A-T32K3

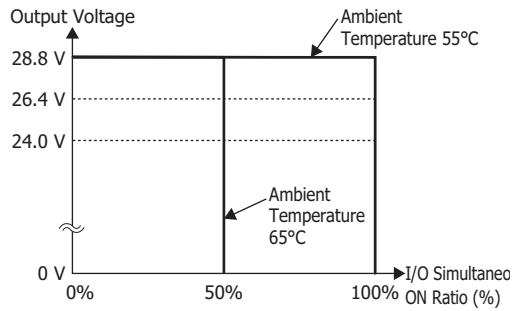

2: PRODUCT SPECIFICATIONS

■ Transistor Protection Source Output Module Specifications

Type No.	FC6A-T08P1 FC6A-T08P4	FC6A-T16P1 FC6A-T16P4	FC6A-T16P3	FC6A-T32P3
Output Signal	Transistor protection source output			
Rated Load Voltage	24V DC			
Operating Load Voltage Range	20.4 to 28.8V DC			
No. of Outputs	8 (8 points in 1 common line)	16 (16 points in 1 common line)		32 (16 points in 1 common line)
Rated Load	0.5 A 1 point		0.1 A 1 point	
Terminal Arrangement	See 2-91	See 2-93	See 2-94	See 2-96
Output Current Limit Range	1.01 to 2.6 A		0.7 to 1.7 A	
Voltage Drop (ON Voltage)	0.4 V or less, voltage between COM and output terminal when ON			
Allowed Inrush Current	1 A maximum			
Leakage Current	0.1 mA maximum			
Clamping Voltage	41 to 52 V			
Lamp Load	12 W maximum		9.6 W maximum	
Inductive Load	L/R = 10 ms (28.8V DC, 1 Hz)			
Protection Operation	Temporarily protected by element heat generation, automatic recovery. (There is no function that detects the protection error.)			
External Current Draw	100 mA maximum, 24V DC (-V terminal supply power)			
Isolation	Between Output Terminal and Internal Circuit	Photocoupler isolated		
	Between Output Terminals	Not isolated		
Connector	Insertion/Removal Durability	100 times minimum		
Module Internal Current Draw	All points ON	25 mA (5V DC) 15 mA (24V DC)	30 mA (5V DC) 25 mA (24V DC)	45 mA (5V DC) 50 mA (24V DC)
	All points OFF	17 mA (5V DC) 0 mA (24V DC)		
Output Delay	Turn ON Time	450 μs or lower		
	Turn OFF Time	450 μs or lower		
Weight (approx.)	FC6A-T08P1: 110 g FC6A-T08P4: 95 g	FC6A-T16P1: 105 g FC6A-T16P4: 95 g	75 g	115 g

Output Internal Circuit

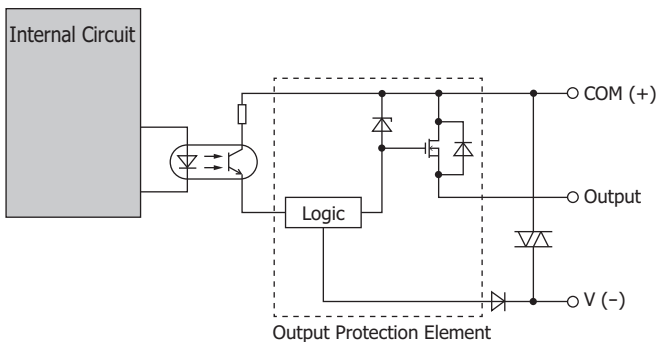

(The overcurrent detection circuit has been omitted.)

Ambient Temperature, Input Voltage, Output Voltage, I/O Simultaneous ON Ratio

When the FC6A Series MICROSmart is used in an ambient temperature of 55°C or higher, reduce the output voltage and I/O utilization (simultaneous ON ratio: a%) according to the following diagrams. However, the following diagrams show the temperature conditions when the FC6A Series MICROSmart is normally installed.

Note: Normally installed means the state in the diagram in "Normal Installation State" on page 3-1.

The usage conditions will also change according to the installation state. For details, see "Installation Location" on page 3-1.

FC6A-T08P1, FC6A-T08P4, FC6A-T16P1, FC6A-T16P4, FC6A-T16P3, FC6A-T32P3

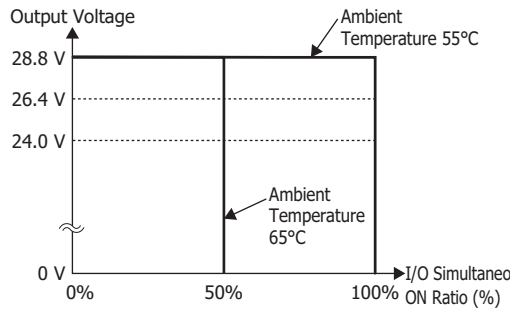

2: PRODUCT SPECIFICATIONS

Terminal Arrangement and Wiring Examples

■ FC6A-R081, FC6A-R084

Screw fastened type: FC6A-R081

Applicable connector: FC6A-PMTB11PN02

Push-in type: FC6A-R084

Applicable connector: FC6A-PMSB11PN02

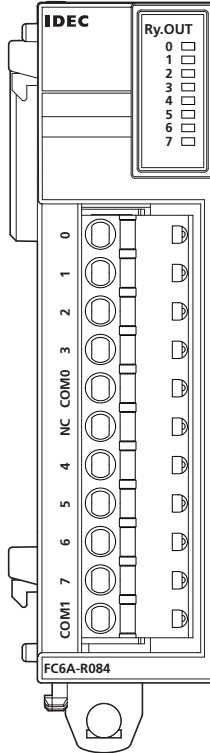
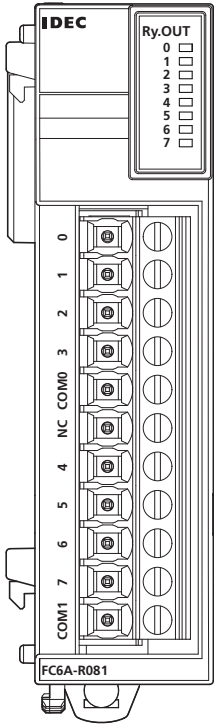

Each of the terminals for COM0 and COM1 are independent.
For wiring precautions, see "Input/Output Wiring" on page 3-18.

— : Fuse (L) : Load

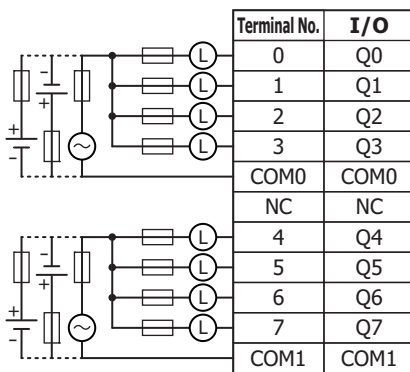

■ FC6A-R161, FC6A-R164

Screw fastened type: FC6A-R161

Applicable connector: FC6A-PMTC10PN02

Push-in type: FC6A-R164

Applicable connector: FC6A-PMSC10PN02

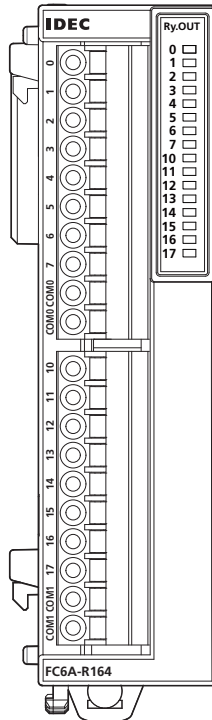
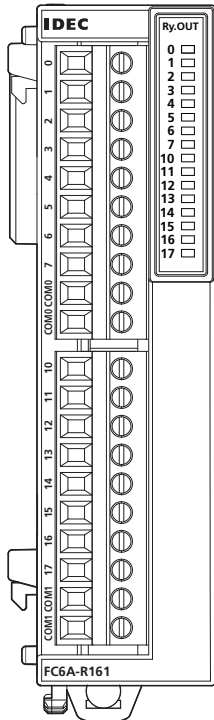

The two COM0 and COM1 lines are each connected in the module.
 Each of the terminals for COM0 and COM1 are independent.
 For wiring precautions, see "Input/Output Wiring" on page 3-18.

—□— : Fuse (L) : Load

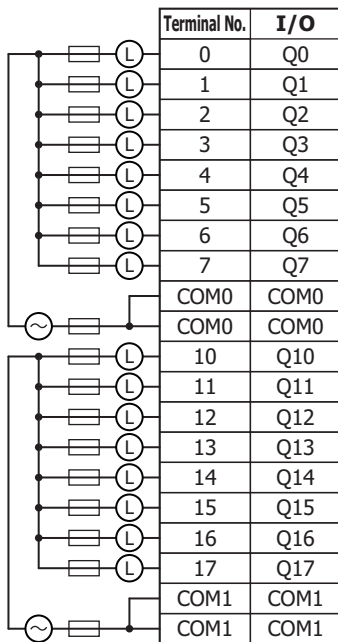

2: PRODUCT SPECIFICATIONS

■ FC6A-T08K1, FC6A-T08K4

Screw fastened type: FC6A-T08K1

Applicable connector: FC6A-PMTB11PN02

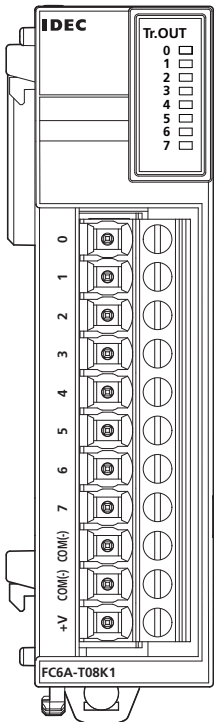

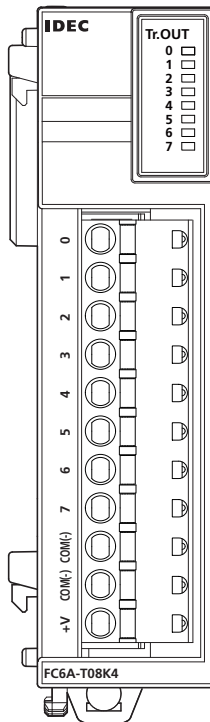

Push-in type: FC6A-T08K4

Applicable connector: FC6A-PMSB11PN02



For wiring precautions, see "Input/Output Wiring" on page 3-18.

 : Fuse  : Load

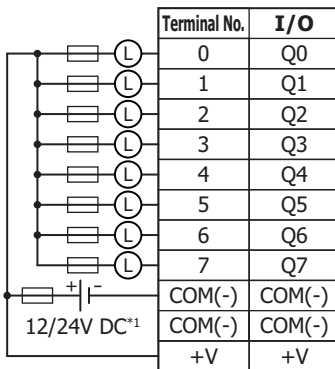

Insert a fuse that corresponds to the load.

*1 24V DC for products with a version number lower than V400. For details on the version number of modules, see "Checking the Version Number" on page 2-1.

■ FC6A-T08P1, FC6A-T08P4

Screw fastened type: FC6A-T08P1

Applicable connector: FC6A-PMTB11PN02

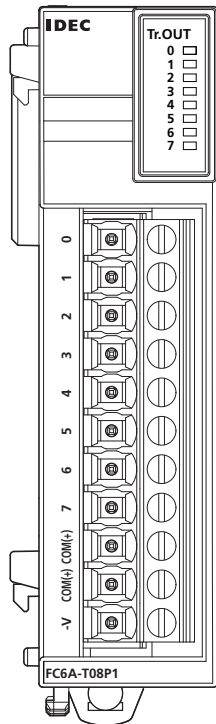

Push-in type: FC6A-T08P4

Applicable connector: FC6A-PMSB11PN02

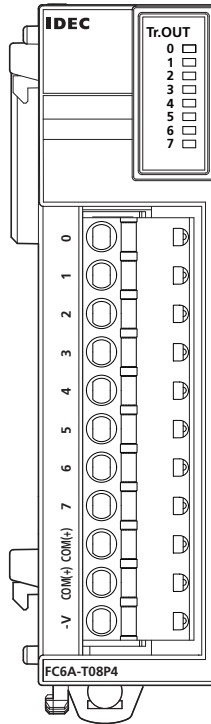

For wiring precautions, see "Input/Output Wiring" on page 3-18.

— : Fuse (L) : Load

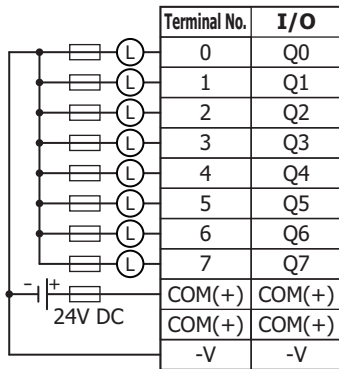

Insert a fuse that corresponds to the load.

2: PRODUCT SPECIFICATIONS

■ FC6A-T16K1, FC6A-T16K4

Screw fastened type: FC6A-T16K1

Applicable connector: FC6A-PMTC10PN02

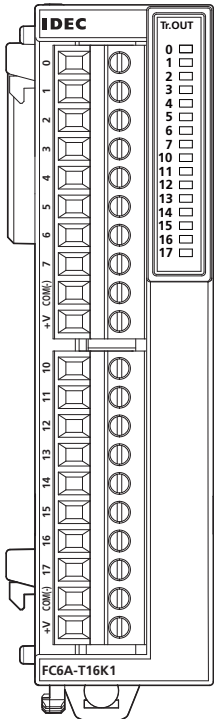

Push-in type: FC6A-T16K4

Applicable connector: FC6A-PMSC10PN02

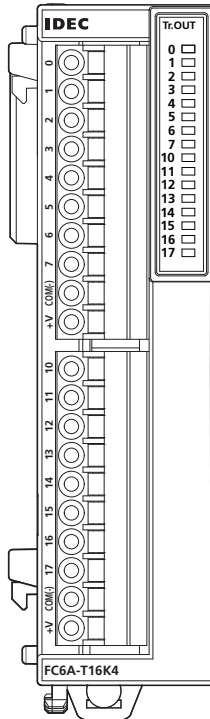

The two COM(-) lines are each connected in the module.
 The two +V lines are each connected in the module.
 For wiring precautions, see "Input/Output Wiring" on page 3-18.

—|— : Fuse (L) : Load

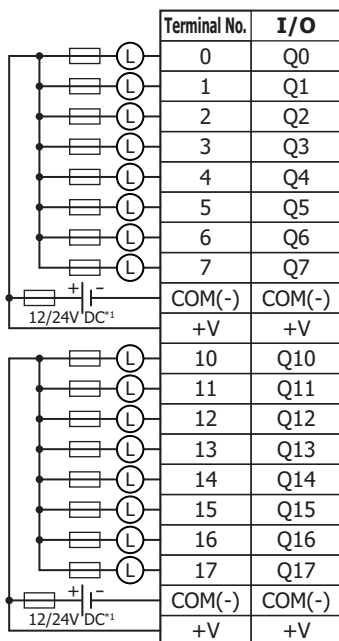

Insert a fuse that corresponds to the load.

*1 24V DC for products with a version number lower than V400. For details on the version number of modules, see "Checking the Version Number" on page 2-1.

■ FC6A-T16P1, FC6A-T16P4

Screw fastened type: FC6A-T16P1

Applicable connector: FC6A-PMTC10PN02

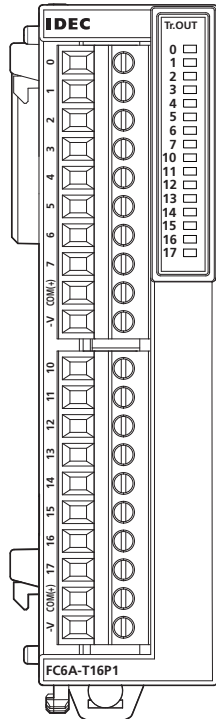

Push-in type: FC6A-T16P4

Applicable connector: FC6A-PMSC10PN02

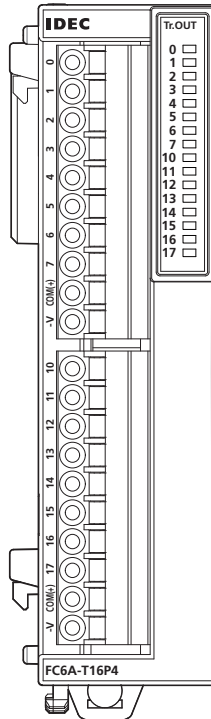

The two COM(+) lines are each connected in the module.
 The two -V lines are each connected in the module.
 For wiring precautions, see "Input/Output Wiring" on page 3-18.

— : Fuse (L) : Load

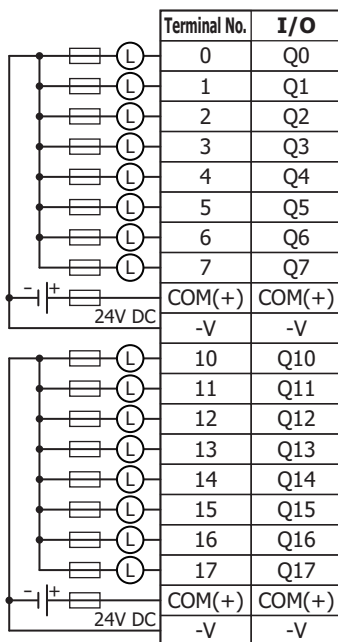

Insert a fuse that corresponds to the load.

2: PRODUCT SPECIFICATIONS

■ FC6A-T16K3, FC6A-T16P3

Terminal block types

Applicable connector: FC4A-PMC20PN02

The two COM(+) and COM(-) lines are each connected in the module.

The two +V and -V lines are each connected in the module.

For wiring precautions, see "Input/Output Wiring" on page 3-18.

For the connector cable, see "Cables" on page A-14.

—|— : Fuse (L) : Load

FC6A-T16K3

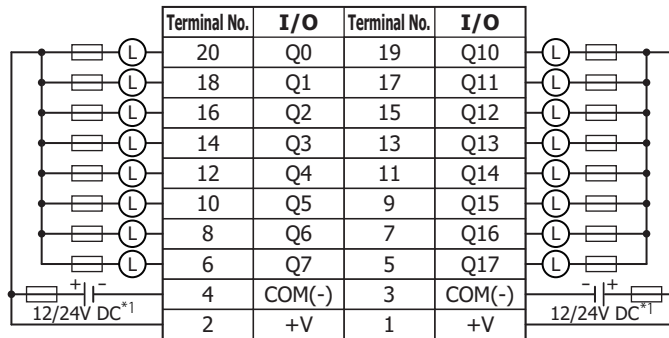
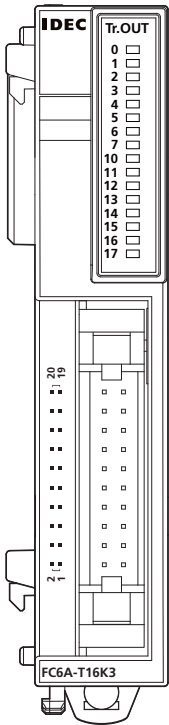

Insert a fuse that corresponds to the load.

*1 24V DC for products with a version number lower than V400. For details on the version number of modules, see "Checking the Version Number" on page 2-1.

FC6A-T16P3

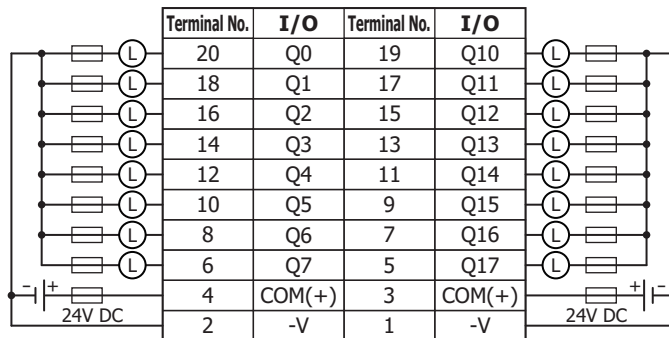
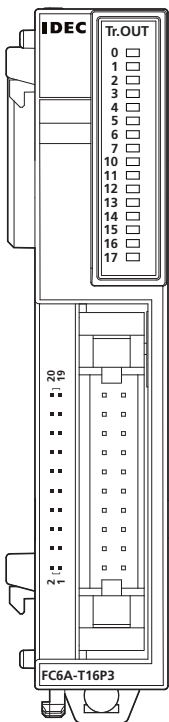

Insert a fuse that corresponds to the load.

■ FC6A-T32K3

Terminal block type

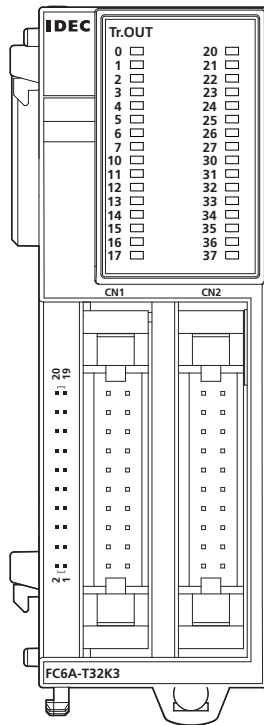

Applicable connector: FC4A-PMC20PN02

The two COM0(-) and COM1(-) lines are each connected in the module.

Each of the terminals for COM0(-) and COM1(-) are independent.

The two +V0 and +V1 lines are each connected in the module.

Each of the terminals for +V0 and +V1 are independent.

For wiring precautions, see "Input/Output Wiring" on page 3-18.

For the connector cable, see "Cables" on page A-14.

— : Fuse (L) : Load

CN1

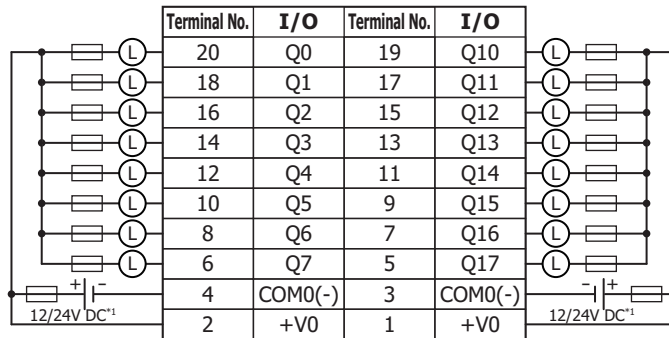

Insert a fuse that corresponds to the load.

CN2

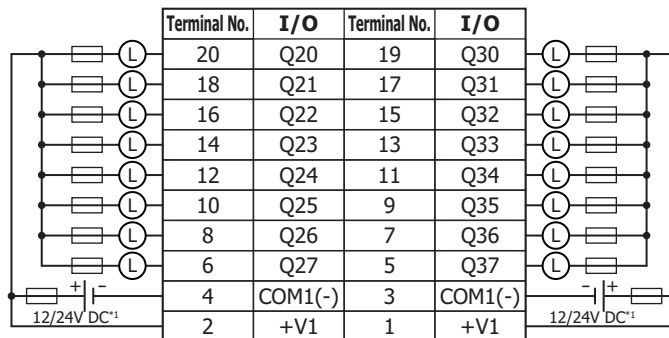

Insert a fuse that corresponds to the load.

*1 24V DC for products with a version number lower than V400. For details on the version number of modules, see "Checking the Version Number" on page 2-1.

2: PRODUCT SPECIFICATIONS

■ FC6A-T32P3

Terminal block type

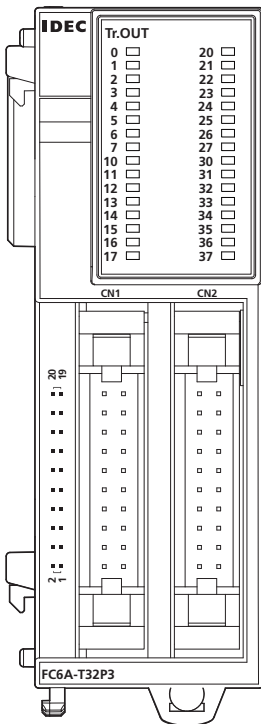

Applicable connector: FC4A-PMC20PN02

The two COM0(+) and COM1(+) lines are each connected in the module.

Each of the terminals for COM0(+) and COM1(+) are independent.

The two -V0 and -V1 lines are each connected in the module.

Each of the terminals for -V0 and -V1 are independent.

For wiring precautions, see "Input/Output Wiring" on page 3-18.

For the connector cable, see "Cables" on page A-14.

— : Fuse (L) : Load

CN1

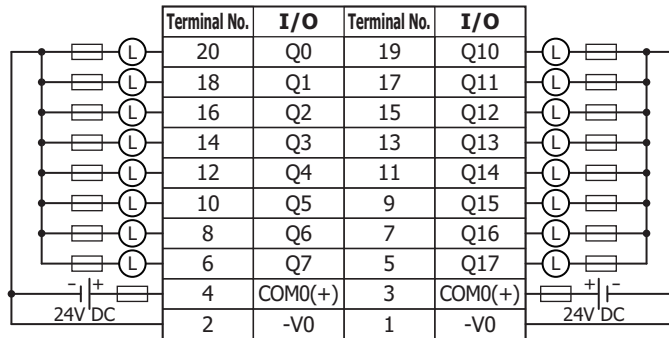

Insert a fuse that corresponds to the load.

CN2

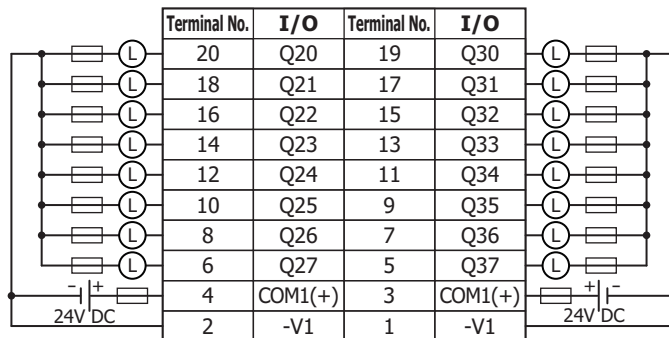

Insert a fuse that corresponds to the load.

Digital Mixed I/O Module

Parts Description

Example: FC6A-M08BR1

Example: FC6A-M24BR1

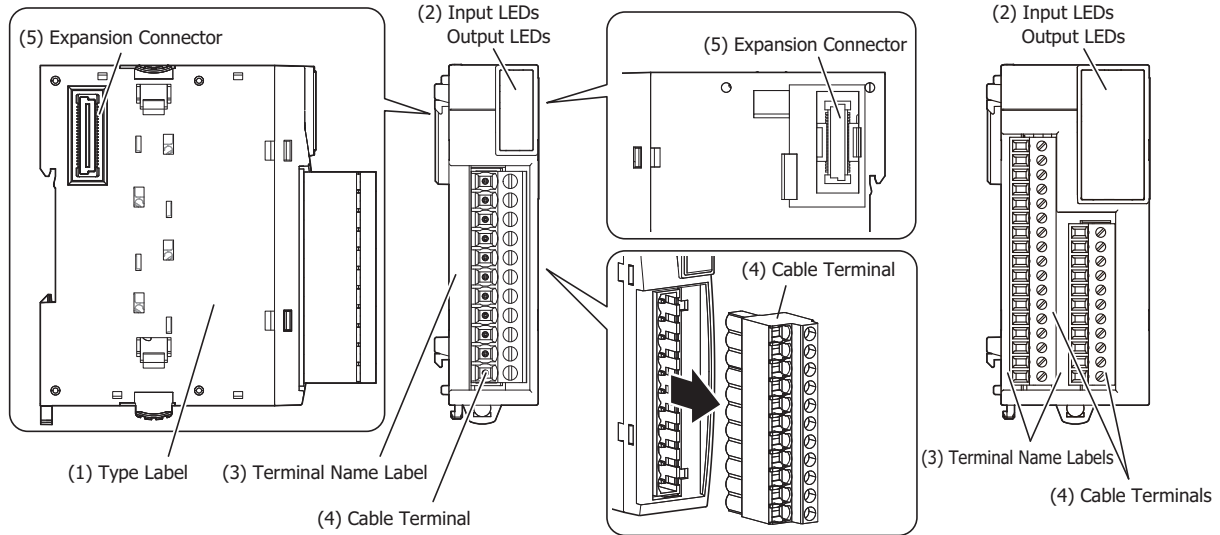

(1) Type Label

Indicates the digital mixed I/O module type number and specifications.

(2) Input LEDs

These LEDs turn on when an input is on.

Output LEDs

These LEDs turn on when an output is on.

(3) Terminal Name Label

Indicates terminal numbers.

(4) Cable Terminal

Two types of terminals are separately available: the terminal block type (3.81 mm pitch) and the terminal block type (5.08 mm pitch).

(5) Expansion Connector

Connects the expansion modules and the CPU module.

Model List

Cable Terminal Type		DC Input 4 Points/ Relay Output 4 Points	DC Input 16 Points/ Relay Output 8 Points
Terminal block type (5.08 mm pitch)	Screw fastened type	FC6A-M08BR1	—
	Push-in type	FC6A-M08BR4	
Terminal block type (3.81 mm pitch)	Screw fastened type	—	FC6A-M24BR1
	Push-in type		FC6A-M24BR4

2: PRODUCT SPECIFICATIONS

Function Specifications

■ Power Supply Specifications

Type No.		FC6A-M08BR1, FC6A-M08BR4	FC6A-M24BR1, FC6A-M24BR4
Points	Input Points	4 (4 points in 1 common line)	16 (16 points in 1 common line)
	No. of Outputs	4 (4 points in 1 common line)	8 (4 points in 1 common line)
Terminal Arrangement		See 2-101	See 2-103
Connector	Insertion/Removal Durability	100 times minimum	
Internal Current Draw	All Points ON	30 mA (5V DC) 25 mA (24V DC)	55 mA (5V DC) 50 mA (24V DC)
	All Points OFF	17 mA (5V DC) 0 mA (24V DC)	
Weight (approx.)		FC6A-M08BR1: 120 g FC6A-M08BR4: 100 g	FC6A-M24BR1: 165 g FC6A-M24BR4: 155 g

■ Input Specifications

Type No.		FC6A-M08BR1, FC6A-M08BR4	FC6A-M24BR1, FC6A-M24BR4
Rated Input Voltage		12/24V DC*1 shared sink/source	
Operating Load Voltage Range		0.0 to 28.8V DC	
Rated Input Current		3.5 mA/point (at 12V DC), 7 mA/point (at 24V DC)	
Input Impedance		3.4 kΩ	
Input Delay Time (24V DC)	Turn ON Time	4.1 ms	
	Turn OFF Time	4.1 ms	
Isolation	Between Channels	Not isolated	
	Internal Circuit	Photocoupler isolated	
External Load for I/O Interconnection		Not needed	
Signal Determination Method		Static	
Effect of Improper Input Connection		Even if wiring for sink or source connection is incorrect, no damages are caused. If any input exceeding the rated value is applied, permanent damage may be caused.	
Cable Length		3 m	

*1 24V DC for products with a version number lower than V400. For details on the version number of modules, see "Checking the Version Number" on page 2-1.

Operating Ranges

The operating range of Type 1 (IEC 61131-2) DC input modules is as follows.

FC6A-M08BR1, FC6A-M08BR4, FC6A-M24BR1, FC6A-M24BR4

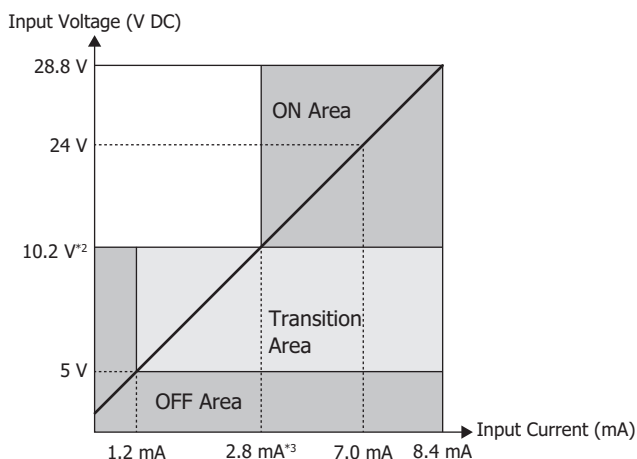

*2 15 V for products with a version number lower than V400. For details on the version number of modules, see "Checking the Version Number" on page 2-1.

*3 4.2 mA for products with a version number lower than V400. For details on the version number of modules, see "Checking the Version Number" on page 2-1.

Input Internal Circuit

FC6A-M08BR1, FC6A-M08BR4, FC6A-M24BR1, FC6A-M24BR4

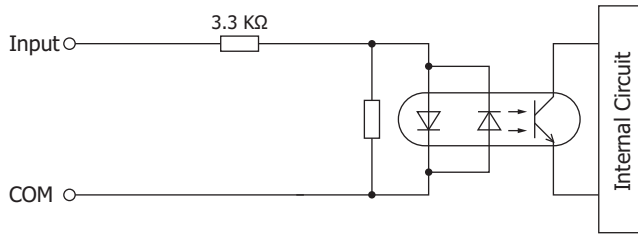

Ambient Temperature, Input Voltage, I/O Simultaneous ON Ratio

When the FC6A Series MICROSmart is used in an ambient temperature of 45°C or higher, reduce the input voltage and I/O utilization (simultaneous ON ratio: a%) according to the following diagrams. However, the following diagrams show the temperature conditions when the FC6A Series MICROSmart is normally installed.

Note: Normally installed means the state in the diagram in "Normal Installation State" on page 3-1.

The usage conditions will also change according to the installation state. For details, see "Installation Location" on page 3-1.

FC6A-M08BR1, FC6A-M08BR4

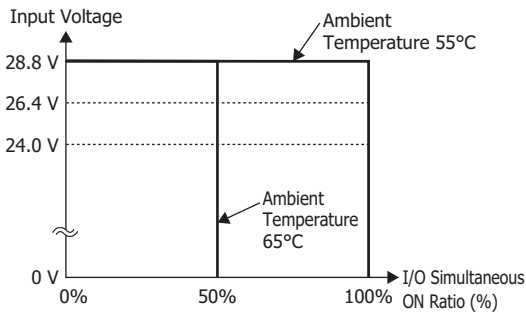

FC6A-M24BR1, FC6A-M24BR4

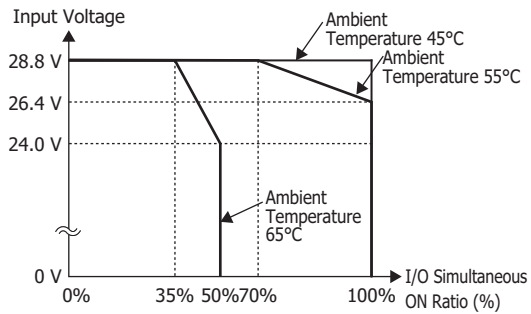

2: PRODUCT SPECIFICATIONS

■ Output Specifications

Type No.		FC6A-M08BR1, FC6A-M08BR4	FC6A-M24BR1, FC6A-M24BR4
Output Points per Common Line	COM1	4	4
	COM2	—	4
Output Type		1a contact	
Load Current	1	2 A maximum	
	1 Common	7 A maximum	
Minimum Switching Load		1.0 mA/5.0V DC (reference value)	
Initial Contact Resistance		30 mΩ or lower	
Electrical Life		100,000 operations minimum (rated load 1,800 operations/hour)	
Mechanical Life		20,000,000 operations minimum (no load 18,000 operations/hour)	
Rated Load		240V AC 2 A (resistive load, $\cos\phi=0.4$ inductive load)	
		30V DC 2 A (resistive load, L/R=7 ms inductive load)	
Withstand Voltage	Between Output Terminal and FE	2,300V AC 1 minute	
	Between Output Terminal and Internal Circuit	2,300V AC 1 minute	
	Between Output Terminals (COMs)	2,300V AC 1 minute	

Output Delay

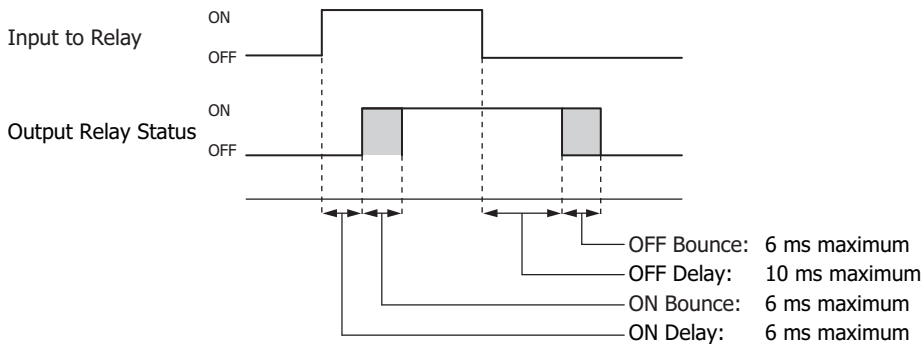

Ambient Temperature, Input Voltage, I/O Simultaneous ON Ratio

When the FC6A Series MICROSmart is used in an ambient temperature of 55°C or higher, reduce the output voltage and I/O utilization (simultaneous ON ratio: a%) according to the following diagrams. However, the following diagrams show the temperature conditions when the FC6A Series MICROSmart is normally installed.

Note: Normally installed means the state in the diagram in "Normal Installation State" on page 3-1.

The usage conditions will also change according to the installation state. For details, see "Installation Location" on page 3-1.

FC6A-M08BR1, FC6A-M08BR4, FC6A-M24BR1, FC6A-M24BR4

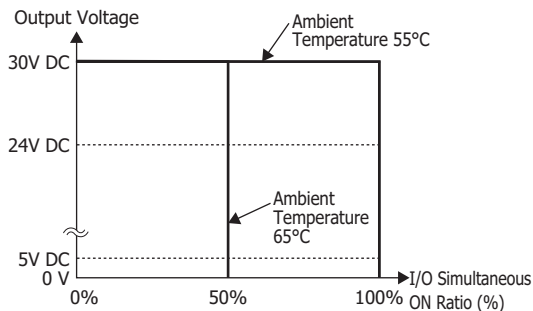
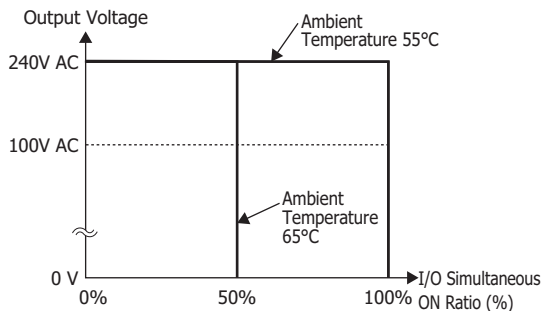

Terminal Arrangement and Wiring Examples

■ **FC6A-M08BR1, FC6A-M08BR4**

Screw fastened type: FC6A-M08BR1
Applicable connector: FC6A-PMTB11PN02

Push-in type: FC6A-M08BR4
Applicable connector: FC6A-PMSB11PN02

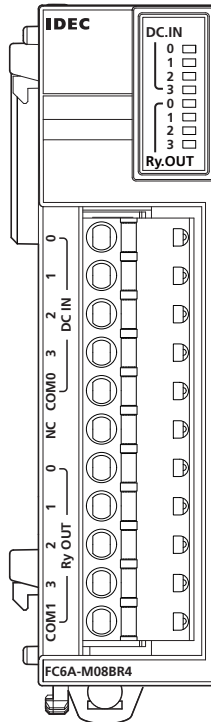
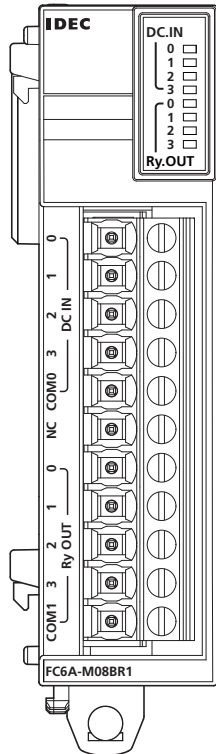

Each of the terminals for COM0 and COM1 are independent.
For wiring precautions, see "Input/Output Wiring" on page 3-18.

—|— : Fuse (L) : Load

DC Sink Input Wiring Example

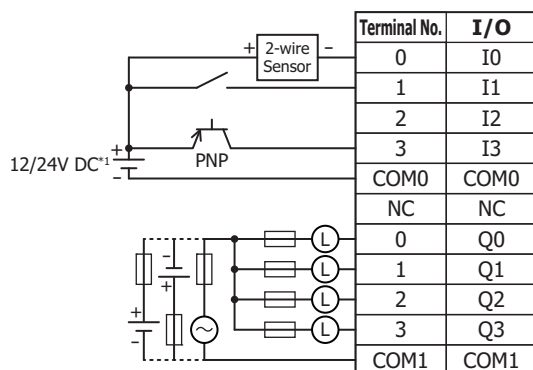

*1 24V DC for products with a version number lower than V400. For details on the version number of modules, see "Checking the Version Number" on page 2-1.

2: PRODUCT SPECIFICATIONS

DC Source Input Wiring Example

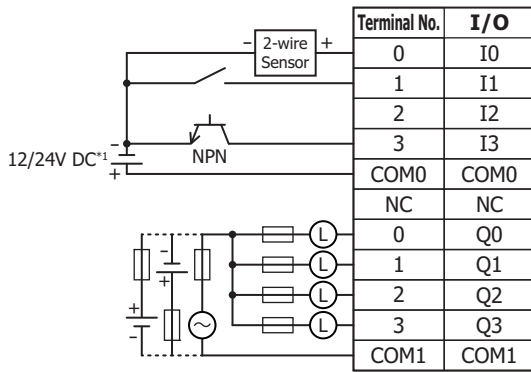

*1 24V DC for products with a version number lower than V400. For details on the version number of modules, see "Checking the Version Number" on page 2-1.

■ FC6A-M24BR1, FC6A-M24BR4

Screw fastened type: FC6A-M24BR1

Applicable connector: FC6A-PMTC17PN02
FC6A-PMTC11PN02

Push-in type: FC6A-M24BR4

Applicable connector: FC6A-PMSC17PN02
FC6A-PMSC11PN02

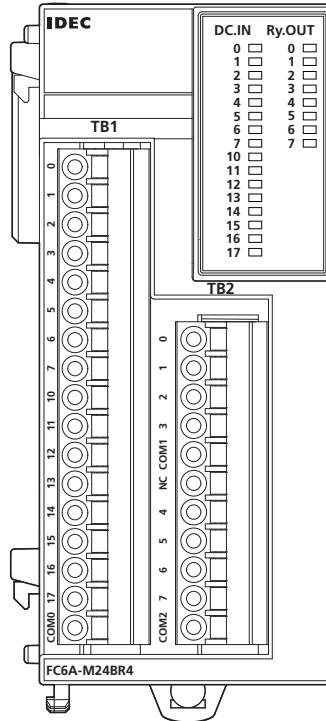
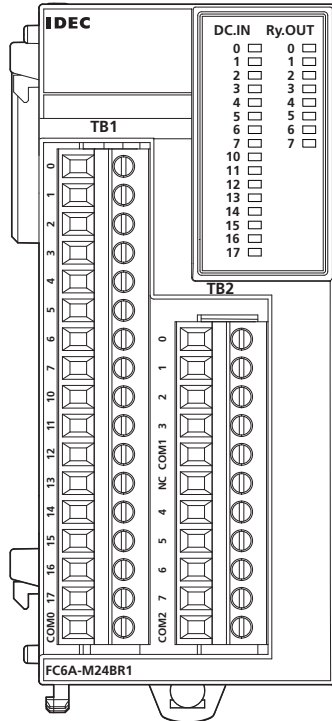

The 3 COM lines are connected in the module.
For wiring precautions, see "Input/Output Wiring" on page 3-18.

DC Sink Input Wiring Example

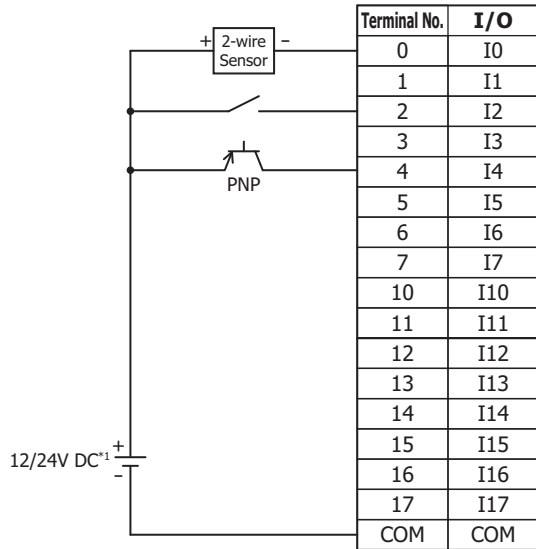

*1 24V DC for products with a version number lower than V400. For details on the version number of modules, see "Checking the Version Number" on page 2-1.

2: PRODUCT SPECIFICATIONS

DC Source Input Wiring Example

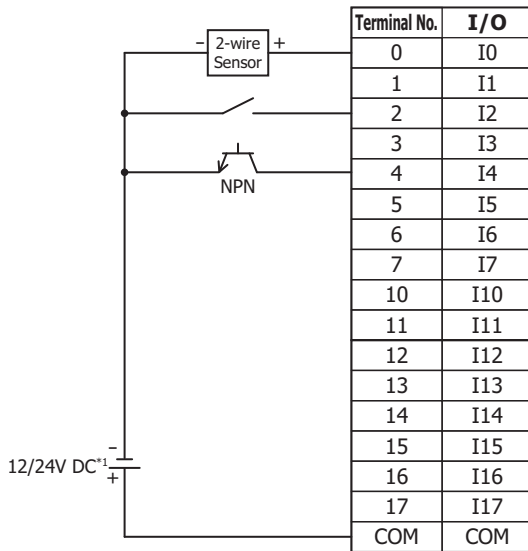

*1 24V DC for products with a version number lower than V400. For details on the version number of modules, see "Checking the Version Number" on page 2-1.

Relay Output Wiring Example

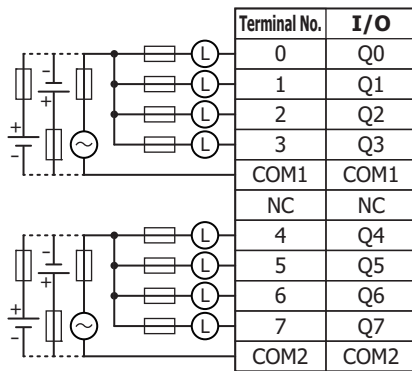

Insert a fuse that corresponds to the load.

Analog I/O Modules

Three type of analog I/O modules are available: analog input modules equipped with input terminals, analog output modules equipped with output terminals, and analog mixed I/O modules equipped with both input and output terminals.

Parts Description

Example: FC6A-J2C1

Example: FC6A-L06A1

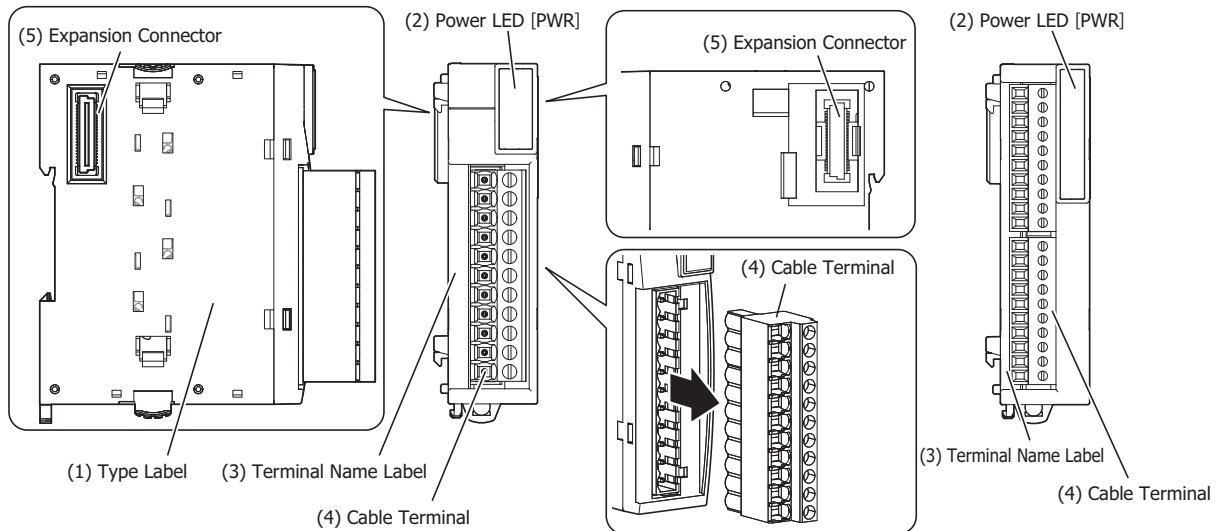

(1) Type Label

Indicates the analog I/O module type no. and specifications.

(2) Power LED [PWR]

This LED turns on when the power is supplied to the analog I/O module.

(3) Terminal Name Label

Indicates terminal numbers.

(4) Cable Terminal

Two types of terminals are separately available: the terminal block type (3.81 mm pitch) and the terminal block type (5.08 mm pitch).

(5) Expansion Connector

Connects the expansion modules and the CPU module.

2: PRODUCT SPECIFICATIONS

Model List

Module Type	I/O Points	I/O Signal	Cable Terminal Type 1	Cable Terminal Type 2	Type No.	
Analog input module	Input	2	Voltage input (0 to 10 V, -10 to +10 V) Current input (4 to 20 mA, 0 to 20 mA)	Terminal block type (5.08 mm pitch)	Screw fastened type	FC6A-J2C1
					Push-in type	FC6A-J2C4
		4	Voltage input (0 to 10 V, -10 to +10 V) Current input (4 to 20 mA, 0 to 20 mA)	Terminal block type (3.81 mm pitch)	Screw fastened type	FC6A-J4A1
					Push-in type	FC6A-J4A4
		8	Voltage input (0 to 10 V, -10 to +10 V) Current input (4 to 20 mA, 0 to 20 mA)	Terminal block type (3.81 mm pitch)	Screw fastened type	FC6A-J8A1
					Push-in type	FC6A-J8A4
		4	Voltage input (0 to 10 V, -10 to +10 V) Current input (4 to 20 mA, 0 to 20 mA) Thermocouple (K, J, R, S, B, E, T, N, C) Resistance thermometer (Pt100, Pt1000, Ni100, Ni1000)	Terminal block type (3.81 mm pitch)	Screw fastened type	FC6A-J4CN1
Push-in type	FC6A-J4CN4					
4	Thermocouple (K, J, R, S, B, E, T, N, C)	Terminal block type (3.81 mm pitch)	Screw fastened type	FC6A-J4CH1Y		
			Push-in type	FC6A-J4CH4Y		
8	Thermocouple (K, J, R, S, B, E, T, N, C) Thermistor (PTC, NTC) Resistance (100 to 32,000 Ω)	Terminal block type (3.81 mm pitch)	Screw fastened type	FC6A-J8CU1		
			Push-in type	FC6A-J8CU4		
Analog output module	Output	2	Voltage output (0 to 10 V, -10 to +10 V) Current output (4 to 20 mA, 0 to 20 mA)	Terminal block type (5.08 mm pitch)	Screw fastened type	FC6A-K2A1
					Push-in type	FC6A-K2A4
		4	Voltage output (0 to 10 V, -10 to +10 V) Current output (4 to 20 mA, 0 to 20 mA)	Terminal block type (5.08 mm pitch)	Screw fastened type	FC6A-K4A1
					Push-in type	FC6A-K4A4
Mixed analog I/O module	I/O	2 (Input)	Voltage input (0 to 10 V, -10 to +10 V) Current input (4 to 20 mA, 0 to 20 mA) Thermocouple (K, J, R, S, B, E, T, N, C) Resistance thermometer (Pt100, Pt1000, Ni100, Ni1000)	Terminal block type (5.08 mm pitch)	Screw fastened type	FC6A-L03CN1
					Push-in type	FC6A-L03CN4
	I/O	1 (Output)	Voltage output (0 to 10 V, -10 to +10 V) Current output (4 to 20 mA, 0 to 20 mA)	Terminal block type (3.81 mm pitch)	Screw fastened type	FC6A-L06A1
					Push-in type	FC6A-L06A4

Power Supply Specifications

Type No.		FC6A-J2C1 FC6A-J2C4	FC6A-J4A1 FC6A-J4A4	FC6A-J8A1 FC6A-J8A4	FC6A-J4CN1 FC6A-J4CN4	FC6A-J4CH1Y FC6A-J4CH4Y
External Power	Power Supply Voltage	12/24V DC*2				
	Allowed Fluctuation Range	10.2 to 28.8V DC				
Terminal Arrangement		2-116	2-117	2-118	2-119	2-120
Connector Module	Insertion/Removal Durability	100 times minimum				
Internal Current Draw	5V DC	40 mA	45 mA	40 mA	50 mA	50 mA
	24V DC	0 mA	0 mA	0 mA	0 mA	0 mA
Module External Power Supply Current Draw*1		50 mA (12V DC) 25 mA (24V DC)	60 mA (12V DC) 30 mA (24V DC)	80 mA (12V DC) 40 mA (24V DC)	80 mA (12V DC) 40 mA (24V DC)	80 mA (12V DC) 40 mA (24V DC)
Weight (approx.)		FC6A-J2C1: 115 g FC6A-J2C4: 100 g	FC6A-J4A1: 110 g FC6A-J4A4: 100 g	FC6A-J8A1: 110 g FC6A-J8A4: 100 g	FC6A-J4CN1: 110 g FC6A-J4CN4: 100 g	FC6A-J4CH1Y: 110 g FC6A-J4CH4Y: 100 g

*1 The value when the input is not open and the output is 100% output.

*2 24V DC for products with a version number lower than V400. For details on the version number of modules, see "Checking the Version Number" on page 2-1.

Type No.		FC6A-J8CU1 FC6A-J8CU4	FC6A-K2A1 FC6A-K2A4	FC6A-K4A1 FC6A-K4A4	FC6A-L03CN1 FC6A-L03CN4	FC6A-L06A1 FC6A-L06A4
External Power	Power Supply Voltage	12/24V DC*2		24V DC	12/24V DC*2	24V DC
	Allowed Fluctuation Range	10.2 to 28.8V DC		20.4 to 28.8V DC	10.2 to 28.8V DC	20.4 to 28.8V DC
Terminal Arrangement		2-121	2-122	2-123	2-124	2-125
Connector Module	Insertion/Removal Durability	100 times minimum				
Internal Current Draw	5V DC	45 mA	40 mA	50 mA	60 mA	55 mA
	24V DC	0 mA	0 mA	0 mA	0 mA	0 mA
Module External Power Supply Current Draw*1		60 mA (12V DC) 30 mA (24V DC)	140 mA (12V DC) 70 mA (24V DC)	125 mA (24V DC)	160 mA (12V DC) 80 mA (24V DC)	100 mA (24V DC)
Weight (approx.)		FC6A-J8CU1: 110 g FC6A-J8CU4: 100 g	FC6A-K2A1: 115 g FC6A-K2A4: 100 g	FC6A-K4A1: 115 g FC6A-K4A4: 100 g	FC6A-L03CN1: 115 g FC6A-L03CN4: 100 g	FC6A-L06A1: 110 g FC6A-L06A4: 100 g

*1 The value when the input is not open and the output is 100% output.

*2 24V DC for products with a version number lower than V400. For details on the version number of modules, see "Checking the Version Number" on page 2-1.

2: PRODUCT SPECIFICATIONS

Function Specifications

■ Analog Input Specifications

Analog Input Module

Type No.	FC6A-J2C1 FC6A-J2C4	FC6A-J4A1 FC6A-J4A4	FC6A-J8A1 FC6A-J8A4	FC6A-J4CN1 FC6A-J4CN4	FC6A-J4CH1Y FC6A-J4CH4Y	FC6A-J8CU1 FC6A-J8CU4	
Input Type and Input Range	Voltage	0 to 10 V -10 to 10 V			—		
	Current	4 to 20 mA 0 to 20 mA			—		
	Thermocouple	—			(K) -200 to 1,300°C (-328 to 2,372°F) (J) -200 to 1,000°C (-328 to 1,832°F) (R) 0 to 1,760°C (32 to 3,200°F) (S) 0 to 1,760°C (32 to 3,200°F) (B) 0 to 1,820°C (32 to 3,308°F) (E) -200 to 800°C (-328 to 1,472°F) (T) -200 to 400°C (-328 to 752°F) (N) -200 to 1,300°C (-328 to 2,372°F) (C) 0 to 2,315°C (32 to 4,199°F)		
	Resistance Thermometer*1	—			Pt100: -200 to 850°C (-328 to 1,562°F) Pt1000: -200 to +600°C (-328 to 1,112°F) Ni100: -60 to +180°C (-76 to 356°F) Ni1000: -60 to +180°C (-76 to 356°F)		
	Thermistor	—			NTC (-90 to 150°C) PTC (100 to 10,000 Ω)		
	Resistor	—			100 to 32,000 Ω		
Input Impedance	Voltage	1 MΩ or higher					
	Current	50 Ω or lower					
	Thermocouple	1 MΩ or higher					
	Resistance Thermometer	1 MΩ or higher					
	Thermistor	1 MΩ or higher					
	Resistor	1 MΩ or higher					
AD Conversion	Sampling Time	1 ms	1 ms or 10 ms	10 ms, 100 ms or 104 ms	120 ms or 30 ms	104 ms	
	Sampling Repetition Time	Sampling time × Number of enabled input channels					
	Total Input Delay Time*2	Sampling time + Sampling repetition time + 1 scan time					
	Type of Input	Single-ended			Differential input	Single-ended	
	Operation Mode	Self-scan					
	Conversion Method	ΣΔ type ADC					
Input Error	Maximum Error at 25°C	±0.1% of full scale	±0.2% of full scale	±0.2% of full scale Cold junction compensation accuracy: ±4.0°C or lower Exceptions R, S: ±6°C (0 to 200°C) B: Not possible to guarantee accuracy (0 to 300°C) K, J, E, T, N: ±0.4% of full scale (0°C or lower)			
	Temperature Coefficient	0.006%/°C	0.01%/°C				

Type No.		FC6A-J2C1 FC6A-J2C4	FC6A-J4A1 FC6A-J4A4	FC6A-J8A1 FC6A-J8A4	FC6A-J4CN1 FC6A-J4CN4	FC6A-J4CH1Y FC6A-J4CH4Y	FC6A-J8CU1 FC6A-J8CU4		
Data	Digital Resolution	Voltage	65,536 (16 bits)	4,096 (12 bits)	65,536 (16 bits)*3	65,536 (16 bits)	—		
		Current	65,536 (16 bits)	4,096 (12 bits)	65,536 (16 bits)*3	65,536 (16 bits)	—		
		Thermocouple	—			K: 15,000 (14 bits) J: 12,000 (14 bits) R: 17,600 (15 bits) S: 17,600 (15 bits) B: 18,200 (15 bits) E: 10,000 (14 bits) T: 6,000 (13 bits) N: 15,000 (14 bits) C: 23,150 (15 bits)			
		Resistance Thermometer	—			Pt100: 10,500 (14 bits) Pt1000: 8,000 (13 bits) Ni100: 2,400 (12 bits) Ni1000: 2,400 (12 bits)			
		Thermistor	—					NTC: 2,400 (12 bit) PTC: 9,900 (14 bit)	
		Resistor	—					31,900 (15 bit)	
	Input Value per Step	Voltage	0.15 mV (0 to 10 V) 0.30 mV (-10 to +10 V)	2.44 mV (0 to 10 V) 4.88 mV (-10 to +10 V)	0.15 mV (0 to 10 V)*3 0.30 mV (-10 to +10 V)*3	0.15 mV (0 to 10 V) 0.30 mV (-10 to +10 V)	—		
		Current	0.30 µA (0 to 20 mA) 0.244 µA (4 to 20 mA)	4.88 µA (0 to 20 mA) 3.91 µA (4 to 20 mA)	0.30 µA (0 to 20 mA)*3 0.244 µA (4 to 20 mA)*3	0.30 µA (0 to 20 mA) 0.244 µA (4 to 20 mA)	—		
		Thermocouple	—			0.1°C or 0.18°F			
		Resistance Thermometer	—			0.1°C or 0.18°F			
		Thermistor (NTC)	—			0.1°C or 0.18°F			
		Thermistor (PTC)	—					1 Ω	
	Data Type in Application Program		Can be arbitrarily set for each CH in a range between -32,768 to 32,767*4						
	Monotonicity		Yes						
	Input Data Out of Range		Detectable*5						
Noise Resistance	Maximum Temporary Deviation during Electrical Noise Tests	±4.0% or lower							
	Input Filter	Yes							
	Recommended Cable for Noise Immunity	Current/voltage: Pair shielded cable Other: Pair cable							
	Crosstalk	1 LSB or lower							
Isolation	Between Input and Power Circuit	Isolated power supply							
	Between Input and Internal Circuit	Photocoupler isolated							
	Between Inputs	—				Photocoupler isolated	—		
Effect of Improper Input Connection		No damage							

2: PRODUCT SPECIFICATIONS

Type No.	FC6A-J2C1 FC6A-J2C4	FC6A-J4A1 FC6A-J4A4	FC6A-J8A1 FC6A-J8A4	FC6A-J4CN1 FC6A-J4CN4	FC6A-J4CH1Y FC6A-J4CH4Y	FC6A-J8CU1 FC6A-J8CU4
Maximum Permanent Allowed Overload (No Damage)	30V DC, 160mA or lower*6					
Selection of Input Type and Input Range	Using programming software					
Calibration or Verification to Maintain Rated Accuracy	Not possible					

- *1 The resistance (allowable conductor resistance) of the electrical leads to connect to the resistance thermometer is 10 Ω or less per wire.
- *2 The total input delay time increases in proportion to the number of channels used. Input channels that have been set to unused are not included in the number of enabled input channels.
- *3 FC6A-J8A1 and FC6A-J8A4 (Version lower than 200) supports 4096 (12 bits) digital resolution.
The input values per step are as follows:
Voltage: 2.44 mV (0 to 10 V), 4.88 mV (-10 to +10 V)
Current: 4.88 μA (0 to 20 mA), 3.91 μA (4 to 20 mA)
When using FC6A-J8A1/FC6A-J8A4 (Version 200 or later), the digital resolution can be selected from 12 bits or 16 bits in Analog I/O Module Configuration dialog box in WindLDR.
- *4 The arbitrary setting is a function that uses the digital resolution data by scaling it to arbitrary data (that arbitrarily sets the lower limit value and the upper limit value). The range setting (-32,768 to 32,767) is specified with data registers.
Example: When -5 V is input, 1,024 is displayed as long as the arbitrary setting is not configured, but -500 is displayed when the arbitrary setting is configured as upper limit value = 1,000 and lower limit value = -1,000, and this makes it easier to intuitively read the input voltage value.

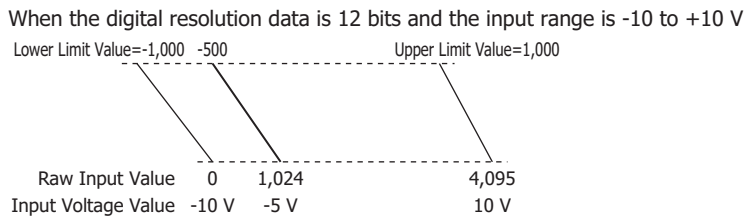

- *5 Input data out of range is reflected in the status of the analog I/O module.
- *6 For products with a version lower than 200, the maximum permanent allowed overload is 13V DC (when the voltage input is set) and 40mA DC (when the current input is set). If a current of 160mA or higher (at an ambient temperature of 25°C) flows through the circuit, the protection function for the input circuit starts operating and works to reduce the applied current. However, the circuit will be damaged if the applied current is due to voltage applied at 30V DC or higher. For details on the version number of modules, see "Checking the Version Number" on page 2-1.

Mixed Analog I/O Module

Type No.	FC6A-L06A1, FC6A-L06A4	FC6A-L03CN1, FC6A-L03CN4
Input Type and Input Range	Voltage	0 to 10 V -10 to 10 V
	Current	4 to 20 mA 0 to 20 mA
	Thermocouple	— (K) -200 to 1,300°C (-328 to 2,372°F) (J) -200 to 1,000°C (-328 to 1,832°F) (R) 0 to 1,760°C (32 to 3,200°F) (S) 0 to 1,760°C (32 to 3,200°F) (B) 0 to 1,820°C (32 to 3,308°F) (E) -200 to 800°C (-328 to 1,472°F) (T) -200 to 400°C (-328 to 752°F) (N) -200 to 1,300°C (-328 to 2,372°F) (C) 0 to 2,315°C (32 to 4,199°F)
	Resistance Thermometer*1	— Pt100: -200 to +850°C (-328 to 1,562°F) Pt1000: -200 to +600°C (-328 to 1,112°F) Ni100: -60 to +180°C (-76 to 356°F) Ni1000: -60 to +180°C (-76 to 356°F)
	Thermistor Resistor	— —

Type No.	FC6A-L06A1, FC6A-L06A4		FC6A-L03CN1, FC6A-L03CN4	
Input Impedance	Voltage	1 MΩ or higher		
	Current	50 Ω or lower		
	Thermocouple	1 MΩ or higher		
	Resistance Thermometer	1 MΩ or higher		
	Thermistor	1 MΩ or higher		
	Resistor	1 MΩ or higher		
AD Conversion	Sampling Time	1 ms or 10 ms	10 ms, 100 ms, or 104 ms	
	Sampling Repetition Time	Sampling time × Number of enabled input channels		
	Total Input Delay Time* ²	Sampling time + Sampling repetition time + 1 scan time		
	Type of Input	Single-ended		
	Operation Mode	Self-scan		
	Conversion Method	ΣΔ type ADC		
Input Error	Maximum Error at 25°C	±0.2% of full scale	±0.1% of full scale	
	Temperature Coefficient	0.01% of full scale/°C	0.006% of full scale/°C	
Data	Digital Resolution	Voltage	4,096 (12 bits)	65,536 (16 bits)
		Current	4,096 (12 bits)	65,536 (16 bits)
		Thermocouple	—	K: 15,000 (14 bits) J: 12,000 (14 bits) R: 17,600 (15 bits) S: 17,600 (15 bits) B: 18,200 (15 bits) E: 10,000 (14 bits) T: 6,000 (13 bits) N: 15,000 (14 bits) C: 23,150 (15 bits)
		Resistance Thermometer	—	Pt100: 10,500 (14 bits) Pt1000: 8,000 (13 bits) Ni100: 2,400 (12 bits) Ni1000: 2,400 (12 bits)
		Thermistor	—	—
	Resistor	—	—	
	Input Value per Step	Voltage	2.44 mV (0 to 10 V) 4.88 mV (-10 to +10 V)	0.15 mV (0 to 10 V) -0.30 mV (-10 to +10 V)
		Current	4.88 μA (0 to 20 mA) 3.91 μA (4 to 20 mA)	0.30 μA (0 to 20 mA) 0.244 μA (4 to 20 mA)
		Thermocouple	—	0.1°C or 0.18°F
		Resistance Thermometer		
Thermistor (NTC)		—	—	
Thermistor (PTC)	—	—		
Data Type in Application Program	Can be arbitrarily set for each CH in a range between -32,768 to 32,767* ³			
Monotonicity	Yes			
Input Data Out of Range	Detectable* ⁴			
Noise Resistance	Maximum Temporary Deviation during Electrical Noise Tests	±4% or less of full scale		
	Input Filter	Yes		
	Recommended Cable for Noise Immunity	Current/voltage: Pair shielded cable Wire length: 30 m or shorter Other: Pair cable Wire length: 30 m or shorter		
	Crosstalk	1 LSB or lower		
Isolation	Between Input and Power Circuit	Transformer isolated		
	Between Input and Internal Circuit	Photocoupler isolated		
Effect of Improper Input Connection	No damage			
Maximum Permanent Allowed Overload (No Damage)	30V DC, 160mA or lower* ⁵			
Selection of Input Type and Input Range	Using programming software			
Calibration or Verification to Maintain Rated Accuracy	Not possible			

*1 The resistance (allowable conductor resistance) of the electrical leads to connect to the resistance thermometer is 10 Ω or less per wire.

2: PRODUCT SPECIFICATIONS

- *2 The total input delay time increases in proportion to the number of channels used. Input channels that have been set to unused are not included in the number of enabled input channels.
- *3 The arbitrary setting is a function that uses the digital resolution data by scaling it to arbitrary data (that arbitrarily sets the lower limit value and the upper limit value). The range setting (-32,768 to 32,767) is specified with data registers.
- *4 Input data out of range is reflected in the status of the analog I/O module.
- *5 For products with a version lower than 200, the maximum permanent allowed overload is 13V DC (when the voltage input is set) and 40mA DC (when the current input is set). If a current of 160mA or higher (at an ambient temperature of 25°C) flows through the circuit, the protection function for the input circuit starts operating and works to reduce the applied current. However, the circuit will be damaged if the applied current is due to voltage applied at 30V DC or higher. For details on the version number of modules, see "Checking the Version Number" on page 2-1.

Input Internal Circuit

FC6A-J2C1, FC6A-J2C4, FC6A-J4A1, FC6A-J4A4, FC6A-J8A1, FC6A-J8A4, FC6A-L06A1, FC6A-L06A4

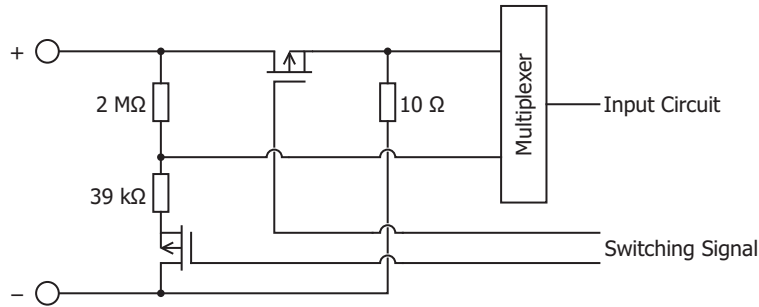

FC6A-J4CN1, FC6A-J4CN4, FC6A-L03CN1, FC6A-L03CN4

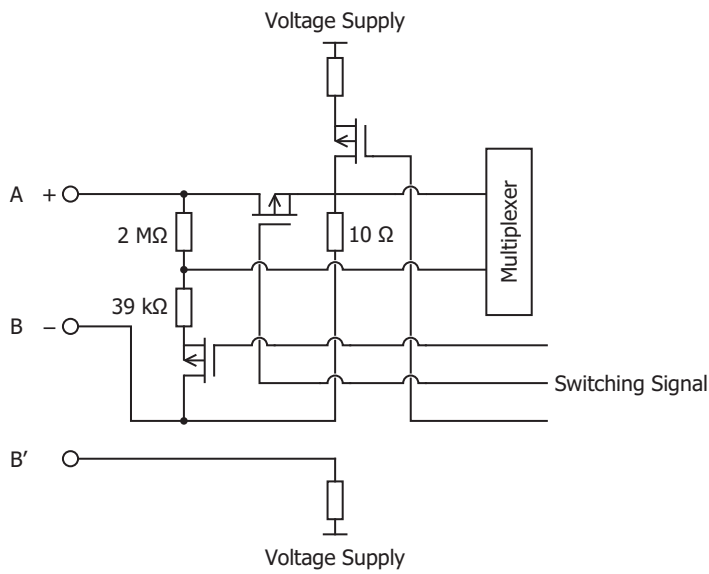

FC6A-J8CU1, FC6A-J8CU4

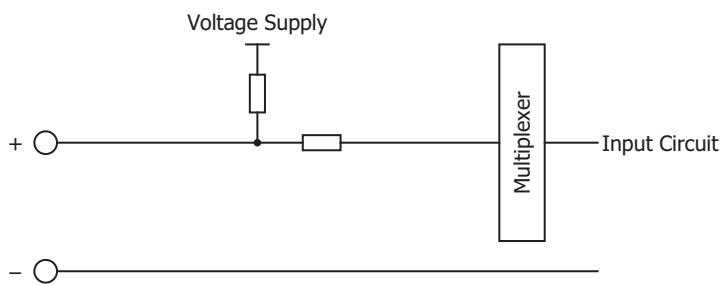

FC6A-J4CH1Y, FC6A-J4CH4Y

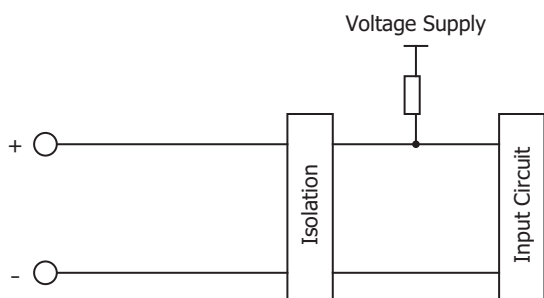

2: PRODUCT SPECIFICATIONS

■ Analog Output Specifications

Output Type and Output Range		Voltage	Current
		0 to 10 V -10 to 10 V	4 to 20 mA 0 to 20 mA
Load	Impedance	1 k Ω or higher	300 Ω or lower
	Load Type	Resistive load	
DA Conversion	DA Conversion Time	1 ms	
	Output Update Interval	1 ms	
	Total Output System Transfer Time	DA conversion time + Output Update Interval + 1 scan time	
Output Error	Maximum Error at 25°C	FC6A-L03CN1	$\pm 0.1\%$ of full scale
		FC6A-L03CN4	
		FC6A-L06A1	
		FC6A-L06A4	
		FC6A-K2A1	
		FC6A-K2A4	
		FC6A-K4A1	
		FC6A-K4A4	
	Temperature Coefficient	FC6A-L03CN1	0.006% of full scale/°C
		FC6A-L03CN4	
		FC6A-L06A1	
		FC6A-L06A4	
		FC6A-K2A1	
		FC6A-K2A4	
FC6A-K4A1			
FC6A-K4A4			
Output Ripple		1 LSB or lower	
Overshoot		0%	
Data	Digital Resolution	4,096 steps (12 bits)	
	Input Value per Step	2.44 mV (0 to 10 V)	
		4.88 mV (-10 to +10 V)	
		4.88 μ A (0 to 20 mA)	
		3.91 μ A (4 to 20 mA)	
Application	Can be arbitrarily set for each CH in a range between -32,768 to 32,767 ^{*1}		
Monotonicity	Yes		
Current Loop Open	Not detectable		
Noise Resistance	Maximum Temporary Deviation during Electrical Noise Tests	$\pm 4\%$ or less of full scale	
	Recommended Cable for Noise Immunity	Current/voltage: Pair shielded cable Other: Pair cable	
	Crosstalk	1 LSB	
Isolation	Between Output and Power Circuit	Transformer isolated	
	Between Output and Internal Circuit	Photocoupler isolated	
Effect of Improper Output Connection		No damage	
Selection of Analog Output Signal Type		Using programming software	
Calibration or Verification to Maintain Rated Accuracy		Not possible	

*1 The arbitrary setting is a function that uses the digital resolution data by scaling it to arbitrary data (that arbitrarily sets the lower limit value and the upper limit value). The range setting (-32,768 to 32,767) is specified with data registers.

Output Internal Circuit

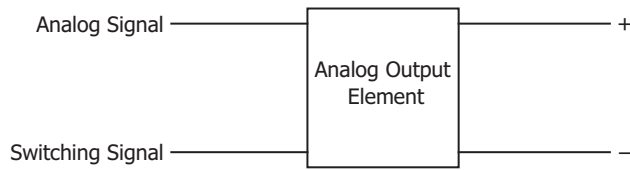

Ambient Temperature and Analog Input/Output Restrictions

- Certain models of the analog module do not support expanded ambient operating temperatures (-25 to -10°C and 55 to 65°C). Do not use unsupported models in an environment with expanded ambient operating temperatures.
- For the status of support for expanded ambient operating temperatures, see "Status of Support for Expanded Ambient Operating Temperatures (-25 to -10°C and 55 to 65°C)" on page 2-2.
- When using the product in high temperatures that exceed 55°C, do not use analog current output from the FC6A-L03CN1 or FC6A-L03CN4. For other models, there are no restrictions on analog input/output.

2: PRODUCT SPECIFICATIONS

Terminal Arrangement and Wiring Examples

Caution

- When connecting the terminal, insert an IEC 60127-approved fuse suitable for the applied voltage and current draw at the position shown in the following diagram.
(Applicable when equipment containing the FC6A Series MICROSmart is destined for Europe)
- Do not connect a thermocouple to a part with hazardous voltage (60V DC or peak 42.4V DC or higher part).
- Before turning on the power, always check the wiring. If wiring is incorrect, the analog I/O module may be damaged.

FC6A-J2C1, FC6A-J2C4

Screw fastened type: FC6A-J2C1

Applicable connector: FC6A-PMTB11PN02

Push-in type: FC6A-J2C4

Applicable connector: FC6A-PMSB11PN02

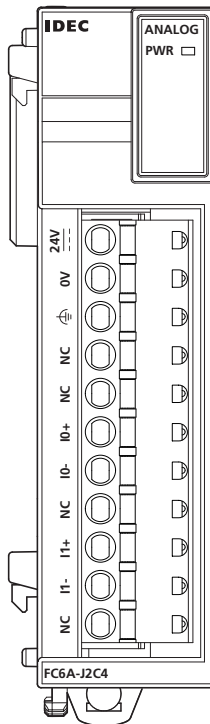
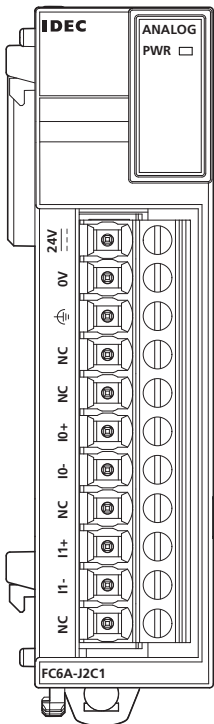

For wiring precautions, see "Input/Output Wiring" on page 3-18.

 : Fuse

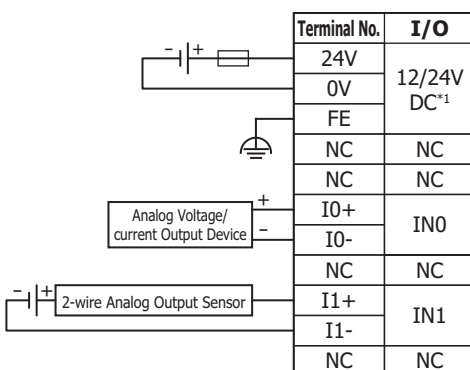

*1 24V DC for products with a version number lower than V400. For details on the version number of modules, see "Checking the Version Number" on page 2-1.

■ FC6A-J4A1, FC6A-J4A4

Screw fastened type: FC6A-J4A1

Applicable connector: FC6A-PMTC10PN02

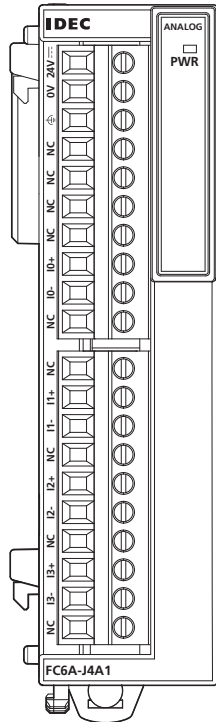

Push-in type: FC6A-J4A4

Applicable connector: FC6A-PMSC10PN02

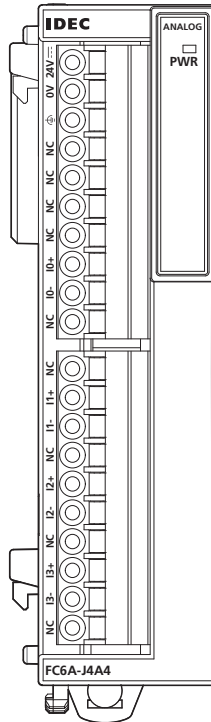

For wiring precautions, see "Input/Output Wiring" on page 3-18.

 : Fuse

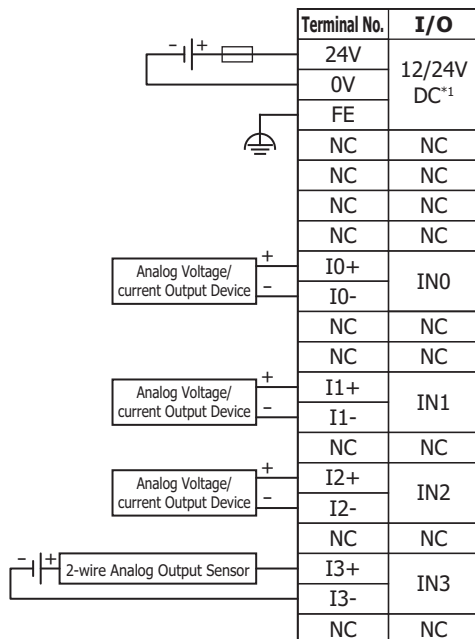

*1 24V DC for products with a version number lower than V400. For details on the version number of modules, see "Checking the Version Number" on page 2-1.

2: PRODUCT SPECIFICATIONS

■ FC6A-J8A1, FC6A-J8A4

Screw fastened type: FC6A-J8A1

Applicable connector: FC6A-PMTC10PN02

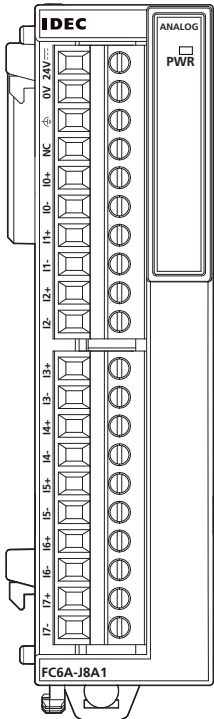

Push-in type: FC6A-J8A4

Applicable connector: FC6A-PMSC10PN02

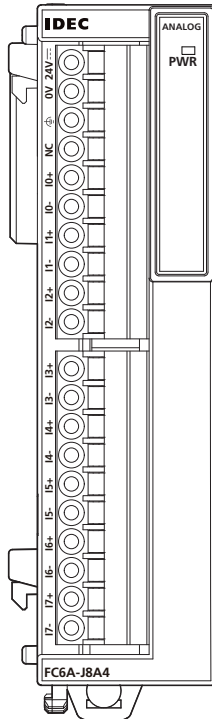

For wiring precautions, see "Input/Output Wiring" on page 3-18.

 : Fuse

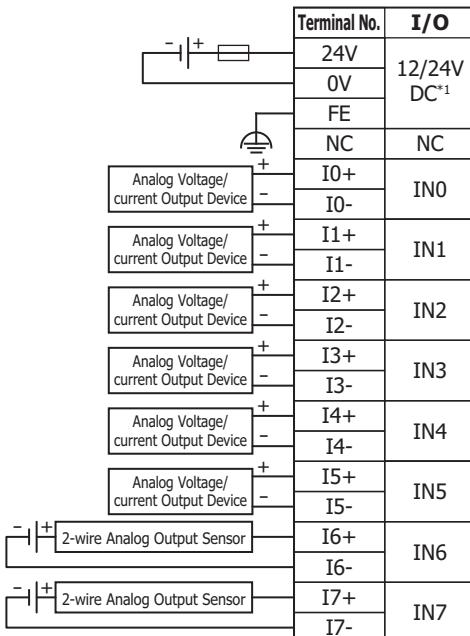

*1 24V DC for products with a version number lower than V400. For details on the version number of modules, see "Checking the Version Number" on page 2-1.

■ FC6A-J4CN1, FC6A-J4CN4

Screw fastened type: FC6A-J4CN1

Applicable connector: FC6A-PMTC10PN02

Push-in type: FC6A-J4CN4

Applicable connector: FC6A-PMSC10PN02

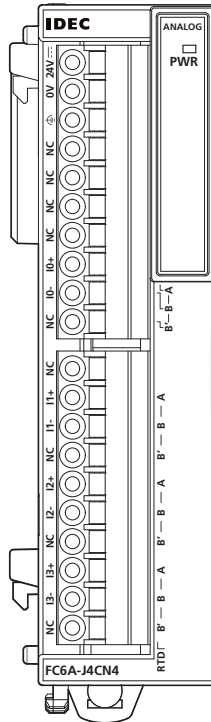
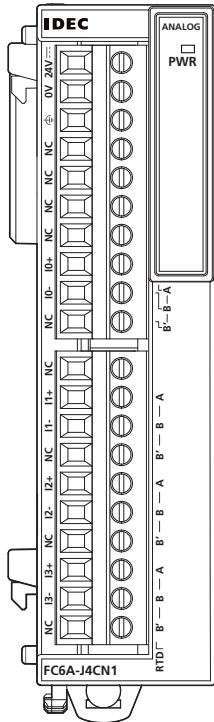

For wiring precautions, see "Input/Output Wiring" on page 3-18.

: Fuse

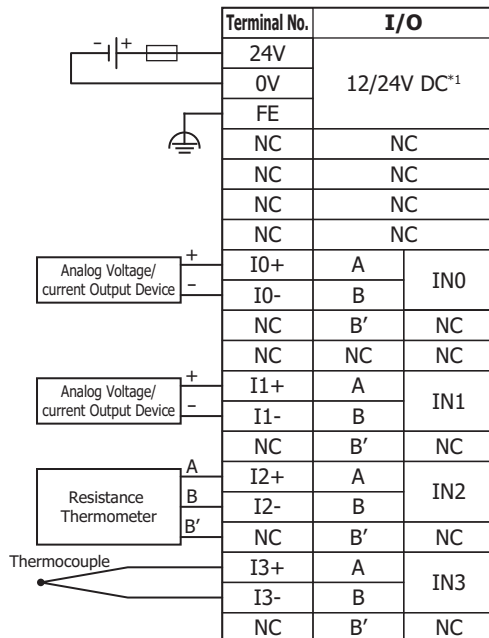

*1 24V DC for products with a version number lower than V400. For details on the version number of modules, see "Checking the Version Number" on page 2-1.

2: PRODUCT SPECIFICATIONS

■ FC6A-J4CH1Y, FC6A-J4CH4Y

Screw fastened type: FC6A-J4CH1Y

Applicable connector: FC6A-PMTC10PN02

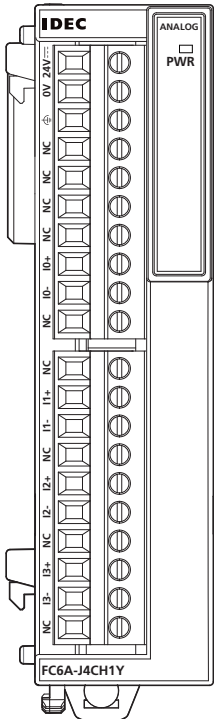

Push-in type: FC6A-J4CH4Y

Applicable connector: FC6A-PMSC10PN02

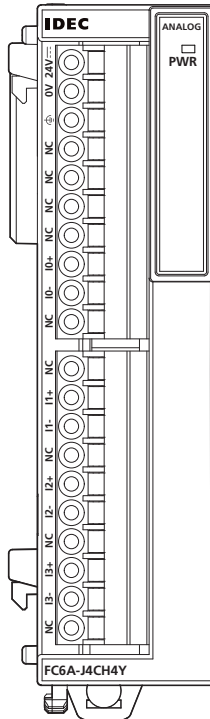

For wiring precautions, see "Input/Output Wiring" on page 3-18.

 : Fuse

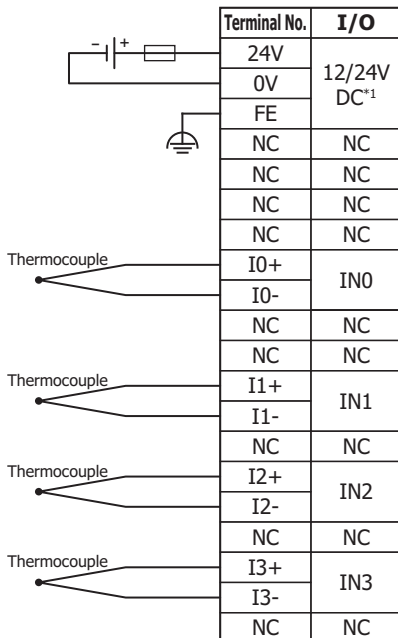

*1 24V DC for products with a version number lower than V400. For details on the version number of modules, see "Checking the Version Number" on page 2-1.

■ FC6A-J8CU1, FC6A-J8CU4

Screw fastened type: FC6A-J8CU1

Applicable connector: FC6A-PMTC10PN02

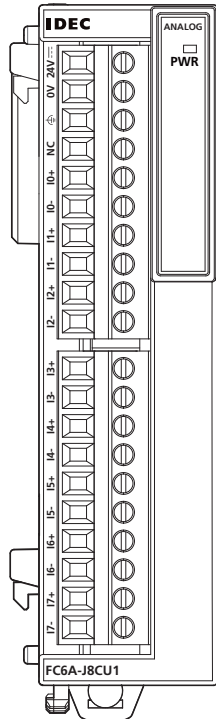

Push-in type: FC6A-J8CU4

Applicable connector: FC6A-PMSC10PN02

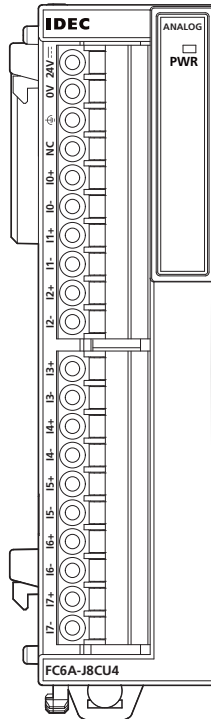

For wiring precautions, see "Input/Output Wiring" on page 3-18.

 : Fuse

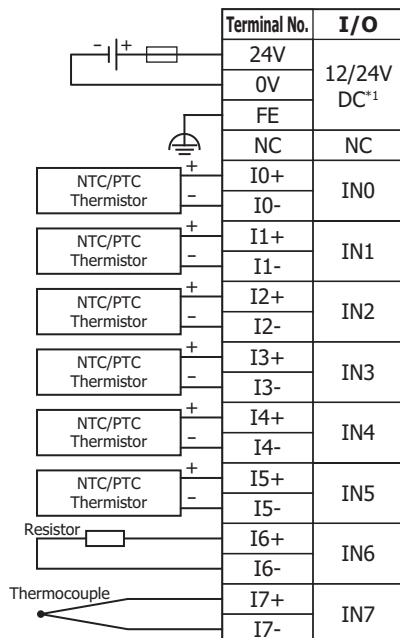

*1 24V DC for products with a version number lower than V400. For details on the version number of modules, see "Checking the Version Number" on page 2-1.

2: PRODUCT SPECIFICATIONS

■ FC6A-K2A1, FC6A-K2A4

Screw fastened type: FC6A-K2A1

Applicable connector: FC6A-PMTB11PN02

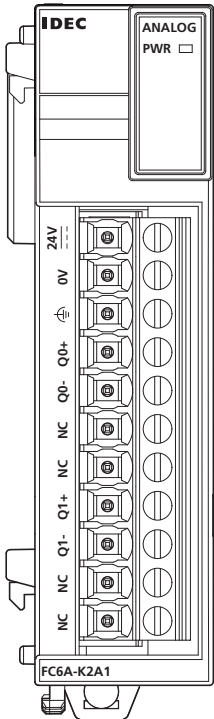

Push-in type: FC6A-K2A4

Applicable connector: FC6A-PMSB11PN02

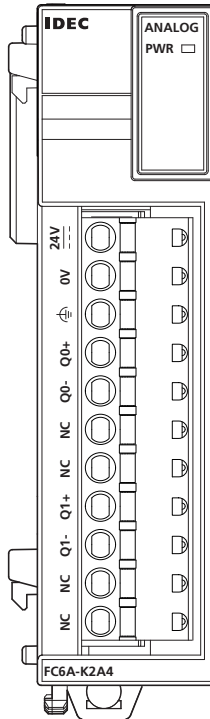

For wiring precautions, see "Input/Output Wiring" on page 3-18.

 : Fuse

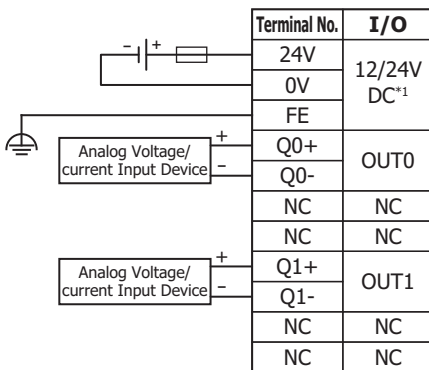

*1 24V DC for products with a version number lower than V400. For details on the version number of modules, see "Checking the Version Number" on page 2-1.

■ FC6A-K4A1, FC6A-K4A4

Screw fastened type: FC6A-K4A1

Applicable connector: FC6A-PMTB11PN02

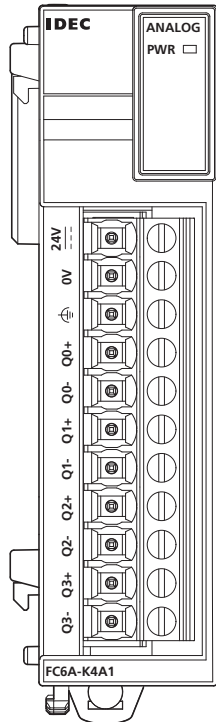

Push-in type: FC6A-K4A4

Applicable connector: FC6A-PMSB11PN02

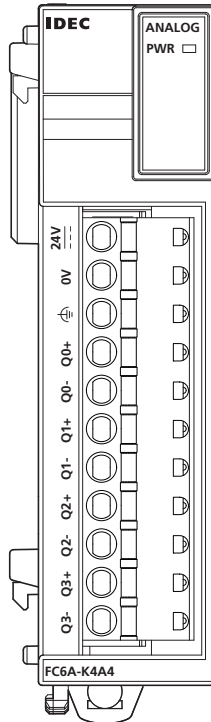

For wiring precautions, see "Input/Output Wiring" on page 3-18.

 : Fuse

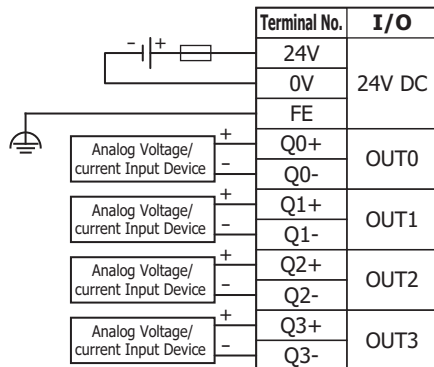

2: PRODUCT SPECIFICATIONS

■ FC6A-L03CN1, FC6A-L03CN4

Screw fastened type: FC6A-L03CN1

Applicable connector: FC6A-PMTB11PN02

Push-in type: FC6A-L03CN4

Applicable connector: FC6A-PMSB11PN02

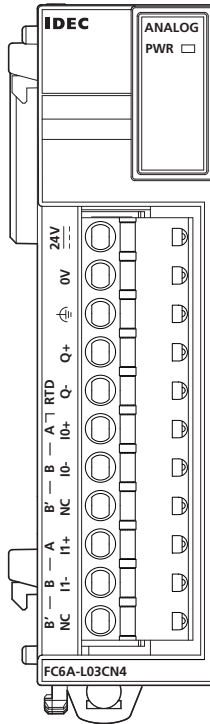
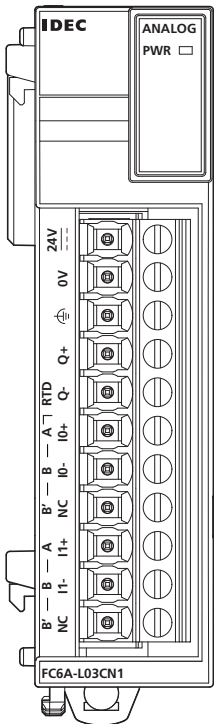

For wiring precautions, see "Input/Output Wiring" on page 3-18.

 : Fuse

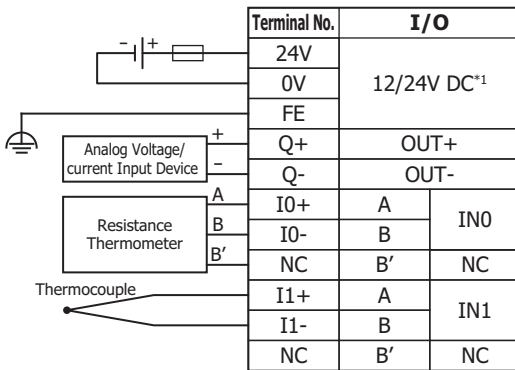

*1 24V DC for products with a version number lower than V400. For details on the version number of modules, see "Checking the Version Number" on page 2-1.

■ FC6A-L06A1, FC6A-L06A4

Screw fastened type: FC6A-L06A1

Applicable connector: FC6A-PMTC10PN02

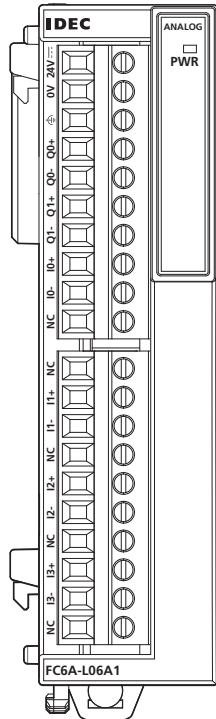

Push-in type: FC6A-L06A4

Applicable connector: FC6A-PMSC10PN02

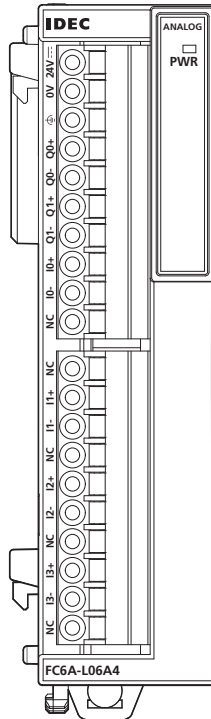

For wiring precautions, see "Input/Output Wiring" on page 3-18.

 : Fuse

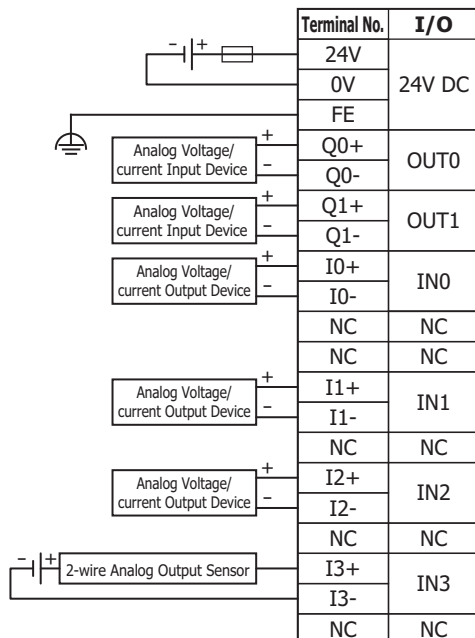

2: PRODUCT SPECIFICATIONS

Precautions when Supplying Power to the Analog I/O Module

Separate analog I/O lines (resistance thermometers in particular) from power lines as much as possible to reduce the effect of noise.

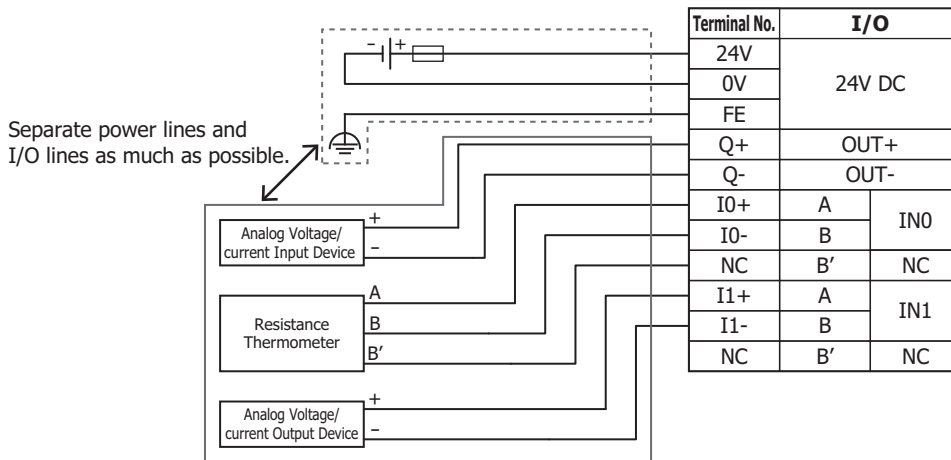

PID Module

The PID module performs control actions to eliminate the deviation between the set point (SP) and process variable (PV). The PID module, which is an expansion module, is required to connect to the CPU module for use. Depending on the difference of output specifications, the PID modules are categorized into two types.

The input channel can accept voltage, current, thermocouple or resistance thermometer signals. The output channel generates relay output, non-contact voltage (for SSR drive), or current signals.

To configure the PID modules, the Expansion Modules Configuration dialog box in WindLDR is used. For detailed configuration methods, see "Module Configuration Editor" on page 12-1. For details on the PID module parameter settings, see the "FC6A Series MICROSmart PID Module User's Manual".

Parts Description

Example: FC6A-F2M1

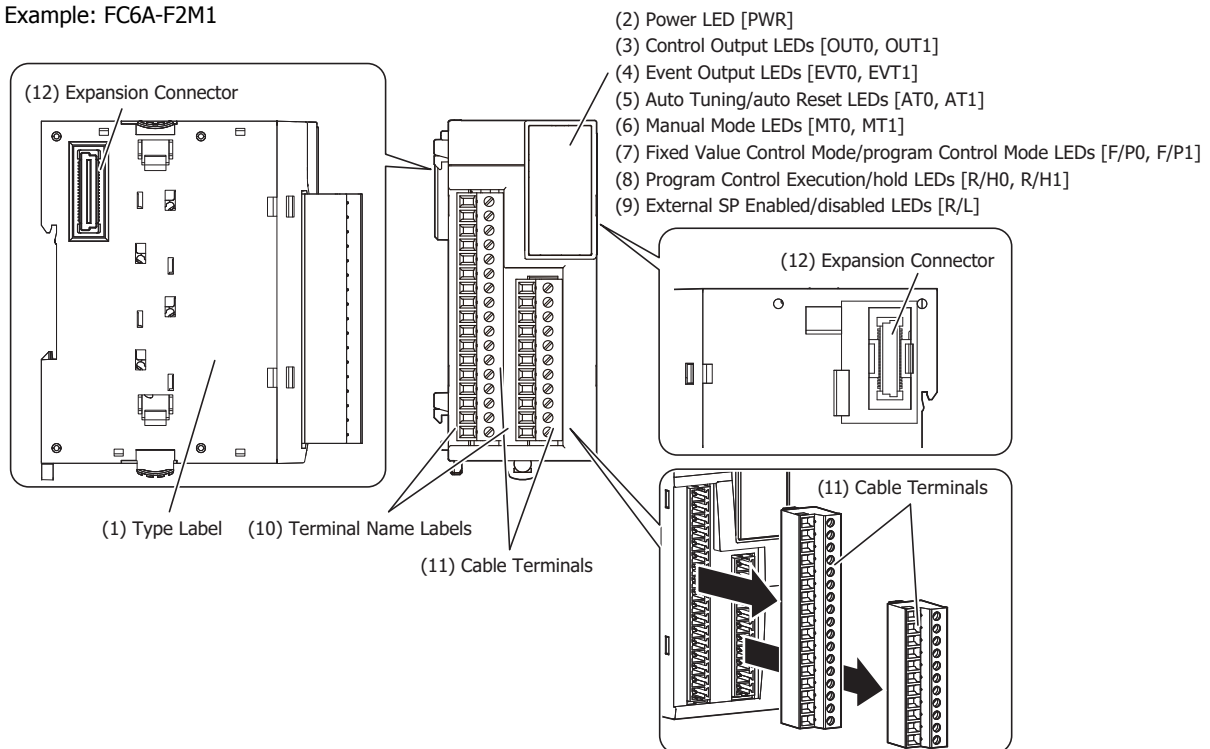

The content in brackets is the LED indicator name on the PID module.

LED Indicators

- PWR □(2)
- OUT0 □(3)
- EVT0 □(4)
- AT0 □(5)
- MT0 □(6)
- F/P0 □(7)
- R/H0 □(8)
- R/L □(9)
- OUT1 □(3)
- EVT1 □(4)
- AT1 □(5)
- MT1 □(6)
- F/P1 □(7)
- R/H1 □(8)

(1) Type Label

Indicates the PID module type no. and specifications.

(2) Power LED [PWR]

On: Power normally supplied

Flashing: When there is an external power supply (24V DC) fault

Off: Power is not supplied

2: PRODUCT SPECIFICATIONS

(3) Control Output LEDs [OUT0, OUT1]

On: Control output is on

Off: Control output is off

Flashing: For current output only, flashes at the duty cycle that corresponds to the output manipulated variable in a 100 ms cycle.

For an output manipulated variable of 20%, the LED is on for 20 ms and off for 80 ms.

(4) Event Output LEDs [EVT0, EVT1]

On: When alarm 1 to alarm 8 or a loop error alarm has occurred

Off: When no alarms have occurred

(5) Auto Tuning/auto Reset LEDs [AT0, AT1]

Flashing: When executing auto tuning or auto reset

Off: When auto tuning or auto reset is stopped

(6) Manual Mode LEDs [MT0, MT1]

On: When program control mode is selected

Off: When auto mode is selected

(7) Fixed Value Control Mode/program Control Mode LEDs [F/P0, F/P1]

On: During program control mode

Off: During fixed value control mode

(8) Program Control Execution/hold LEDs [R/H0, R/H1]

On: During program control execution or while control is allowed in fixed value control

Flashing: When there is a power interruption during program control hold or during program control execution

Off: During program control stopped or while control prohibited in fixed value control

(9) External SP Enabled/disabled LEDs [R/L]

On: External SP input is enabled

Off: External SP input is disabled

(10) Terminal Name Label

Indicates terminal numbers.

(11) Cable terminals

These terminals are for connecting cables. Terminal block type (3.81 mm pitch).

(12) Expansion connector

Connects the expansion modules and the CPU module.

Model List

Module type	I/O Points		I/O Signal	Cable Terminal Type 1	Cable Terminal Type 2	Type No.
Non-contact voltage output (to drive SSRs)/ current output type	I/O	2 (Input)	Voltage input (0 to 10 V, 0 to 5 V, 1 to 5 V, 0 to 1 V) Current input (4 to 20 mA, 0 to 20 mA) Thermocouple (K, J, R, S, B, E, T, N, PL-II, C) Resistance thermometer (Pt100, jPt100)	Terminal block type (3.81 mm pitch)	Screw fastened type	FC6A-F2M1
		2 (Output)	Voltage output (12V DC digital output) Current output (4 to 20 mA)		Push-in type	FC6A-F2M4
Relay contact output type	I/O	2 (Input)	Voltage input (0 to 10 V, 0 to 5 V, 1 to 5 V, 0 to 1 V) Current input (4 to 20 mA, 0 to 20 mA) Thermocouple (K, J, R, S, B, E, T, N, PL-II, C) Resistance thermometer (Pt100, jPt100)	Terminal block type (3.81 mm pitch)	Screw fastened type	FC6A-F2MR1
		2 (Output)	Relay output		Push-in type	FC6A-F2MR4

Quantity of Applicable PID Modules

The maximum number of PID modules that can be connected depends on the CPU module type. The maximum number of PID modules that can be connected to the CPU modules is as follows.

Module Type		Type No.	Quantity of Applicable PID Modules
All-in-One CPU module	All-in-One CPU module	FC6A-C16R1AE, FC6A-C16R4AE FC6A-C16R1CE, FC6A-C16R4CE FC6A-C16K1CE, FC6A-C16K4CE FC6A-C16P1CE, FC6A-C16P4CE FC6A-C16R1DE, FC6A-C16R4DE FC6A-C16K1DE, FC6A-C16K4DE FC6A-C16P1DE, FC6A-C16P4DE	4 modules + 8 modules* ¹
		FC6A-C24R1AE, FC6A-C24R4AE FC6A-C24R1CE, FC6A-C24R4CE FC6A-C24K1CE, FC6A-C24K4CE FC6A-C24P1CE, FC6A-C24P4CE	7 modules + 8 modules* ¹
	FC6A-C40R1AE, FC6A-C40R4AE FC6A-C40R1CE, FC6A-C40R4CE FC6A-C40K1CE, FC6A-C40K4CE FC6A-C40P1CE, FC6A-C40P4CE FC6A-C40R1DE, FC6A-C40R4DE FC6A-C40K1DE, FC6A-C40K4DE FC6A-C40P1DE, FC6A-C40P4DE		
	CAN J1939 All-in-One CPU module	FC6A-C40R1AEJ, FC6A-C40R4AEJ FC6A-C40R1CEJ, FC6A-C40R4CEJ FC6A-C40K1CEJ, FC6A-C40K4CEJ FC6A-C40P1CEJ, FC6A-C40P4CEJ FC6A-C40R1DEJ, FC6A-C40R4DEJ FC6A-C40K1DEJ, FC6A-C40K4DEJ FC6A-C40P1DEJ, FC6A-C40P4DEJ	
Plus CPU module	Plus CPU module	FC6A-D16R1CEE FC6A-D16R4CEE FC6A-D16K1CEE FC6A-D16K4CEE FC6A-D16P1CEE FC6A-D16P4CEE	63 modules* ²
		FC6A-D32K3CEE FC6A-D32K4CEE FC6A-D32P3CEE FC6A-D32P4CEE	

*1 When the expansion interface module (expander) is used, an additional eight PID modules can be connected to the expansion interface side (right side) of the expansion interface module (expander). The maximum number of modules that can be connected does not include the expansion interface module (expander).

*2 The number of modules that can be connected does not include the expansion interface modules (expander and remote master/slave).

2: PRODUCT SPECIFICATIONS

Power Supply Specifications

Type No.		FC6A-F2M1, FC6A-F2M4	FC6A-F2MR1, FC6A-F2MR4
External Power	Power Supply Voltage	24V DC	
	Allowed Fluctuation Range	20.4 to 28.8V DC	
Terminal Arrangement		See "Terminal Arrangement and Wiring Examples" on page 2-135	
Connector	Insertion/Removal Durability	100 times minimum	
Module	5V DC	65 mA	65 mA
Internal Current Draw	24V DC	0 mA	0 mA
Module External Power Supply Current Draw		150 mA (24V DC)	150 mA (24V DC)
Weight (approx.)		FC6A-F2M1: 140 g FC6A-F2M4: 130 g	FC6A-F2MR1: 140 g FC6A-F2MR4: 130 g

Function Specifications

■ Input Specifications

Type No.		FC6A-F2M1, FC6A-F2M4, FC6A-F2MR1, FC6A-F2MR4		
Input Type and Input Range	Voltage	0 to 10 V		
		0 to 5 V		
		1 to 5 V		
		0 to 1 V		
	Current	4 to 20 mA		
		0 to 20 mA		
	Thermocouple	K	-200 to 1,370°C	-328 to 2,498°F
		K (with decimal point)	-200.0 to 400.0°C	-328.0 to 752.0°F
		J	-200 to 1,000°C	-328 to 1,832°F
		R	0 to 1,760°C	32 to 3,200°F
		S	0 to 1,760°C	32 to 3,200°F
		B	0 to 1,820°C	32 to 3,308°F
		E	-200 to 800°C	-328 to 1,472°F
		T	-200.0 to 400.0°C	-328.0 to 752.0°F
N		-200 to 1,300°C	-328 to 2,372°F	
PL-II		0 to 1,390°C	32 to 2,534°F	
C (W/Re5-26)	0 to 2,315°C	32 to 4,199°F		
Resistance Thermometer*1	Pt100	-200 to 850°C	-328 to 1,562°F	
	Pt100 (with decimal point)	-200.0 to 850.0°C	-328.0 to 1,562.0°F	
	JPt100	-200 to 500°C	-328 to 932°F	
	JPt100 (with decimal point)	-200.0 to 500.0°C	-328.0 to 932.0°F	
Input Impedance	Voltage	1 MΩ or higher (0 to 1 V range) 100 kΩ or higher (other range)		
	Current	50 Ω or lower		
	Thermocouple	1 MΩ or higher		
	Resistance Thermometer	1 MΩ or higher		
AD Conversion	Sampling Time	100 ms		
	Sampling Repetition Time	100 ms		
	Total Input Delay Time*2	Sampling time + Sampling repetition time + 1 scan time		
	Type of Input	Differential input		
	Operation Mode	Self-scan		
	Conversion Method	ΣΔ type ADC		

Type No.		FC6A-F2M1, FC6A-F2M4, FC6A-F2MR1, FC6A-F2MR4			
Input Error	Maximum Error at 25°C	Thermocouple	Within ±0.2% of full scale or ±2°C (4°F), whichever is larger Cold junction compensation accuracy: ±1.0°C or lower However, R, S input 0 to 200°C (0 to 400°F) is within ±6°C (12°F) B input 0 to 300°C (0 to 600°F) is outside the guaranteed range of accuracy K, J, E, T, N input less than 0°C (32°F) is within ±0.4% of full scale		
		Resistance Thermometer	Within ±0.1% of full scale or ±1°C (2°F), whichever is larger		
		Voltage/Current	Within ±0.2% of full scale		
		Temperature Coefficient	±0.005% of full scale/°C		
Data	Digital Resolution	Voltage	12,000 (14 bits)		
		Current	12,000 (14 bits)		
		Thermocouple		Celsius (°C)	Fahrenheit (°F)
			K	1,570	2,826
			K (with decimal point)	6,000	10,800
			J	1,200	2,160
			R	1,760	3,169
			S	1,760	3,169
			B	1,820	3,277
			E	1,000	1,800
			T	6,000	10,800
			N	1,500	2,700
			PL-II	1,390	2,503
			C (W/Re5-26)	2,315	4,168
	Resistance Thermometer*1		Celsius (°C)	Fahrenheit (°F)	
		Pt100	1,050	1,890	
		Pt100 (with decimal point)	10,500	18,900	
		JPt100	700	1,260	
		JPt100 (with decimal point)	7,000	12,600	
	Input Value per Step	Voltage	0 to +10V DC: 0.83 mV		
0 to +5V DC: 0.416 mV					
Current		1 to +5V DC: 0.333 mV			
		0 to +1V DC: 0.083 mV			
Thermocouple		4 to 20mA DC: 1.333 µA	0 to 20mA DC: 1.666 µA		
			Type	Input Value per Step	
		K		1°C (°F)	
		K (with decimal point)		0.1°C (°F)	
		J		1°C (°F)	
		R		1°C (°F)	
		S		1°C (°F)	
		B		1°C (°F)	
		E		1°C (°F)	
		T		0.1°C (°F)	
	N		1°C (°F)		
	PL-II		1°C (°F)		
C (W/Re5-26)		1°C (°F)			

2: PRODUCT SPECIFICATIONS

Type No.	FC6A-F2M1, FC6A-F2M4, FC6A-F2MR1, FC6A-F2MR4			
Data	Input Value per Step	Resistance Thermometer	Type	
			Pt100	1°C (°F)
			Pt100 (with decimal point)	0.1°C (°F)
			JPt100	1°C (°F)
	JPt100 (with decimal point)	0.1°C (°F)		
	Data Type in Application Program	Can be arbitrarily set for each CH in a range between -32,768 to 32,767 ^{*2}		
Monotonicity	Yes			
Input Data Out of Range	Detectable ^{*3}			
Noise Resistance	Maximum Temporary Deviation during Electrical Noise Tests		±4% or less of full scale	
	Input Filter		Yes	
	Recommended Cable for Noise Immunity		Current/voltage: Pair shielded cable Other: Pair cable	
	Crosstalk		None	
Isolation	Between Input and Power Circuit		Transformer isolated	
	Between I/O and Internal Circuit		Photocoupler isolated	
	Between Inputs		Photocoupler isolated	
Effect of Improper Input Connection			No damage	
Maximum Permanent Allowed Overload (No Damage)			15V DC or lower (0 to 1 V range is 5V DC or lower), 50 mA or lower	
Selection of Input Type and Input Range			Using programming software	
Calibration or Verification to Maintain Rated Accuracy			Not possible	

*1 The resistance (allowable conductor resistance) of the electrical leads to connect to the resistance thermometer is 10 Ω or less per wire.

*2 The arbitrary setting is a function that uses the digital resolution data by scaling it to arbitrary data (that arbitrarily sets the lower limit value and the upper limit value). The range setting (-32,768 to 32,767) is specified with data registers.

Example: When -5 V is input, 1,024 is displayed as long as the arbitrary setting is not configured, but -500 is displayed when the arbitrary setting is configured as upper limit value = 1,000 and lower limit value = -1,000, and this makes it easier to intuitively read the input voltage value.

When the digital resolution data is 12 bits and the input range is -10 to +10 V

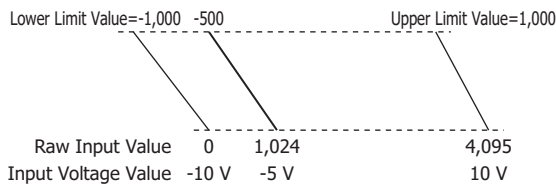

*3 Input data out of range is reflected in the status of the analog I/O module.

Input Internal Circuit

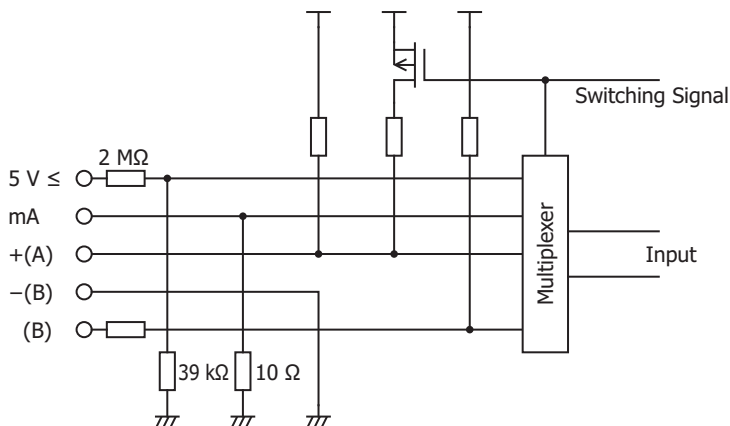

■ Output Specifications

Type No.		FC6A-F2M1, FC6A-F2M4	FC6A-F2MR1, FC6A-F2MR4	
Output Type and Output Range	Digital Output	Transistor protection source output (12V DC output)	Relay output	
	Analog Output	4 to 20 mA	—	
Load	Digital Output	Max 40 mA (12V DC)	—	
	Analog Output	550 Ω or higher	—	
	Relay Output	—	—	5 A 250V AC (resistive load)
				5 A 30V DC (resistive load)
				3 A 250V AC (inductive load $\cos\phi=0.4$)
3 A 30V DC (inductive load L/R=7 ms)				
Load Type	Resistive load	Resistive load/inductive load		
DA Conversion	Analog Output Settling Time	80 ms	—	
	Digital Output Delay Time	Turn OFF time: 10 ms Turn ON time: 5 ms	—	
	Total Output System Transfer Time	Analog output: Settling time + input sampling time (100 ms) Digital output/relay output: Output delay time + proportional cycle (1 to 120 s)		
Output Error	Maximum Error at 25°C	±0.5% of full scale		
	Temperature Coefficient	±0.01% of full scale/°C		
	Output Ripple	±0.2% or less of full scale		
	Overshoot	0%		
Data	Digital Resolution	1,000 steps (10 bits)		
	Input Type and Input Range	0.0016 mA (4 to 20 mA)		
	Monotonicity	Yes		
	Current Loop Open	Not detectable		
Noise Resistance	Maximum Temporary Deviation during Electrical Noise Tests	±4% or less of full scale		
	Recommended Cable for Noise Immunity	Current/voltage: Pair shielded cable		
	Crosstalk	1 LSB		
Isolation	Between Output and Power Circuit	Transformer isolated		
	Between Output and Internal Circuit	Photocoupler isolated		
Effect of Improper Output Connection		No damage		
Selection of Analog Output Signal Type		Using programming software		
Calibration or Verification to Maintain Rated Accuracy		Not possible		

Output Internal Circuit

FC6A-F2M1, FC6A-F2M4

(non-contact voltage output (to drive SSRs))

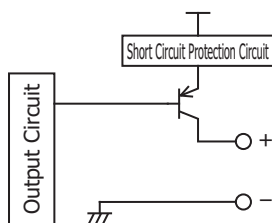

FC6A-F2M1, FC6A-F2M4

(current output)

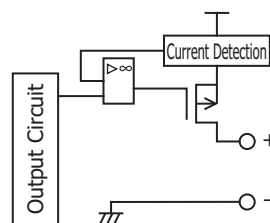

FC6A-F2MR1, FC6A-F2MR4

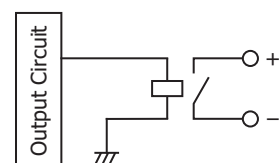

2: PRODUCT SPECIFICATIONS

Output Delay

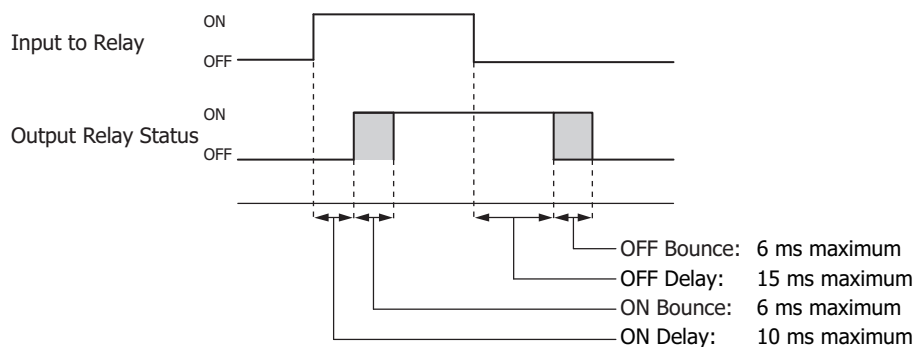

■ Program Performance

Item	Specifications
Time setting accuracy	Within $\pm 0.5\%$ of the set time
Progression time error after power interruption	6 minutes maximum

Terminal Arrangement and Wiring Examples



Caution

- When connecting the terminal, insert an IEC 60127-approved fuse suitable for the applied voltage and current draw at the position shown in the following diagram. This is required when equipment containing the MICROSmart is destined for Europe.
- Do not connect a thermocouple to a part with hazardous voltage (60V DC or peak 42.4V DC or higher part).
- Before turning on the power, always check the wiring. If the wiring is incorrect, the PID module may be damaged.
- When connecting stranded wire or multiple wires to a terminal block, always use a ferrule for the terminal block. For details, see "Recommended Ferrule List" on page 3-46.

■ FC6A-F2M1, FC6A-F2M4, FC6A-F2MR1, FC6A-F2MR4

Screw fastened type: FC6A-F2M1, FC6A-F2MR1

Applicable connector: FC6A-PMTC11PN02
FC6A-PMTC17PN02

Push-in type: FC6A-F2M4, FC6A-F2MR4

Applicable connector: FC6A-PMSC11PN02
FC6A-PMSC17PN02

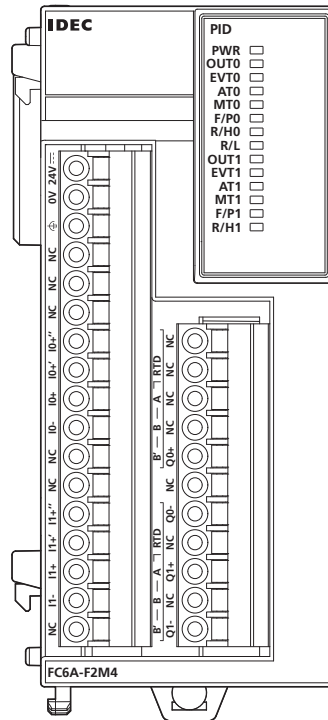
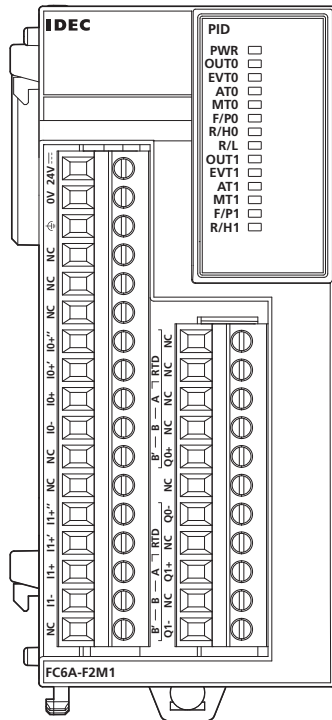

: Fuse

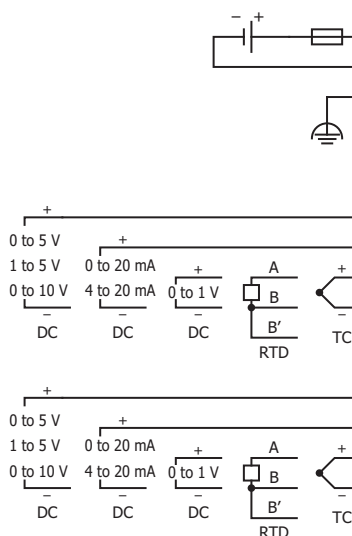

Terminal No.	I/O	
24V	24V DC	
0V	24V DC	
FE	24V DC	
NC	NC	
NC	NC	
NC	NC	
IO+''	IN 0	
IO+''	IN 0	
IO+	A	IN 0
IO-	B	IN 0
NC	B'	NC
NC	NC	
I1+''	IN 1	
I1+''	IN 1	
I1+	A	IN 1
I1-	B	IN 1
NC	B'	NC

DC : Voltage/current

RTD : Resistance Thermometer

TC : Thermocouple

: Load

: Analog Current Input Device

: Fuse

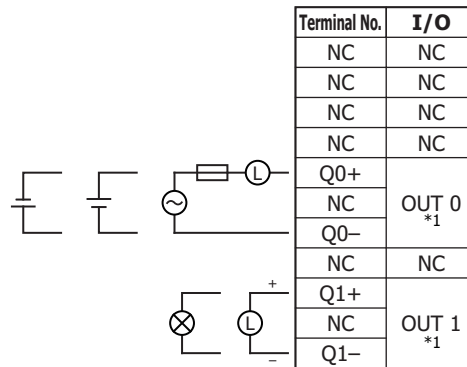

Terminal No.	I/O
NC	NC
NC	NC
NC	NC
NC	NC
Q0+	OUT 0 *1
NC	
Q0-	
NC	NC
Q1+	OUT 1 *1
NC	
Q1-	

*1 OUT0: Relay output and OUT1: Non-contact voltage/current output connection examples are shown. There are no models with both types of specifications.

2: PRODUCT SPECIFICATIONS

Precautions when Supplying Power to the PID Module

When the PID module and the CPU module are set to the same power supply, the PID module will be initialized for a maximum of approximately 5 seconds after the power is turned on and the CPU module is set to run, so the parameters will not be stable. Always enable control after the module status flag changes to "0001H" (operating normally).

Wiring PID Module Power and I/O Lines

Separate I/O lines (resistance thermometers in particular) from power lines as much as possible to reduce the effect of noise.

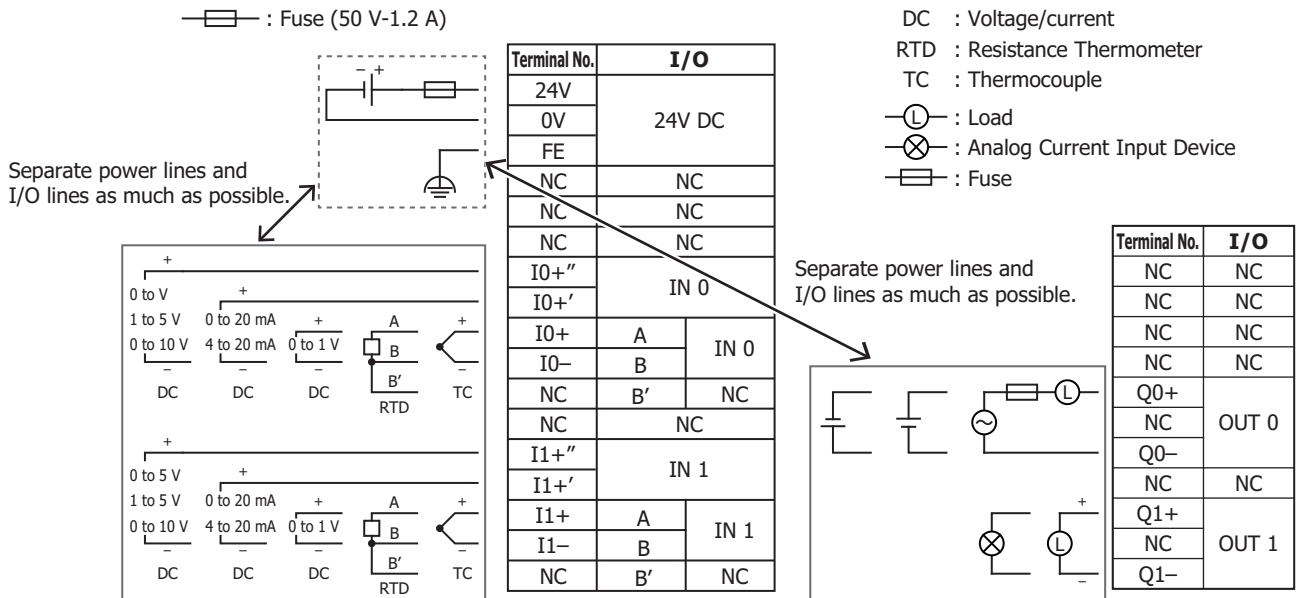

Communication Modules

The communication modules include the serial communications module that communicate with peripheral devices using RS-232C or RS-485 communications.

The communication modules are equipped with two serial ports, and RS-232C or RS-485 can be selected and used for each port. These modules support the maintenance communication function, user communication function, data link communication, and Modbus communication function.

Use the communication modules by connecting them to the CPU module. For details on the maximum number of communication modules that can be connected and slots to install those modules, see "Maximum Number of Modules and Slots to Install" on page 2-139. To use a communication module, it must be configured in the Module Configuration Editor. For detailed configuration methods, see "Module Configuration Editor" on page 12-1. For details on communication settings, see Chapter 3 "Communication Settings" in the "FC6A Series MICROSmart Communication Manual".

Note: Communication modules cannot be connected to the expansion interface remote slave module.

Part Names and Functions

FC6A-SIF52

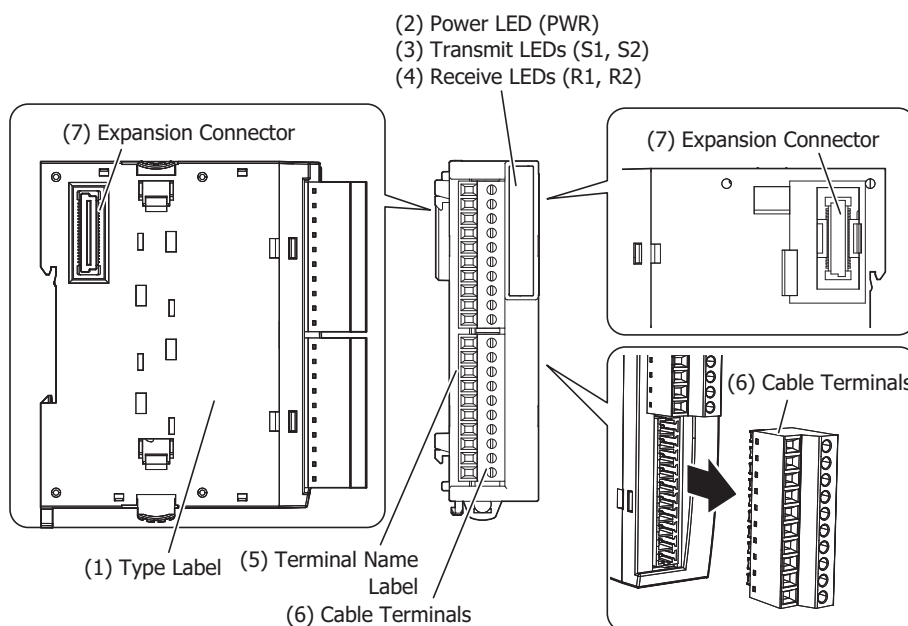

(1) Type Label

Indicates the communication module type number and specifications.

(2) Power LED (PWR)

This LED turns on when the power is supplied to the communication module.

(3) Transmit LEDs (S1, S2)

These LEDs turn on when data is being transmitted from the communication module.

(4) Receive LEDs (R1, R2)

These LEDs turn on when the communication module is receiving data.

(5) Terminal Name Label

Indicates terminal numbers.

(6) Cable Terminals

Wires for RS232C or RS485 communication are connected to these terminals.

(7) Expansion Connector

This connector is used to connect expansion modules and the CPU module.

2: PRODUCT SPECIFICATIONS

Model List

Module Type	Points	Type	Cable Terminal Type	Type No.
Communication module	2	Serial communication interface (RS-232C/RS-485)	Screw fastened type	FC6A-SIF52
			Push-in type	FC6A-SIF524

Note: A single port cannot be used as both RS-232C and RS-485 simultaneously.

Function Specifications

Type No.	FC6A-SIF52, FC6A-SIF524	
Terminal Arrangement	See "Terminal Arrangement and Wiring Examples" on page 2-141.	
Connector	Insertion/Removal Durability	100 times minimum
Internal Current Draw	5V DC	35 mA
	24V DC	35 mA
Weight (approx.)	FC6A-SIF52	110 g
	FC6A-SIF524	100 g

■ Communication Specifications

Type No.	FC6A-SIF52, FC6A-SIF524	
Points	2	
Electrical Characteristics	EIA RS-232C/EIA RS-485*1	
Maximum Communication Speed	115,200 bps	
Maintenance Communication	Yes	
User Communication	Yes	
Data Link Communication	Yes	
Modbus Master	Yes	
Modbus Slave	Yes	
Maximum Cable Length	15 m (RS232C)/1,200 m (RS485)	
Isolation between Internal Circuit	Between Communication Port and Internal Circuit	Photocoupler isolation
	Between Ports	Transformer isolation
Cable	Recommended Cable	RS-232C: 24 AWG shielded multicore cable RS-485: 24 AWG twisted-pair shielded cable

*1 Specify RS232C or RS485 in the WindLDR **Function Area Settings**. The combination of "Data Bits: 7 bits" and "Parity: None" cannot be set.

Communication Port Assignments

The communication ports are assigned to port 4, port 5, and so on in order from the ports closest to the CPU module.

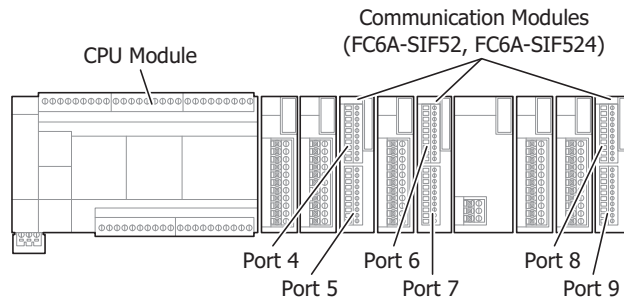

Maximum Number of Modules and Slots to Install

The maximum number of communication modules that can be connected to the CPU module depends on the CPU module. The following table gives the maximum number of communication modules that can be connected to each CPU module and slots to install those modules.

Module Type	Type No.	Maximum Number of Modules	Location			
			CPU Module		Expansion Interface Remote Slave Module	
			Basic Expansion Side	Expansion Interface Side	Basic Expansion Side	Expansion Interface Side
All-in-One CPU module	FC6A-C16R1AE FC6A-C16R4AE FC6A-C16R1CE FC6A-C16R4CE FC6A-C16K1CE FC6A-C16K4CE FC6A-C16P1CE FC6A-C16P4CE FC6A-C16R1DE FC6A-C16R4DE FC6A-C16K1DE FC6A-C16K4DE FC6A-C16P1DE FC6A-C16P4DE	3 modules*1	Yes	Yes	—*3	—*3
	FC6A-C24R1AE FC6A-C24R4AE FC6A-C24R1CE FC6A-C24R4CE FC6A-C24K1CE FC6A-C24K4CE FC6A-C24P1CE FC6A-C24P4CE					
	FC6A-C40R1AE FC6A-C40R4AE FC6A-C40R1CE FC6A-C40R4CE FC6A-C40K1CE FC6A-C40K4CE FC6A-C40P1CE FC6A-C40P4CE FC6A-C40R1DE FC6A-C40R4DE FC6A-C40K1DE FC6A-C40K4DE FC6A-C40P1DE FC6A-C40P4DE					
CAN J1939 All-in-One CPU module	FC6A-C40R1AEJ FC6A-C40R4AEJ FC6A-C40R1CEJ FC6A-C40R4CEJ FC6A-C40K1CEJ FC6A-C40K4CEJ FC6A-C40P1CEJ FC6A-C40P4CEJ FC6A-C40R1DEJ FC6A-C40R4DEJ FC6A-C40K1DEJ FC6A-C40K4DEJ FC6A-C40P1DEJ FC6A-C40P4DEJ	3 modules*1	Yes	Yes	—*3	—*3

2: PRODUCT SPECIFICATIONS

Module Type	Type No.	Maximum Number of Modules	Location			
			CPU Module		Expansion Interface Remote Slave Module	
			Basic Expansion Side	Expansion Interface Side	Basic Expansion Side	Expansion Interface Side
Plus CPU module	FC6A-D16R1CEE FC6A-D16R4CEE FC6A-D16K1CEE FC6A-D16K4CEE FC6A-D16P1CEE FC6A-D16P4CEE	7 modules + 8 modules*2	Yes	Yes	—	—
	FC6A-D32K3CEE FC6A-D32K4CEE FC6A-D32P3CEE FC6A-D32P4CEE					

*1 When the expansion interface module (expander) is used, communication modules can also be connected to the expansion interface side (right side).

*2 When the expansion interface module (expander) is used, a total of 15 communication modules, seven communication modules on the basic expansion side (left side) and additional eight communication modules on the expansion interface side (right side), can be connected to the CPU module. Communication modules cannot be connected to the expansion interface remote slave module.

*3 The expansion interface remote master/slave module cannot be connected to All-in-One CPU module or CAN J1939 All-in-One CPU module.

Terminal Arrangement and Wiring Examples

■ **FC6A-SIF52, FC6A-SIF54**

Screw fastened type: FC6A-SIF52

Applicable connector: FC6A-PMTC10PN02

Push-in type: FC6A-SIF54

Applicable connector: FC6A-PMSC10PN02

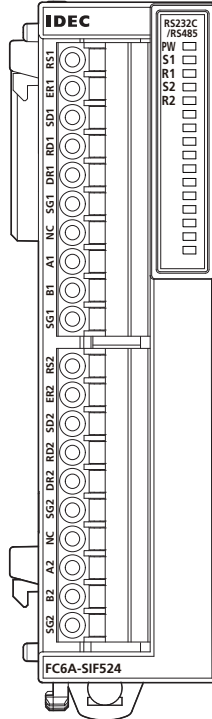
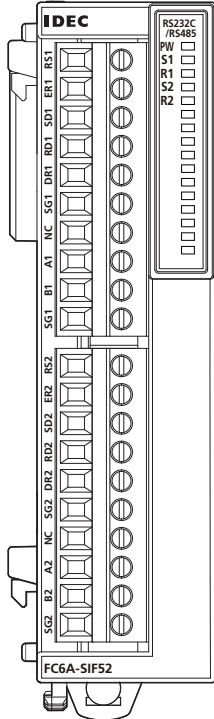

		Terminal No.	I/O	Signal Name
Upper Side Port	RS232C	RS1(RTS)	Output	Request to send
		ER1(DTR)	Output	Data terminal ready
		SD1(TxD)	Output	Transmitted data
		RD1(RxD)	Input	Received data
		DR1(DSR)	Input	Data set ready
		SG1	—	Signal ground
	RS485	NC	—	—
		A1	Input/output	Data A
		B1	Input/output	Data B
		SG1	—	Signal ground
Lower Side Port	RS232C	RS2(RTS)	Output	Request to send
		ER2(DTR)	Output	Data terminal ready
		SD2(TxD)	Output	Transmitted data
		RD2(RxD)	Input	Received data
		DR2(DSR)	Input	Data set ready
		SG2	—	Signal ground
	RS485	NC	—	—
		A2	Input/output	Data A
		B2	Input/output	Data B
		SG2	—	Signal ground

Wiring Example When Using Both Ports

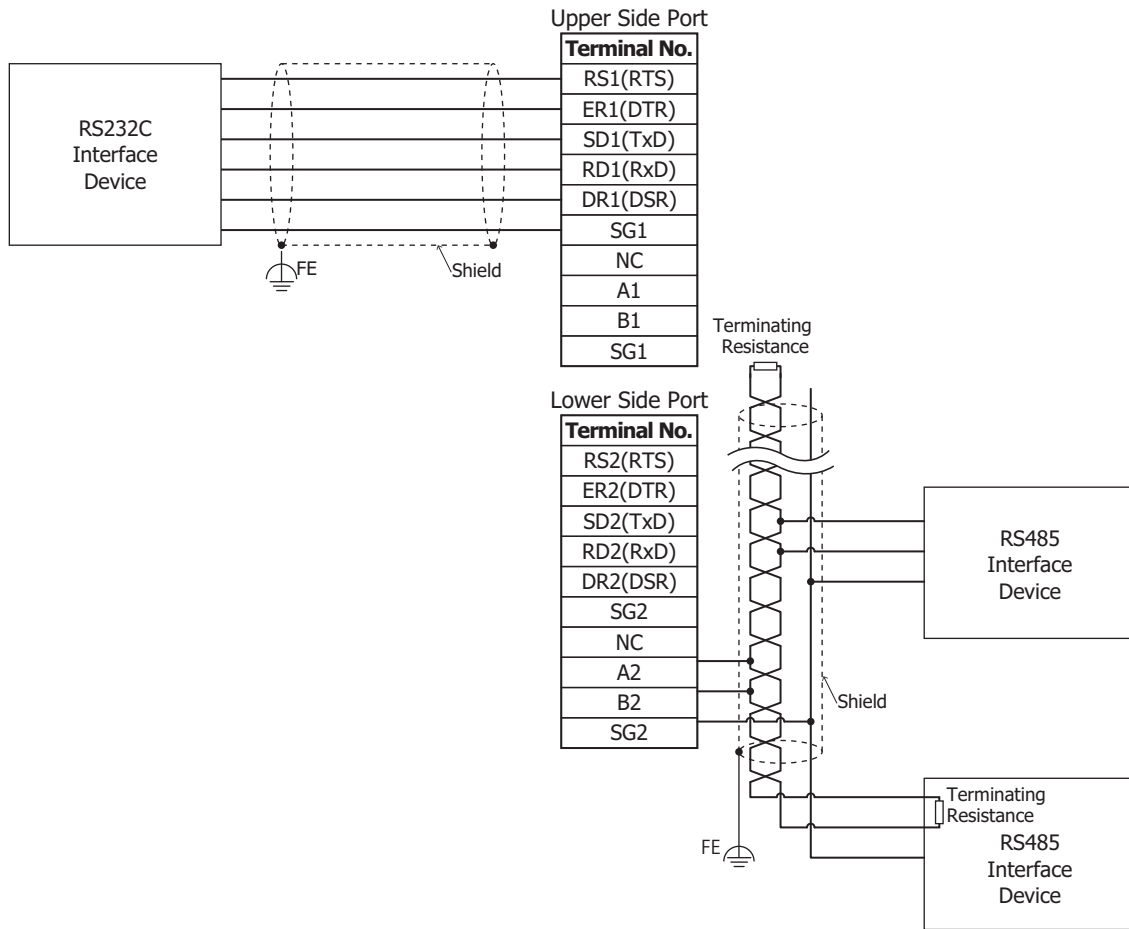

The serial communication module is equipped with two serial ports, and serial communication can be performed using both serial ports simultaneously. RS-232C or RS-485 can be selected and used for each port.

Above wiring example shows RS-232C communication with the upper side port and RS-485 communication with the lower side port.

Notes:

- A single port cannot be used as RS-232C and RS-485 simultaneously.
- When communication conditions are unstable, add terminating resistance matched to the characteristic impedance to both ends of the cable. Use resistance with a rating of 1/2 W or higher.

Expansion Interface Modules

The expansion interface modules are available as an expander that is added in between expansion modules to expand the number of connected modules and as remote modules (remote master and remote slave) that are daisy chained by Ethernet cables and allow expansion modules to be positioned away from the CPU module. Remote master/slave modules can be connected only to the Plus CPU module.

Expansion Interface Module (Expander)

The number of expansion modules that can be connected to the CPU module (basic expansion side) is seven modules, but additional eight expansion modules (expansion interface side, maximum 256 I/O points) can be connected by installing the expansion interface module (expander).

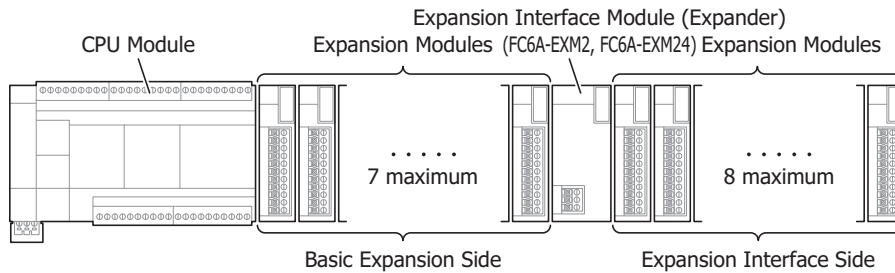

Notes:

- Only one expansion interface module (expander) can be connected to one CPU module.
- When using the expansion interface module (expander) together with expansion interface modules (remote master/slave) on the Plus CPU module, one expansion interface module (expander) can be connected per remote slave that is daisy chained to the remote master. For details, see "Expansion Interface Modules (Remote Master/Slave)" on page 2-146.
- The maximum number of modules that can be connected depends on the modules. For detailed restrictions when using the expansion interface module and connection examples, see "Connection Restrictions When Expanding the PLC" on page 3-37.

Parts Description

FC6A-EXM2

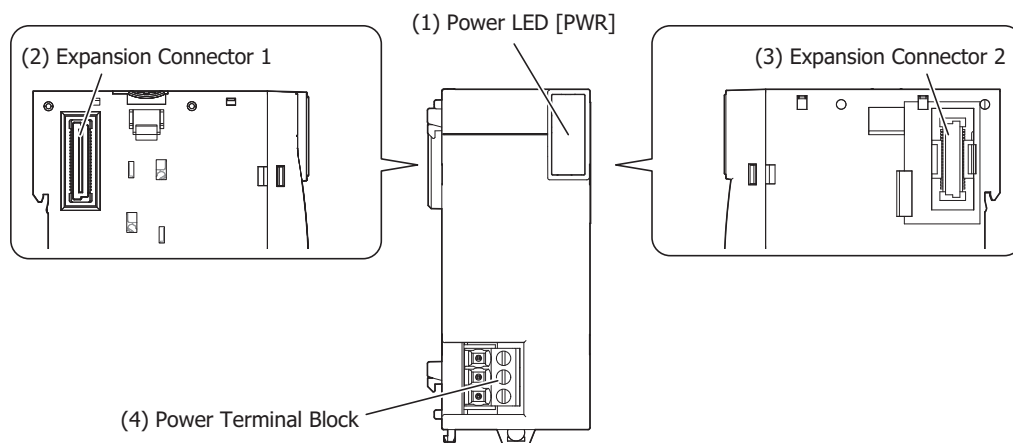

(1) Power LED [PWR]

This LED turns on when the power is supplied to the expansion interface module (expander).

(2) Expansion Connector 1

This connector is used to connect the expansion module on the basic expansion side.

(3) Expansion Connector 2

This connector is used to connect the expansion module on the expansion interface side.

(4) Power Terminal Block

These terminals supply 24V DC power to the expansion interface module (expander).

2: PRODUCT SPECIFICATIONS

Function Specifications

Type No.		FC6A-EXM2, FC6A-EXM24
Rated Operating Voltage		24V DC (supplied from external power)
Voltage Fluctuation Range		20.4 to 28.8V DC (including ripple)
Current Draw	Internal Power	CPU module side supply 20 mA (5V DC), 0 mA (24V DC)
	External Power	When maximum number of modules is connected*1 0.77 A (28.8V DC)
Maximum Power Consumption*1		19 W (28.8V DC)
I/O Expansion	Basic Expansion Side	Connectable CPU modules: All CPU modules Connectable expansion modules: Maximum of 7 modules*2
	Expansion Interface Side	Connectable expansion modules: Maximum of 8 modules
Allowable Momentary Power Interruption		10 ms or longer (when rated power supply voltage)
Isolation between Internal Circuit		Not isolated
Withstand Voltage		Between power and FE terminals: 500V AC, 1 minute
Insulation Resistance		Between power and FE terminals: 10 MΩ or higher (500V DC insulation resistance tester)
Inrush Current		35 A maximum
Ground		D-type ground (Class 3 ground)
Ground Wire		See "Connection Restrictions When Expanding the PLC" on page 3-37
Power Supply Wire		See "Connection Restrictions When Expanding the PLC" on page 3-37
Power Supply Connector	Insertion/Removal Durability	100 times minimum
Effect of Improper Power Supply Connection		Reverse polarity: No operation, no damage Improper voltage: Permanent damage may be caused Improper lead connection: Permanent damage may be caused
Weight		150 g

*1 The value when the expansion interface module (expander) + 8 expansion modules (expansion interface side) are used.

*2 The maximum is five modules when the expansion interface remote master module is connected to the Plus CPU module.

Terminal Arrangement and Wiring Examples

■ FC6A-EXM2, FC6A-EXM24

Screw fastened type: FC6A-EXM2

Applicable connector: FC6A-PMTB03PN02

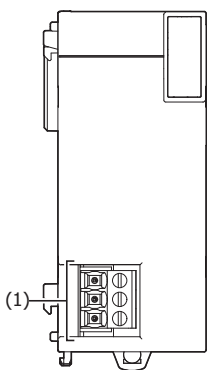

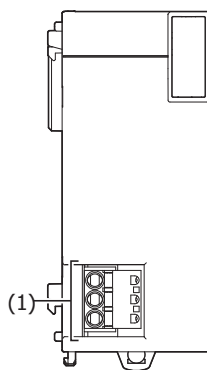

Push-in type: FC6A-EXM24

Applicable connector: FC6A-PMSB03PN02

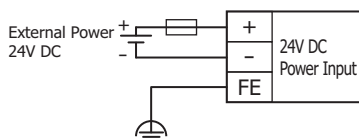

(1) Power supply terminals



 : Fuse

For wiring precautions, see "Power Supply and Power Supply Wiring" on page 3-20.

Power Supply Precautions

- When supplying the power to the CPU module and to the expansion interface module (expander) with different power supplies, turn the modules on and off in the order in the following table. An error may occur on the CPU module if the power on order or the power off order is mistaken.

Power Supply	Order
Power on	Turn on the expansion interface module (expander) and the CPU module at the same time, or in expansion interface module (expander) → CPU module order
Power off	Turn off the expansion interface module (expander) and the CPU module at the same time, or in CPU module → expansion interface module (expander) order

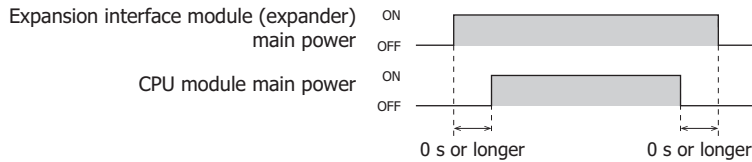

- When the CPU has suffered a power interruption and restarts, RUN/STOP follows the function area settings. When the expansion interface module (expander) has suffered a power interruption, the CPU maintains its RUN/STOP status regardless of that power interruption. The other cartridges and the HMI module operate regardless of whether or not the expansion interface module is powered. This section describes items that are particular affected by a power interruption of the expansion interface module.

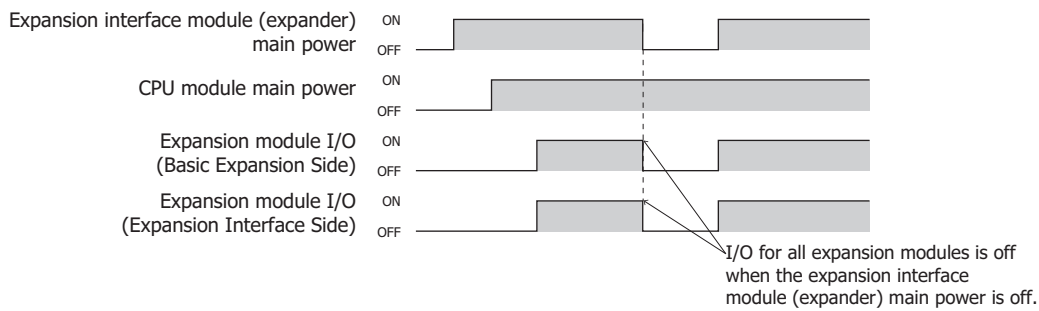

- If the expansion interface module (expander) main power supply is on and the CPU module main power supply is off, the expansion modules on the expansion interface side are set to the reset status. Please note that during the reset status, the analog I/O module and PID module LED indicators are on. This is not a malfunction.

Expansion Interface Modules (Remote Master/Slave)

The Plus CPU module can be expanded with up to a maximum of 63 modules (I/O points: maximum 2,016 points) using expansion interface modules (remote master/slave). The expansion interface modules (remote master/slave) are the remote master which connects to the expansion connector of the Plus CPU module and the remote slave which connects to expansion modules that are positioned away from the CPU module.

The expansion interface remote master module can be connected only to the basic expansion side of the Plus CPU module. At this time, the maximum number of expansion modules (basic expansion side) that can be connected to the remote master is five modules, but additional eight expansion modules (expansion interface side) can be connected by installing the expansion interface module (expander).

Expansion interface remote slave modules are daisy chained to the remote master using Ethernet cables.

The group of expansion modules that are connected to the expansion connectors and communication connectors of the Plus CPU module and expansion interface remote slave modules are called as nodes. As illustrated below, the first node that includes the Plus CPU module is called node 0, and the nodes containing remote slaves are called node 1, node 2, and up to node 10 in order from those closest to node 0. The maximum number of nodes is 11, from node 0 to node 10.

The maximum number of expansion modules (basic expansion side) that can be connected to the remote slaves is seven modules, but additional eight expansion modules (expansion interface side) can be connected by installing the expansion interface module (expander).

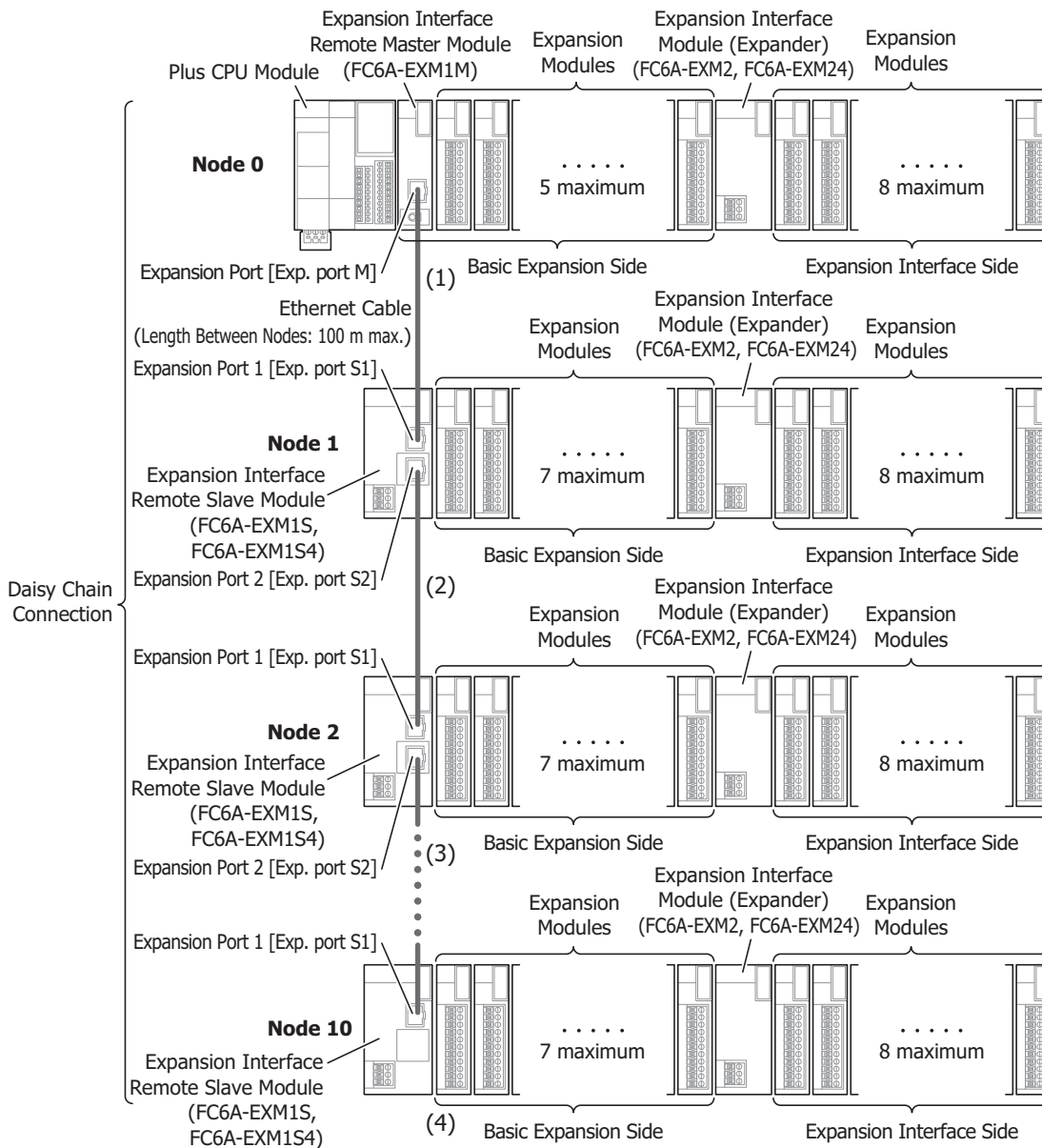

- (1) For the remote master, connect expansion port [Exp. port M] to expansion port 1 [Exp. port S1] on the remote slave installed as node 1 using an Ethernet cable.
- (2) To install node 2, connect expansion port 2 [Exp. port S2] on the remote slave of node 1 to expansion port 1 [Exp. port S1] on the remote slave installed as node 2 using an Ethernet cable.
- (3) To add more nodes, follow the same procedure and connect expansion port 2 [Exp. port S2] on the remote slave of upstream node n to expansion port 1 [Exp. port S1] on the remote slave of downstream node n+1 using an Ethernet cable. (n = 3 to 9)
- (4) A maximum of 10 nodes can be used.
Do not connect an Ethernet cable to expansion port 2 [Exp. port S2] of the remote slave installed as the last node.

Notes:

- The expansion interface remote master module can be connected only to the Plus CPU module and used on the basic expansion side.
- A maximum of 10 expansion interface remote slave modules can be used within a single daisy chain connection setup.
- Only one expansion interface module (expander) can be connected to each node.
- The only connection that is supported between the remote master and remote slaves is a daisy chain connection. Star connections and tree connections are not supported.
- The maximum number of expansion modules that can be connected is 63 modules, but the maximum number of modules that can be connected depends on the connected module. For details on restrictions when using expansion interface modules (remote master/slave), see "Connection Restrictions When Expanding the PLC" on page 3-37.
- Any devices other than the expansion interface remote master/slave modules do not operate even if they are connected to the expansion port [Exp. port M] on the expansion interface remote master module or the expansion port 1 [Exp. port S1] or the expansion port 2 [Exp. port S2] on the expansion interface remote slave module. If connected with an Ethernet cable, the expansion interface remote master module does not recognize the expansion interface remote slave modules.

Part Names and Functions

■ Expansion Interface Remote Master Module

FC6A-EXM1M

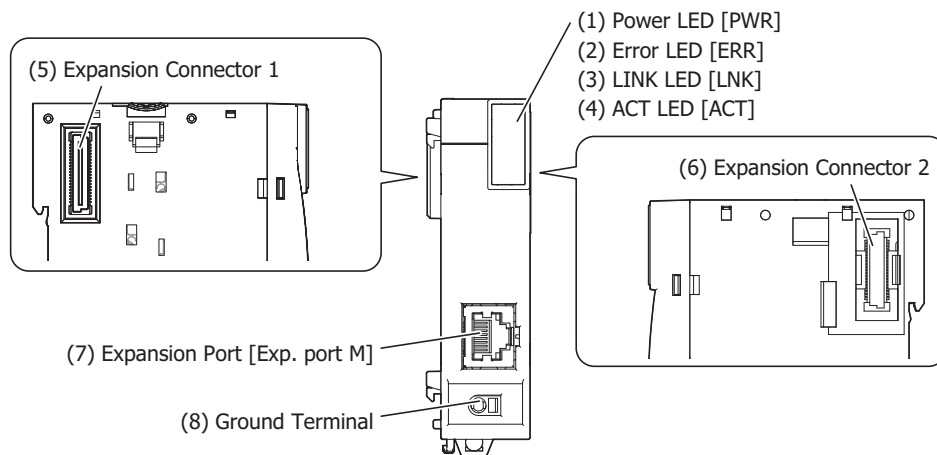

(1) Power LED [PWR]

This LED turns on when the power is supplied to the expansion interface remote master module from the internal power supply of the Plus CPU module.

(2) Error LED [ERR]

This LED turns on when the following errors occur in the expansion interface remote master module.

- When the cable breaks or the power supply to the expansion interface remote slave modules is turned off (LINK not established state continues for 10 seconds or longer)
- When there is an Ethernet communication error (when LINK is established and data is not normally received for a fixed amount of time or longer even when one expansion interface remote slave module is connected)
- When there is an internal circuit error
- When there is a CPU module error

(3) LINK LED [LNK]

This LED turns on when an expansion interface remote slave module is connected using an Ethernet cable.

2: PRODUCT SPECIFICATIONS

(4) ACT LED [ACT]

This LED flashes when the module is communicating with the expansion interface remote slave module connected using an Ethernet cable.

(5) Expansion Connector 1

This connector is used to connect the Plus CPU module or an expansion module.

(6) Expansion Connector 2

This connector is used to connect an expansion module.

(7) Expansion Port [Exp. port M]

This port is used to connect an expansion interface remote slave module using an Ethernet cable.

(8) Ground Terminal

The functional ground terminal.

■ Expansion Interface Remote Slave Module

FC6A-EXM1S

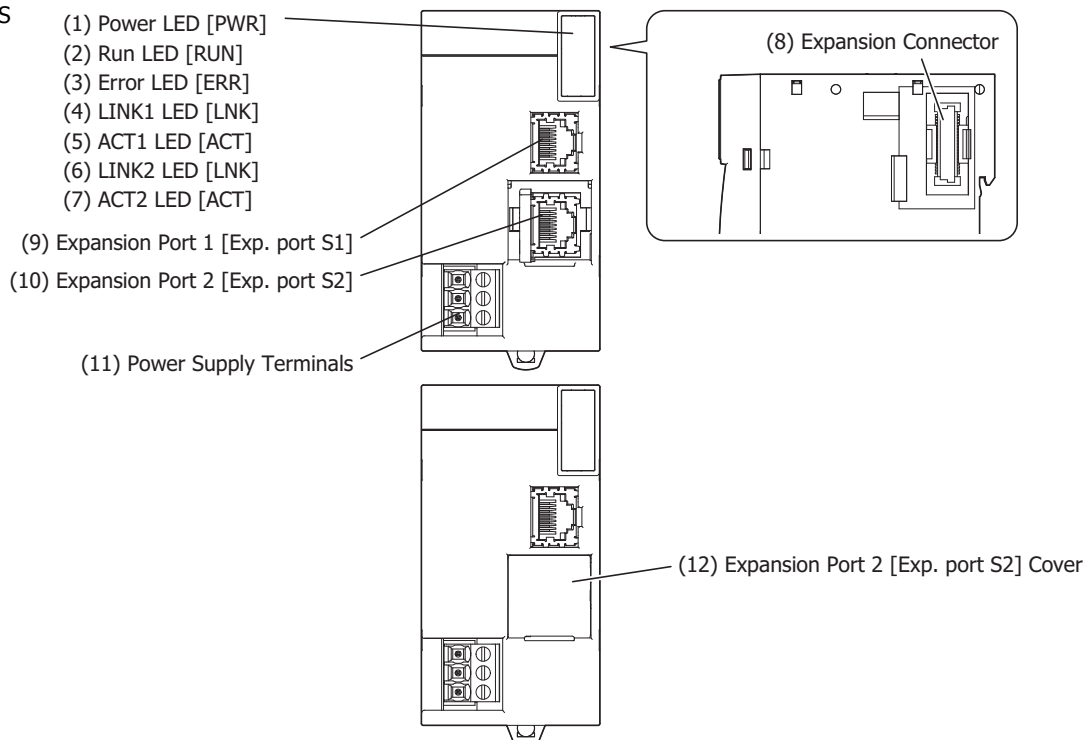

(1) Power LED [PWR]

This LED turns on when the power is supplied to the expansion interface remote slave module.

(2) Run LED [RUN]

This LED turns on when the expansion interface remote slave module is operating.

(3) Error LED [ERR]

This LED turns on when the following errors occur in the expansion interface remote slave module.

- When the cable breaks (data is not normally received for 10 seconds or longer on expansion port 1 [Exp. port S1])
- When the following occur for a connected expansion module:
 - An unsupported module was connected.
 - Exceeded 15 modules.
 - Exceeded seven modules on the basic expansion side.
 - Exceeded eight modules on the expansion interface side.
 - Initialization error

(4) LINK1 LED [LNK]

This LED turns on when the expansion interface remote master module or upstream expansion interface remote slave module is connected to expansion port 1 [Exp. port S1] using an Ethernet cable.

(5) ACT1 LED [ACT]

When the LINK1 LED is on, this LED flashes when the module is communicating with the expansion interface remote master module or upstream expansion interface remote slave module.

(6) LINK2 LED [LNK]

This LED turns on when the downstream expansion interface remote slave module is connected to expansion port 2 [Exp. port S2] using an Ethernet cable.

(7) ACT2 LED [ACT]

When the LINK2 LED is on, this LED flashes when the module is communicating with the downstream expansion interface remote slave module.

(8) Expansion Connector

This connector is used to connect an expansion module.

(9) Expansion Port 1 [Exp. port S1]

This port is used to connect the expansion interface remote master module or upstream expansion interface remote slave module to the module using an Ethernet cable.

(10) Expansion Port 2 [Exp. port S2]

This port is used to connect the downstream expansion interface remote slave module to the module using an Ethernet cable.

(11) Power Supply Terminals

These terminals supply 24V DC power to the expansion interface remote slave module.

(12) Expansion Port 2 [Exp. port S2] Cover

A removable cover that protects expansion port 2 [Exp. port S2]. When using expansion port 2 [Exp. port S2], remove the expansion port 2 [Exp. port S2] cover.

Expansion Modules That Can Be Connected to an Expansion Interface Remote Slave Module

Module Type	Connectable to Expansion Interface Remote Slave Module
Digital I/O module	Yes
Analog I/O module	Yes
PID module	Yes
Communication module	—
Expansion interface module (expander)	Yes
Expansion interface remote master module	—

Function Specifications

Type No.	FC6A-EXM1M (Expansion interface remote master module)	FC6A-EXM1S, FC6A-EXM1S4 (Expansion interface remote slave module)
Rated Operating Voltage	Internal power: 5V DC (supplied from CPU module)	External power: 24V DC
Voltage Fluctuation Range	—	20.4 to 28.8V DC (including ripple)
Current Draw	Internal Power	75 mA supplied from CPU module (5V DC)
	External Power	—
Allowable Momentary Power Interruption	—	10 ms or longer (when rated power supply voltage)
Isolation between Internal Circuit	Not isolated	Not isolated
Withstand Voltage	—	Between power and FE terminals: 500V AC, 1 minute
Insulation Resistance	—	Between power and FE terminals: 10 MΩ or higher (500V DC insulation resistance tester)
Inrush Current	—	35 A maximum

2: PRODUCT SPECIFICATIONS

Type No.	FC6A-EXM1M (Expansion interface remote master module)	FC6A-EXM1S, FC6A-EXM1S4 (Expansion interface remote slave module)
Ground	D-type ground (Class 3 ground)	
Ground Wire	See "Recommended Ferrule List" on page 3-46.	
Power Supply Wire	—	See "Recommended Ferrule List" on page 3-46.
Power Supply Connector	—	100 times minimum
Effect of Improper Power Supply Connection	—	Reverse polarity: No operation, no damage
	—	Improper voltage: Permanent damage may be caused
	—	Improper lead connection: Permanent damage may be caused
Weight (approx.)	80 g	165 g

Communication Port Specifications (Exp. port M, Exp. port S1, Exp. port S2)

Communication Type	IEEE 802.3-compliant 100BASE-TX (Auto MDI/MDI-X supported)
Communication Protocol	Dedicated communications (the modules cannot be connected to other Ethernet network)
Connector	RJ45
Cable	CAT 5 or higher, STP
Maximum Cable Length	100 m
Isolation between Internal Circuit	Pulse transformer isolated

Terminal Arrangement and Wiring Examples

■ FC6A-EXM1S, FC6A-EXM1S4 (Expansion Interface Remote Slave Module)

Screw fastened type: FC6A-EXM1S

Applicable connector: FC6A-PMTB03PN02

Push-in type: FC6A-EXM1S4

Applicable connector: FC6A-PMSB03PN02

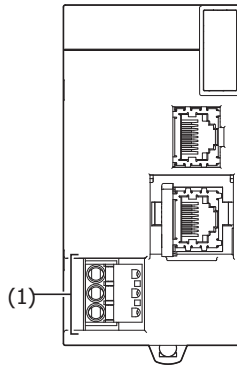
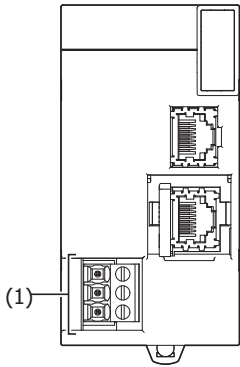

(1) Power supply terminals

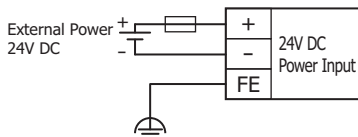

 : Fuse

For wiring precautions, see "Power Supply and Power Supply Wiring" on page 3-20.

Power Supply Precautions

When supplying the power to the CPU module, expansion interface remote slave modules, and expansion interface modules (expander) with separate power supplies, turn the modules on and off in the order given in the following table. An error will occur on the CPU module if the order to turn the power supply on and off is wrong.

Power Supply	Order
ON	Expansion interface module (expander) -> Expansion interface remote slave module -> CPU module order
OFF	CPU module -> Expansion interface remote slave module -> Expansion interface module (expander) order

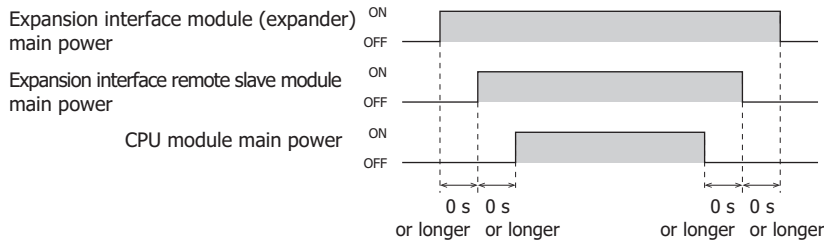

If the order to turn on the power supply is wrong, the expansion interface modules (remote master/slave) along with the connected expansion modules can be initialized by turning on M8320 (Initialize Expansion Interface Remote Master/Slave Modules).

Programming Example

The following program shows how to recover the operation of the system using three expansion interface remote slave modules when the power supply to those modules are turned on in a wrong order.

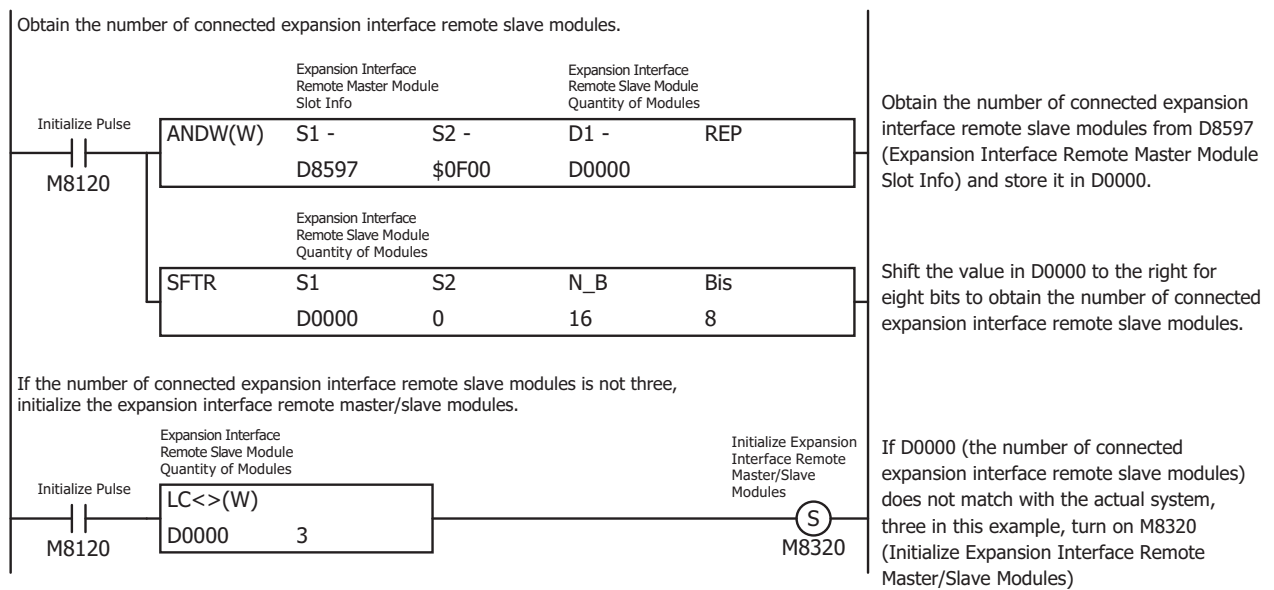

2: PRODUCT SPECIFICATIONS

Maximum I/O Points When Using Expansion Interface Modules (Remote Master/Slave)

The following table gives the number of digital I/O points and analog I/O points when expansion interface modules (remote master/slave) are connected to the Plus CPU module and the maximum number of expansion modules and cartridges are connected to the system.

I/O		Maximum No. of I/O Points
Digital I/O	Input	2,044
	Output	2,044
Analog I/O	Input	511
	Output	258

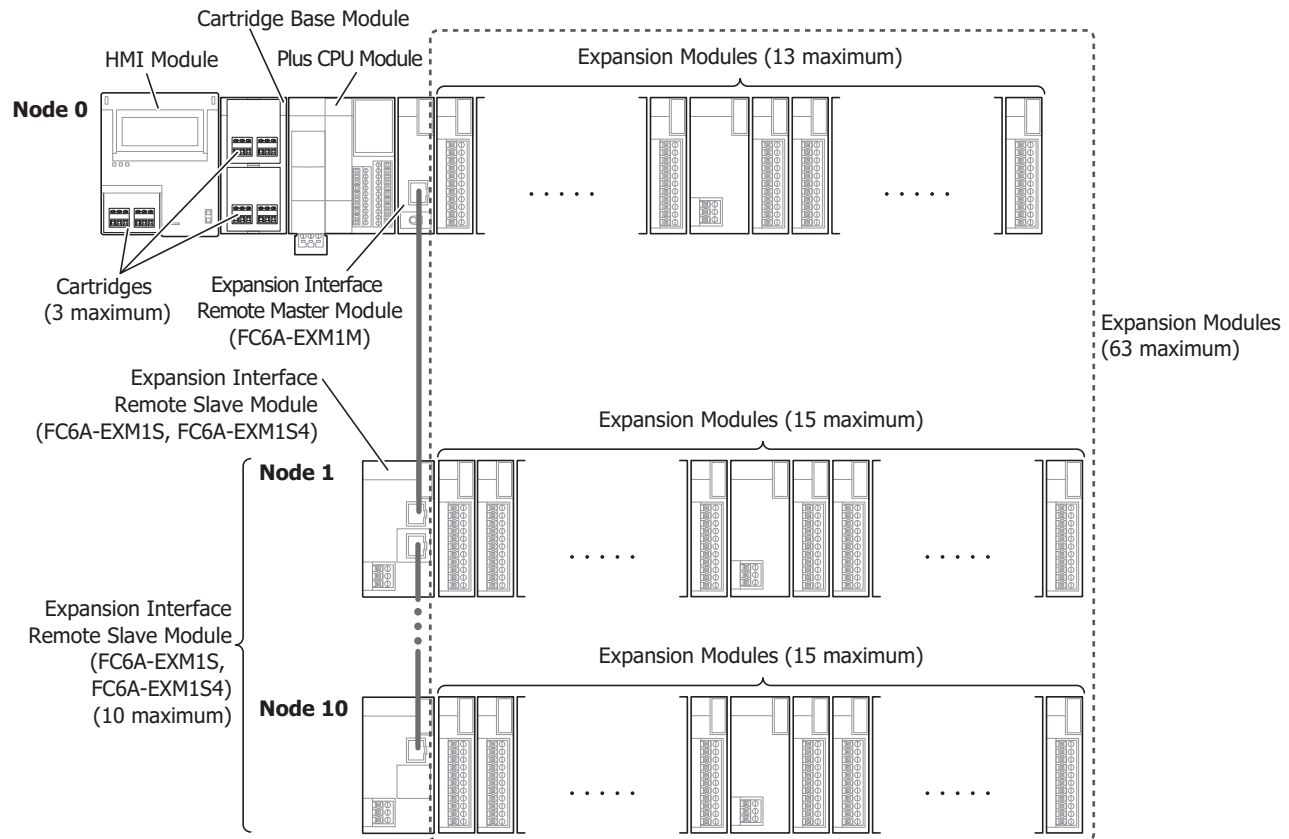

Maximum number of expansion modules: 63

Maximum number of expansion cartridges: 3

Notes:

- I/O refresh time of the expansion interface remote master/slave modules is stored in D8618 (Refresh Time of Expansion Interface Remote Master/Slave Modules Current Value) and D8619 (Refresh Time of Expansion Interface Remote Master/Slave Modules Maximum Value). When the outputs status are changed in a shorter time than the I/O refresh time of the expansion interface remote master/slave modules, the outputs status may be reflected to the actual outputs. Make sure that the outputs are controlled in a longer time than the I/O refresh time of the expansion interface remote master/slave modules.
- The expansion interface master/slave modules cannot be connected over the Ethernet switch.

Calculation Method of I/O Data Refresh Time

When expansion modules are used with the CPU module, an approximate value for the I/O data refresh time can be calculated with the following equations.

Use the I/O data refresh time obtained with the following equations as a rough estimate.

■ **When Not Using an Expansion Interface Module (FC6A-EXM2, FC6A-EXM24, FC6A-EXM1M, FC6A-EXM1S, or FC6A-EXM1S4)**

$$\text{I/O data refresh time} = \underbrace{(\quad) \text{ module(s)} \times 0.04 \text{ ms}}_{\text{Digital I/O module}} + \underbrace{(\quad) \text{ module(s)} \times 0.17 \text{ ms}}_{\text{Analog I/O module}} + \underbrace{(\quad) \text{ module(s)} \times 0.34 \text{ ms}}_{\text{PID module}} + \underbrace{(\quad) \text{ module(s)} \times 1.09 \text{ ms}}_{\text{Communication module}} + \text{scan time}$$

Example:

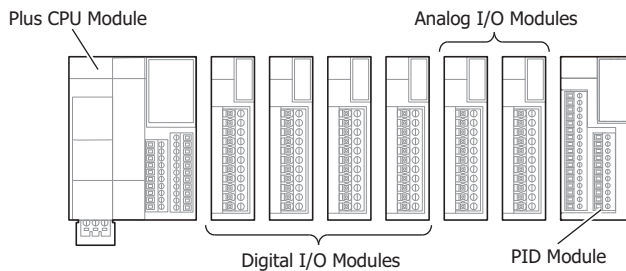

$$\begin{aligned} \text{I/O data refresh time} &= 4 \times 0.04 \text{ ms} + 2 \times 0.17 \text{ ms} + 1 \times 0.34 \text{ ms} + 0 \times 1.09 \text{ ms} + \text{scan time} \\ &= 0.84 \text{ ms} + \text{scan time} \end{aligned}$$

■ **When Using an Expansion Interface Module (Expander) (FC6A-EXM2, FC6A-EXM24)**

$$\text{I/O data refresh time} = \underbrace{(\quad) \text{ module(s)} \times 0.08 \text{ ms}}_{\text{Digital I/O module}} + \underbrace{(\quad) \text{ module(s)} \times 0.29 \text{ ms}}_{\text{Analog I/O module}} + \underbrace{(\quad) \text{ module(s)} \times 0.58 \text{ ms}}_{\text{PID module}} + \underbrace{(\quad) \text{ module(s)} \times 1.09 \text{ ms}}_{\text{Communication module}} + \text{scan time}$$

Example:

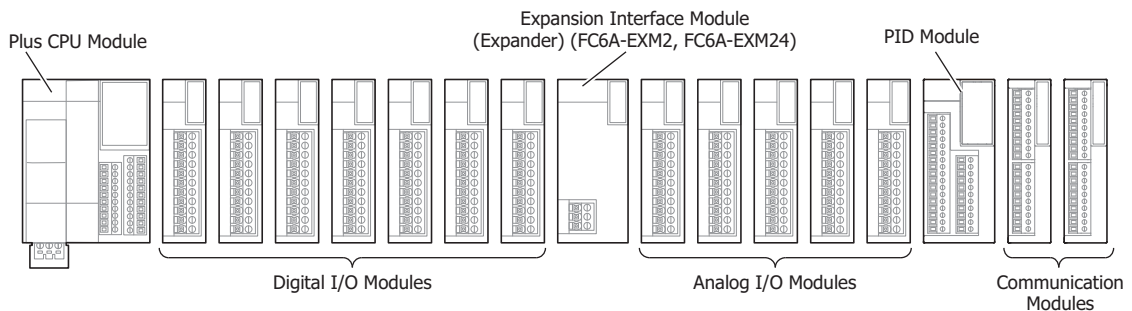

$$\begin{aligned} \text{I/O data refresh time} &= 7 \times 0.08 \text{ ms} + 5 \times 0.29 \text{ ms} + 1 \times 0.58 \text{ ms} + 2 \times 1.09 \text{ ms} + \text{scan time} \\ &= 4.77 \text{ ms} + \text{scan time} \end{aligned}$$

2: PRODUCT SPECIFICATIONS

■ When Using an Expansion Interface Module (Remote Master/Slave) (FC6A-EXM1M, FC6A-EXM1S, or FC6A-EXM1S4)

1. I/O data refresh time of node 0

$$\begin{aligned}
 \text{I/O data refresh time} = & \underbrace{(\quad) \text{ module(s)} \times 0.34 \text{ ms}}_{\substack{\text{FC6A-EXM1M} \\ \text{FC6A-EXM1S} \\ \text{FC6A-EXM1S4}}} + \underbrace{(\quad) \text{ module(s)} \times 0.04 \text{ ms}}_{\text{Digital I/O module}} + \underbrace{(\quad) \text{ module(s)} \times 0.17 \text{ ms}}_{\text{Analog I/O module}} + \underbrace{(\quad) \text{ module(s)} \times 0.34 \text{ ms}}_{\text{PID module}} + \underbrace{(\quad) \text{ module(s)} \times 1.09 \text{ ms}}_{\text{Communication module}} \\
 & \hspace{15em} \underbrace{\hspace{15em}}_{\text{Expansion modules of node 0}} \\
 & + \underbrace{(\quad) \text{ module(s)} \times 0.04 \text{ ms}}_{\text{Digital I/O module}} + \underbrace{(\quad) \text{ module(s)} \times 0.17 \text{ ms}}_{\text{Analog I/O module}} + \underbrace{(\quad) \text{ module(s)} \times 0.34 \text{ ms}}_{\text{PID module}} + \text{scan time} \\
 & \hspace{15em} \underbrace{\hspace{15em}}_{\text{Expansion modules of node 1 and subsequent nodes}}
 \end{aligned}$$

2. I/O data refresh time of node 1 and subsequent nodes

$$\begin{aligned}
 \text{I/O data refresh time} = & \text{I/O data refresh time of node 0 (1.)} + \{ \underbrace{(\quad) \text{ module(s)} \times 1.2 \text{ ms}}_{\substack{\text{FC6A-EXM1S} \\ \text{FC6A-EXM1S4}}} + \underbrace{(\quad) \text{ module(s)} \times 0.3 \text{ ms}}_{\substack{\text{Analog I/O module} \\ \text{PID module}}} \} \\
 & \hspace{15em} \underbrace{\hspace{15em}}_{\text{Expansion modules of node 1 and subsequent nodes}} \\
 & + \underbrace{(\quad) \text{ module(s)} \times 0.04 \text{ ms}}_{\text{Digital I/O module}} + \underbrace{(\quad) \text{ module(s)} \times 0.17 \text{ ms}}_{\text{Analog I/O module}} + \underbrace{(\quad) \text{ module(s)} \times 0.34 \text{ ms}}_{\text{PID module}} + 5 \text{ ms} \} \div 2 + \text{scan time} \\
 & \hspace{15em} \underbrace{\hspace{15em}}_{\text{Expansion modules of node 1 and subsequent nodes}}
 \end{aligned}$$

Examples:

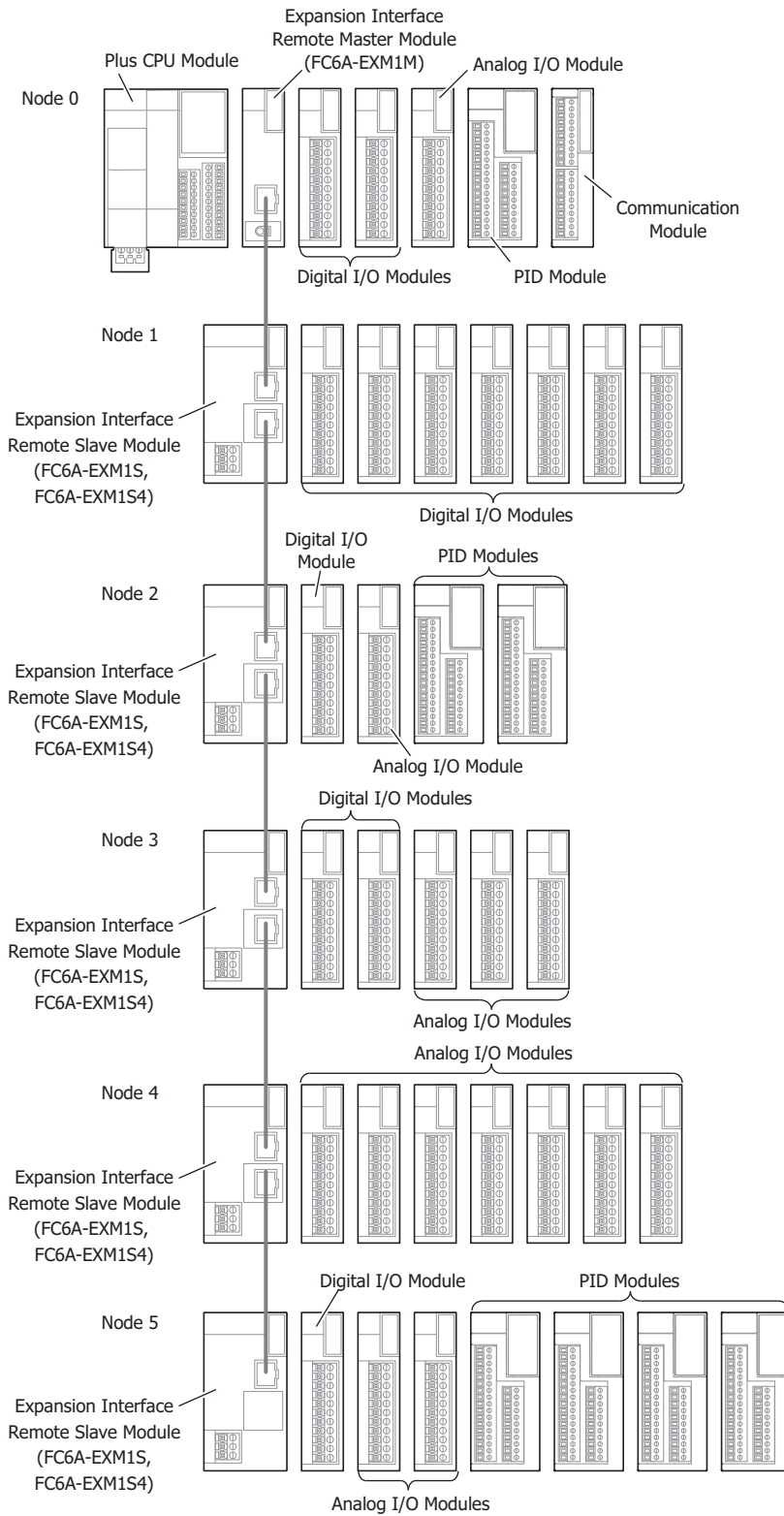

2: PRODUCT SPECIFICATIONS

1. I/O data refresh time of node 0

$$\begin{aligned}\text{I/O data refresh time} &= 6 \times 0.34 \text{ ms} + 2 \times 0.04 \text{ ms} + 1 \times 0.17 \text{ ms} + 1 \times 0.34 \text{ ms} + 1 \times 1.09 \text{ ms} \\ &\quad + 11 \times 0.04 \text{ ms} + 13 \times 0.17 \text{ ms} + 6 \times 0.34 \text{ ms} + \text{scan time} \\ &= 8.41 \text{ ms} + \text{scan time}\end{aligned}$$

2. I/O data refresh time of node 1 and subsequent nodes

$$\begin{aligned}\text{I/O data refresh time} &= 8.41 \text{ ms} + \{ 5 \times 1.2 \text{ ms} + 19 \times 0.3 \text{ ms} + 11 \times 0.04 \text{ ms} + 13 \times 0.17 \text{ ms} + 6 \times 0.34 \text{ ms} + 5 \text{ ms} \} \div 2 \\ &\quad + \text{scan time} \\ &= 19.11 \text{ ms} + \text{scan time}\end{aligned}$$

■ When Using an Expansion Interface Module (FC6A-EXM2, FC6A-EXM24, FC6A-EXM1S, FC6A-EXM1S4, or FC6A-EXM1)

1. I/O data refresh time of node 0

$$\begin{aligned}
 \text{I/O data refresh time} &= \underbrace{(\quad) \text{ module(s)} \times 0.68 \text{ ms}}_{\substack{\text{FC6A-EXM1M} \\ \text{FC6A-EXM1S} \\ \text{FC6A-EXM1S4}}} + \underbrace{(\quad) \text{ module(s)} \times 0.08 \text{ ms}}_{\text{Digital I/O module}} + \underbrace{(\quad) \text{ module(s)} \times 0.29 \text{ ms}}_{\text{Analog I/O module}} + \underbrace{(\quad) \text{ module(s)} \times 0.58 \text{ ms}}_{\text{PID module}} + \underbrace{(\quad) \text{ module(s)} \times 1.09 \text{ ms}}_{\text{Communication module}} \\
 &\hspace{15em} \underbrace{\hspace{15em}}_{\text{Expansion modules of node 0}} \\
 &+ \underbrace{(\quad) \text{ module(s)} \times 0.08 \text{ ms}}_{\text{Digital I/O module}} + \underbrace{(\quad) \text{ module(s)} \times 0.29 \text{ ms}}_{\text{Analog I/O module}} + \underbrace{(\quad) \text{ module(s)} \times 0.58 \text{ ms}}_{\text{PID module}} + \text{scan time} \\
 &\hspace{15em} \underbrace{\hspace{15em}}_{\text{Expansion modules of node 1 and subsequent nodes}}
 \end{aligned}$$

2. I/O data refresh time of node 1 and subsequent nodes

$$\begin{aligned}
 \text{I/O data refresh time} &= \text{I/O data refresh time of node 0 (1.)} + \{ \underbrace{(\quad) \text{ module(s)} \times 1.2 \text{ ms}}_{\substack{\text{FC6A-EXM1S} \\ \text{FC6A-EXM1S4}}} + \underbrace{(\quad) \text{ module(s)} \times 0.3 \text{ ms}}_{\substack{\text{Analog I/O module} \\ \text{PID module}}} \} \\
 &\hspace{15em} \underbrace{\hspace{15em}}_{\text{Expansion modules of node 1 and subsequent nodes}} \\
 &+ \underbrace{(\quad) \text{ module(s)} \times 0.04 \text{ ms}}_{\text{Digital I/O module}} + \underbrace{(\quad) \text{ module(s)} \times 0.17 \text{ ms}}_{\text{Analog I/O module}} + \underbrace{(\quad) \text{ module(s)} \times 0.34 \text{ ms}}_{\text{PID module}} \\
 &\hspace{15em} \underbrace{\hspace{15em}}_{\text{Expansion modules of node 1 and subsequent nodes that are not using the FC6A-EXM2, FC6A-EXM24}} \\
 &+ \underbrace{(\quad) \text{ module(s)} \times 0.08 \text{ ms}}_{\text{Digital I/O module}} + \underbrace{(\quad) \text{ module(s)} \times 0.29 \text{ ms}}_{\text{Analog I/O module}} + \underbrace{(\quad) \text{ module(s)} \times 0.58 \text{ ms}}_{\text{PID module}} + 5 \text{ ms} \} \div 2 + \text{scan time} \\
 &\hspace{15em} \underbrace{\hspace{15em}}_{\text{Expansion modules of node 1 and subsequent nodes that are using the FC6A-EXM2, FC6A-EXM24}}
 \end{aligned}$$

Examples:

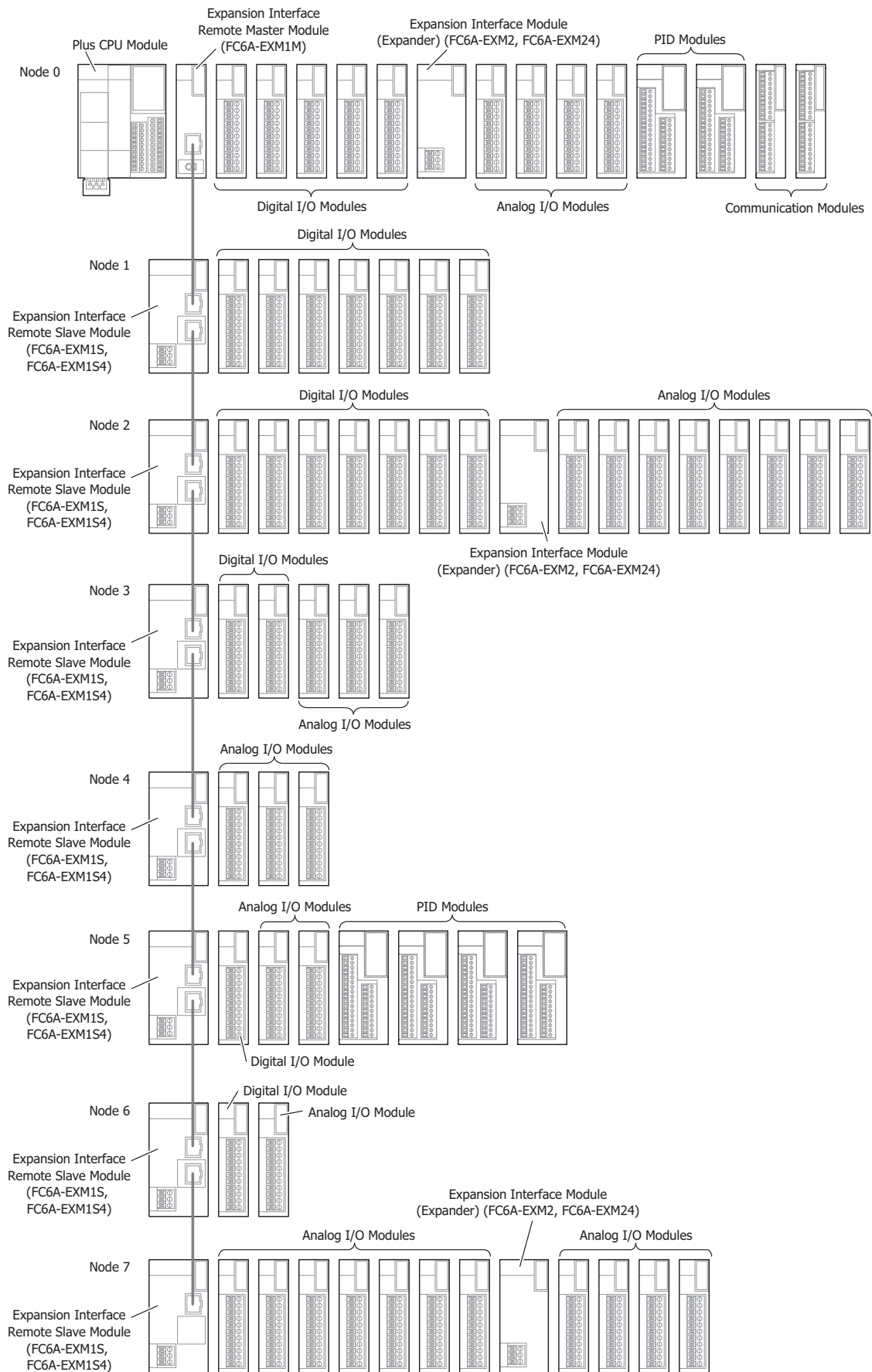

1. I/O data refresh time of node 0

$$\begin{aligned}\mathbf{I/O\ data\ refresh\ time} &= 8 \times 0.68\ \text{ms} + 5 \times 0.08\ \text{ms} + 4 \times 0.29\ \text{ms} + 2 \times 0.58\ \text{ms} + 2 \times 1.09\ \text{ms} + 18 \times 0.08\ \text{ms} + 28 \times 0.29\ \text{ms} \\ &\quad + 4 \times 0.58\ \text{ms} + \text{scan time} \\ &= 22.22\ \text{ms} + \text{scan time}\end{aligned}$$

2. I/O data refresh time of node 1 and subsequent nodes

$$\begin{aligned}\mathbf{I/O\ data\ refresh\ time} &= 22.22\ \text{ms} + \{ 7 \times 1.2\ \text{ms} + 32 \times 0.3\ \text{ms} + 11 \times 0.04\ \text{ms} + 9 \times 0.17\ \text{ms} + 4 \times 0.34\ \text{ms} \\ &\quad + 7 \times 0.08\ \text{ms} + 19 \times 0.29\ \text{ms} + 0 \times 0.58\ \text{ms} + 5\ \text{ms} \} \div 2 + \text{scan time} \\ &= 38.42\ \text{ms} + \text{scan time}\end{aligned}$$

Notes:

- The scan time is the time duration for executing one cycle of the user program that is cyclically executed.
- The scan time can be checked with special data register D8023 (Scan Time Current Value (ms)).

HMI Module

The HMI module is connected to the CPU module's communication connector.

You can run and stop the user program, monitor device values, and modify settings using the LCD and operation buttons on the HMI module. The HMI module also features the maintenance communication function, web server function, and send e-mail function using Ethernet communication.

For details on the HMI module functions, the menu screen, and the operation methods, see "HMI Function" on page 7-1.

Parts Description

FC6A-PH1

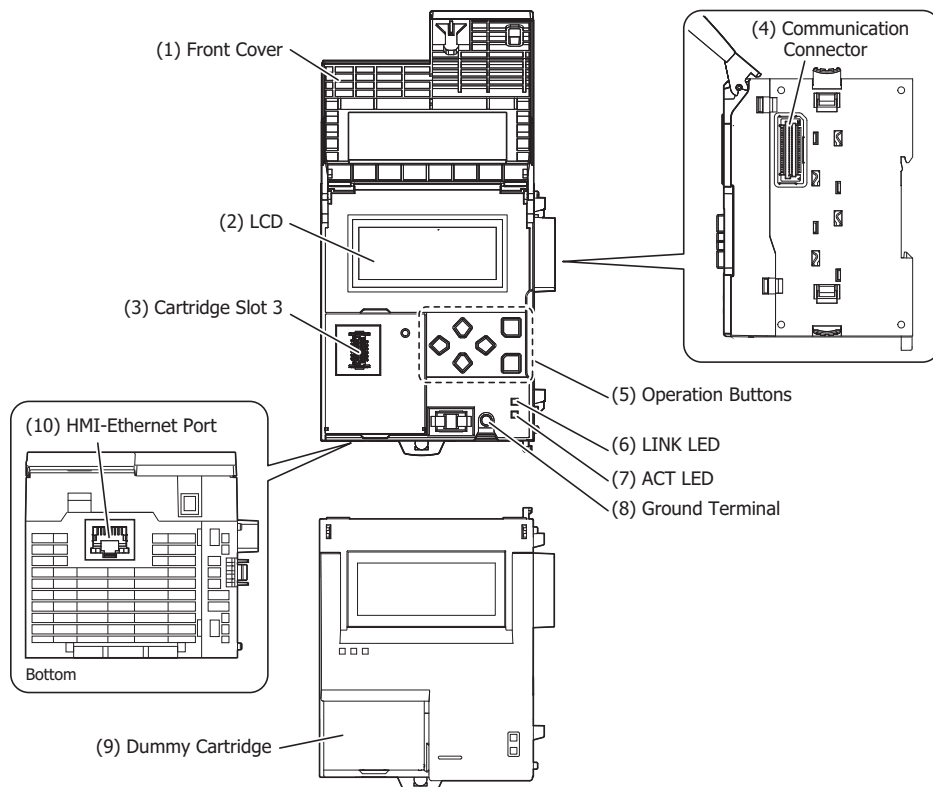

(1) Front Cover

This cover prevents the mistaken operation of the operation buttons. Open the front cover when using the operation buttons and when installing or ejecting the cartridge.

(2) LCD

Displays the menus to control the FC6A Series MICROSmart and display the status and settings for the FC6A Series MICROSmart.







(3) Cartridge Slot 3

This slot is used for installing a cartridge. However, a communication cartridge cannot be used in cartridge slot 3 of the All-in-One CPU module. A communication cartridge can be used in cartridge slot 3 of the Plus CPU module.

(4) Communication Connector

Connects the HMI module and the CPU module.

(5) Operation Buttons

Selects the display menu on the LCD and other functions. There are six buttons:  (Up),  (Down),  (Left),  (Right),  (ESC),  (OK).

(6) LINK LED

This LED is on when a network-compatible device is connected to the HMI-Ethernet port with an Ethernet cable.

(7) ACT LED

This LED flashes when sending or receiving data while the LINK LED is on.

(8) Ground Terminal

The functional ground terminal.

(9) Dummy Cartridge

A removable dummy cartridge that protects the cartridge slot. Remove the dummy cartridge when connecting a cartridge.

(10) HMI-Ethernet Port

This port allows Ethernet communication with connected devices that are equipped with an Ethernet interface.

Function Specifications

Type No.	FC6A-PH1	
Rated Power Voltage (Supplied from Module)		5V DC
		24V DC
Connector	HMI-Ethernet Port	RJ45
	Insertion/Removal Durability	100 times minimum
Module	5V DC	300 mA
Internal Current Draw		
	24V DC	15 mA
Ground	D-type ground (Type 3 ground)	
Ground Wire	UL1007 AWG18	
Weight	170 g	

■ HMI-Ethernet Port Specifications

Points	1
Communication Type	IEEE 802.3 compliant
Communication Speed	10BASE-T, 100BASE-TX
Communication Functions	Maintenance communication
Connector	RJ45 (Auto MDI/MDI-X compatible)
Cable	CAT 5 or higher, STP
Maximum Cable Length	100 m
Isolation between Internal Circuit	Pulse transformer isolated

■ Ethernet Communication Specifications

Number of Connections	8 maximum
Communication Mode	Maintenance Communication
Web Server Function	Yes
Web Data Storage	FROM
Web Data Capacity	5 Mbyte (Total size of the system web page and user web page)
Send E-mail Function	Yes

■ LCD Specifications

Type	STN monochrome LCD
Resolution	64 x 192 pixels
Number of Characters	24 digits x 8 lines (8 x 8 pixel font)
	12 digits x 8 lines (16 x 8 pixel font)
	12 digits x 4 lines (16 x 16 pixel font)
Display Content	System menus, messages, operation status monitor
Contrast Adjustment	Not possible
Backlight	Yes (can be turned on and off)

Cartridge Base Module

The cartridge base module can be connected to the communication connector on the Plus CPU module to allow the use of cartridges. The cartridge base module is equipped with cartridge slots 1 and 2. One cartridge base module can be connected to the Plus CPU module.

Part Names and Functions

FC6A-HPH1

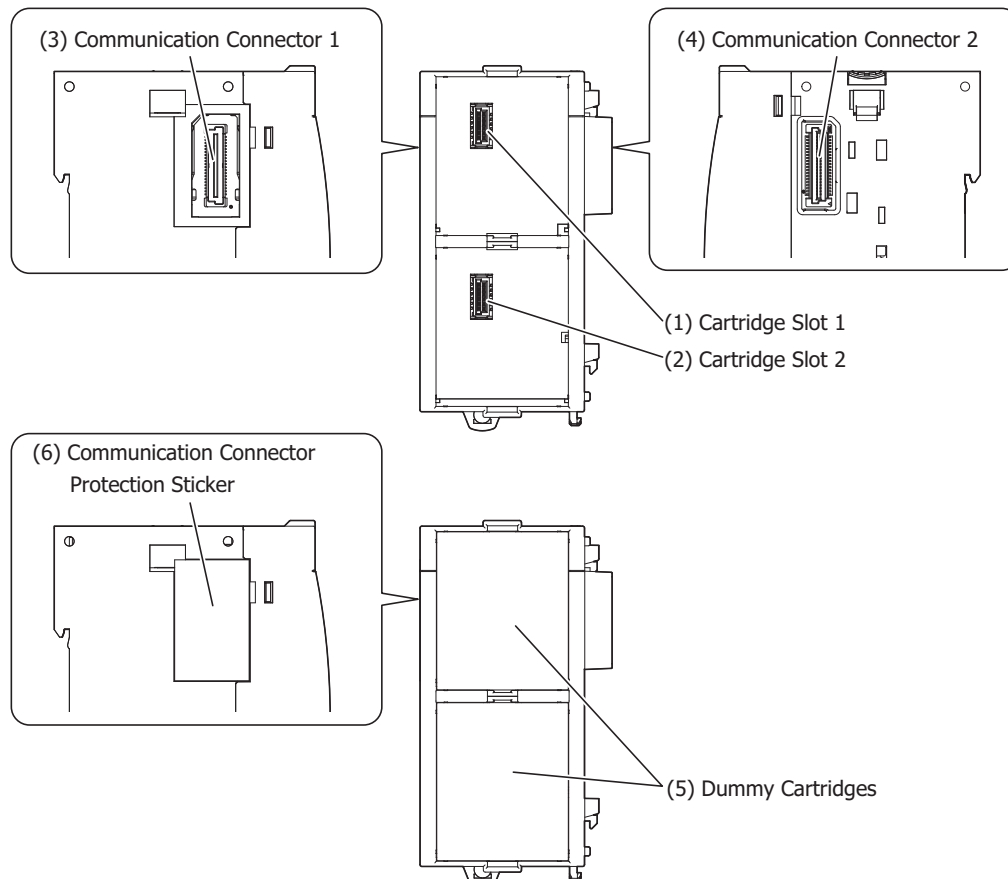

(1) Cartridge Slot 1

This slot is used to connect a digital I/O cartridge, analog I/O cartridge, or communication cartridge.

(2) Cartridge Slot 2

This slot is used to connect a digital I/O cartridge, analog I/O cartridge, or communication cartridge.

(3) Communication Connector 1

This connector is used to connect an HMI module.

(4) Communication Connector 2

This connector is used to connect the module to the Plus CPU module.

Note: The cartridge base module cannot be connected to the All-in-One CPU module or CAN J1939 All-in-One CPU module.

(5) Dummy Cartridges

Removable dummy cartridges that protect the cartridge slots. Remove the dummy cartridge when connecting a digital I/O cartridge, analog I/O cartridge, or communication cartridge.

(6) Communication Connector Protection Sticker

This sticker protects the communication connector. Remove the communication connector protection sticker when connecting the HMI module.

Function Specifications

Type No.	FC6A-HPH1
Number of connected cartridges	2 maximum
Weight	90 g

Notes:

- Do not install the cartridge base module in the Plus CPU module or remove it from the Plus CPU module when the Plus CPU module is powered. Otherwise there is a risk of damage.
- Do not touch the connectors on the back of the cartridge when installing or removing it. Otherwise there is a risk of damaging the connectors and making poor contact with module.

2: PRODUCT SPECIFICATIONS

Cartridges

Three types of cartridges are available for the FC6A Series MICROSmart: digital I/O cartridges that expand the number of digital inputs or outputs, analog I/O cartridges that expand the number of analog inputs or outputs, and communication cartridges that expand RS-232C communication ports, RS-485 communication ports, or Bluetooth communication ports.

Digital I/O Cartridges

Digital I/O cartridges expand the system with four digital inputs or outputs. Those cartridges can be connected to cartridge slots on the All-in-One CPU module, CAN J1939 All-in-One CPU module, the cartridge base module, or the HMI module. For details on digital cartridges, see "Digital I/O Cartridge" on page 10-1.

Digital I/O Cartridge Specifications

Part Names and Functions

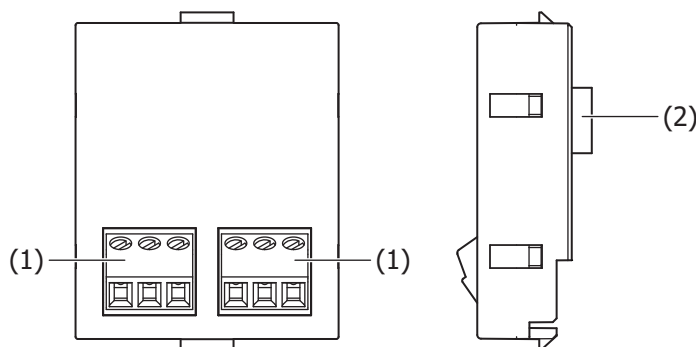

(1) Terminals

These terminals connect the cartridge to the power supply and to input or output devices. The devices that can be connected differ by the type of digital I/O cartridge.

(2) Connector

This connector connects the cartridge to Cartridge Slot 1 or 2 of the All-in-One CPU module or the cartridge base module.

Model List

Cartridge Type	I/O Points	I/O Signal	Type No.
Digital input cartridge	Input 4	DC input (shared sink/source): 12/24V DC	FC6A-PN4
Digital output cartridge	Output 4	Transistor sink output: 12/24V DC	FC6A-PTK4
		Transistor source output: 12/24V DC	FC6A-PTS4

Function Specifications

Type No.	FC6A-PN4	FC6A-PTK4	FC6A-PTS4
Rated Power Voltage	5.0 V, 3.3 V (supplied from CPU module)		
Current Draw	5.0 V: 0 mA 3.3 V: 35 mA		
Weight	15 g		

Digital Input Specifications

Type No.	FC6A-PN4	
Rated Input Voltage	12/24V DC (shared sink/source)	
Operating Load Voltage Range	0 to 28.8V DC	
Rated Input Current	5 mA/1 point (when 24V DC) 2.5 mA/1 point (when 12V DC)	
Terminal Arrangement	See "Wiring Arrangement and Wiring Examples" on page 2-167.	
Input Impedance	4.4 kΩ	
Input Delay Time (24V DC)	Turn ON Time	0.5 ms
	Turn OFF Time	0.5 ms
External Load for I/O Interconnection	Not needed	
Signal Determination Method	Static	
Effect of Improper Input Connection	Even if wiring for sink or source connection is incorrect, no damages are caused. If any input exceeding the rated value is applied, permanent damage may be caused.	
Cable Length	3 m	

Input Operating Range

The operating range of Type 1 (IEC 61131-2) DC input modules is as follows.

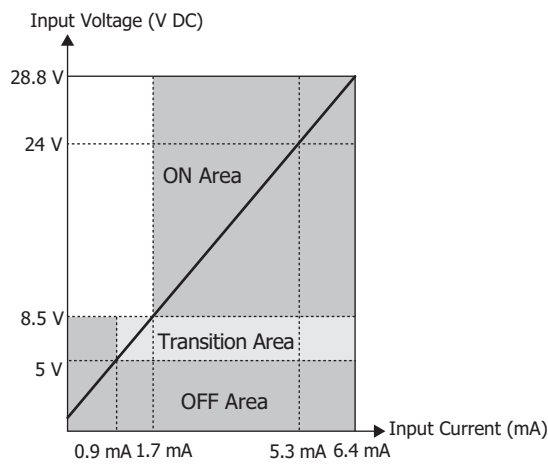

Input Internal Circuit

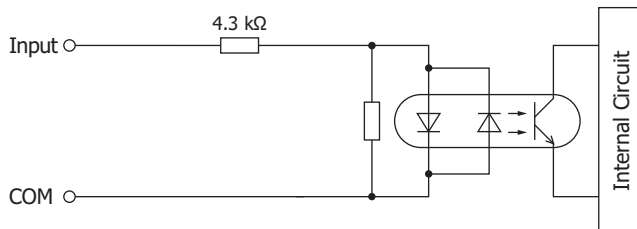

2: PRODUCT SPECIFICATIONS

Digital Output Specifications

Type No.	FC6A-PTK4	FC6A-PTS4
Output Signal	Transistor sink output	Transistor source output
Rated Load Voltage	12/24V DC	
Operating Load Voltage Range	10.2 to 28.8V DC	
Output Points	4 (4 points in 1 common line)	
Rated Load	0.1 A/1 point	
Terminal Arrangement	See "Wiring Arrangement and Wiring Examples" on page 2-167.	
Voltage Drop (ON Voltage)	0.4 V or less, voltage between COM and output terminal when ON	
Allowed Inrush Current	1 A maximum	
Leakage Current	0.1 mA maximum	
Clamping Voltage	50 V	
Lamp Load	2.4 W maximum	
Inductive Load	L/R = 10 ms (28.8V DC, 1 Hz)	
Protection Operation	None	
External Current Draw	100 mA maximum, 24V DC (+V terminal supply power)	
Output Delay Time (24V DC)	Turn ON Time	450 μ s maximum
	Turn OFF Time	450 μ s maximum

Output Internal Circuit

FC6A-PTK4

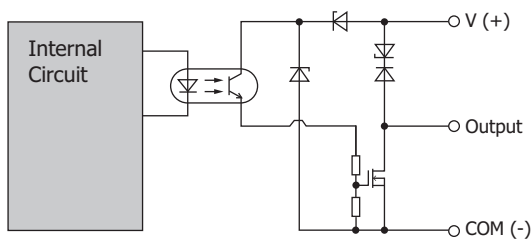

FC6A-PTS4

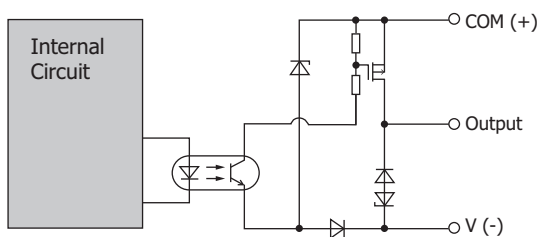

Wiring Arrangement and Wiring Examples

FC6A-PN4

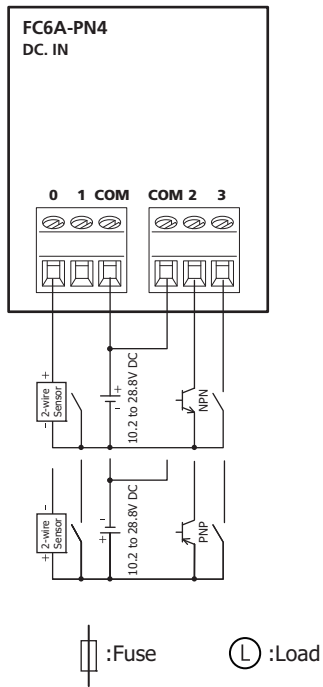

FC6A-PTK4

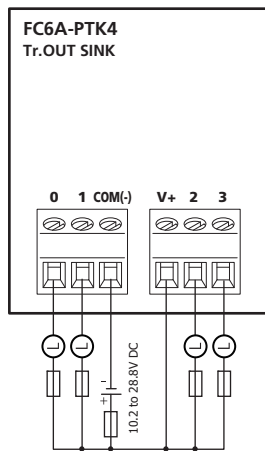

(L) Rated Load: 12 to 24V DC/0.1 A

FC6A-PTS4

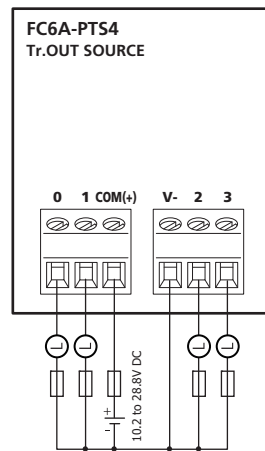

Insert a fuse that corresponds to the load.

2: PRODUCT SPECIFICATIONS

Analog I/O Cartridges

Analog I/O cartridges can be connected to cartridge slots on the All-in-One CPU module, CAN J1939 All-in-One CPU module, cartridge base module, or HMI module. These cartridges expand the system with a maximum of six analog inputs or outputs. For details on analog I/O cartridges, see "Analog I/O Cartridge" on page 10-7.

Parts Description

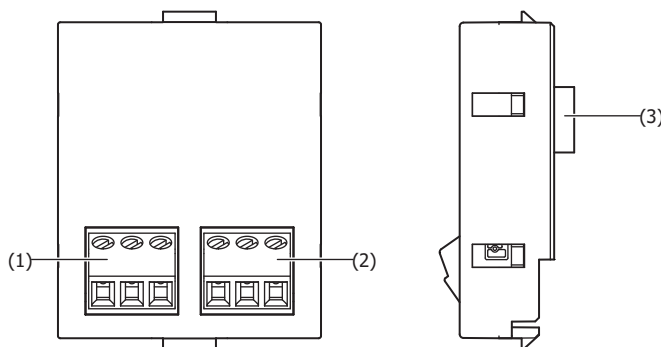

(1) Channel 0 terminals

The terminals connect an input device or an output device. The devices that can be connected differ by the type of analog I/O cartridge.

(2) Channel 1 terminals

The terminals connect an input device or an output device. The devices that can be connected differ by the type of analog I/O cartridge.

(3) Connector

Connects the cartridge to cartridge slot 1 or 2 on the All-in-One CPU module, CAN J1939 All-in-One CPU module, or cartridge base module or cartridge slot 3 on the HMI module.

Model List

Cartridge Type	I/O Points		I/O Signal	Type No.
Analog output cartridge	Output	2	Voltage output: 0 to 10V DC	FC6A-PK2AV
	Output	2	Current output: 4 to 20mA DC	FC6A-PK2AW
Analog input cartridge	Input	2	Voltage input: 0 to 10V DC Current input: 0 to 20mA DC, 4 to 20mA DC	FC6A-PJ2A
	Input	2	Thermocouple input: K, J, R, S, B, E, T, N, C Resistance thermometer input: Pt100, Pt1000, Ni100, Ni1000	FC6A-PJ2CP

Function Specifications

Type No.	FC6A-PK2AV	FC6A-PK2AW	FC6A-PJ2A	FC6A-PJ2CP
Rated Power Voltage	5.0 V, 3.3 V (supplied from module)			
Current Draw	5.0 V: 70 mA 3.3 V: 30 mA	5.0 V: 185 mA 3.3 V: 30 mA	5.0 V: — 3.3 V: 30 mA	5.0 V: — 3.3 V: 30 mA
Weight	15 g	15 g	15 g	15 g

■ Analog Output Specifications

Type No.		FC6A-PK2AV	FC6A-PK2AW
Output Type and Output Range	Voltage	0 to 10V DC	—
	Current	—	4 to 20mA DC
Load	Impedance	2 kΩ or higher	500 Ω or lower
	Load Type	Resistive load	
DA Conversion	DA Conversion Time	Max 40 ms	Max 20 ms
	Output Update Interval	20 ms	20 ms
	Total Output System Transfer Time	DA conversion time + Output Update Interval + 1 scan time	
Output Error	Maximum Error at 25°C	±0.3% of full scale	±0.3% of full scale
	Temperature Coefficient	±0.02% of full scale/°C	±0.02% of full scale/°C
	Output Ripple	Max 30 mV	Max 30 mV
	Overshoot	0%	0%
Data	Digital Resolution	4,096 steps (12 bits)	4,096 steps (12 bits)
	Input Value per Step	2.44 mV (0 to 10 V)	3.91 μA (4 to 20 mA)
	Data Type in Application Program	0 to 4,095 (0 to 10 V)	0 to 4,095 (4 to 20 mA)
	Monotonicity	Yes	Yes
	Current Loop Open	—	Not detectable
Noise Resistance	Maximum Temporary Deviation during Electrical Noise Tests	Max ±4.0% of full scale	Max ±4.0% of full scale
	Recommended Cable	Pair shielded cable	
	Crosstalk	MAX 1 LSB	MAX 1 LSB
Isolation		None	None
Effect of Improper Output Connection		No damage	No damage
Calibration or Verification to Maintain Rated Accuracy		Not possible	Not possible

■ Analog Input Specifications

Type No.	FC6A-PJ2A		FC6A-PJ2CP		
Input Type	Voltage	Current	Resistance Thermometer	Thermocouple	
Input Type and Input Range	0 to 10V DC	4 to 20mA DC 0 to 20mA DC	Pt100: -200 to 850°C (-328 to 1,562°F) Pt1000: -200 to +600°C (-328 to 1,112°F) Ni100: -60 to +180°C (-76 to 356°F) Ni1000: -60 to +180°C (-76 to 356°F)	(K) -200 to 1,300°C (-328 to 2,372°F) (J) -200 to 1,000°C (-328 to 1,832°F) (R) 0 to 1,760°C (32 to 3,200°F) (S) 0 to 1,760°C (32 to 3,200°F) (B) 0 to 1,820°C (32 to 3,308°F) (E) -200 to 800°C (-328 to 1,472°F) (T) -200 to 400°C (-328 to 752°F) (N) -200 to 1,300°C (-328 to 2,372°F) (C) 0 to 2,315°C (32 to 4,199°F)	
Input Impedance	Min 1 MΩ	Max 250 Ω	Min 1 MΩ		
Allowed Conductor Resistance	—	—	Max 10 Ω	—	
Detected Input Current	—	—	TYP: 0.2 mA Max 1.0 mA		
AD Conversion	Sampling Time	10 ms	10 ms	250 ms	
	Sampling Repetition Time	20 ms		500 ms	
	Total Input Delay Time*1	Sampling time + Sampling repetition time + 1 scan time			
	Type of Input	Single-ended			
	Operation Mode	Self-scan			
	Conversion Method	SAR			

2: PRODUCT SPECIFICATIONS

Type No.	FC6A-PJ2A		FC6A-PJ2CP		
Input Type	Voltage	Current	Resistance Thermometer	Thermocouple	
Input Error	Maximum Error at 25°C	±0.1% of full scale		±0.1% of full scale Cold junction compensation accuracy ±4.0°C or lower Exceptions R, S thermocouple error: ±6.0°C (0 to 200°C range only) B thermocouple error: Not guaranteed (0 to 300°C range only) K, J, E, T, N thermocouple error: ±0.4% of full scale (0°C or lower range only)	
	Temperature Coefficient	±0.02% of full scale/°C		±0.02% of full scale/°C	
Data	Digital Resolution	4,096 steps (12 bits)		Pt100: Approx. 10,500 (equivalent to 14 bits) Pt1000: Approx. 8,000 (equivalent to 13 bits) Ni100: Approx. 2,400 (equivalent to 12 bits) Ni1000: Approx. 2,400 (equivalent to 12 bits) K: 15,000 (14 bits) J: 12,000 (14 bits) R: 17,600 (15 bits) S: 17,600 (15 bits) B: 18,200 (15 bits) E: 10,000 (14 bits) T: 6,000 (13 bits) N: 15,000 (14 bits) C: 23,150 (15 bits)	
	Input Value per Step	2.44 mV (0 to 10V DC)	4.88 µA (0 to 20mA DC) 3.91 µA (4 to 20mA DC)	0.1°C 0.18°F	
	Application Data Type	Can be arbitrarily set for each channel in a range between -32,768 to 32,767*2			
	Monotonicity	Yes			
	Input Data Out of Range	Detectable*3			
Noise Resistance	Maximum Temporary Deviation during Electrical Noise Tests	Max ±4.0% of full scale			
	Recommended Cable	Pair shielded cable	Pair cable		
	Crosstalk	Max 1 LSB			
Isolation	None				
Effect of Improper Input Connection	No damage				
Maximum Permanent Allowed Overload*4 (No Damage)	13 V	40 mA	13 V		
Selection of Input Type and Input Range	Using programming software				
Calibration or Verification to Maintain Rated Accuracy	Not possible				

*1 Total input delay time indicates the total value of the sampling repetition time plus the internal processing time. The total input delay time increases in proportion to the number of channels used.

*2 The arbitrary setting is a function that uses the digital resolution data by scaling it to arbitrary data (that arbitrarily sets the lower limit value and the upper limit value). The range setting (-32,768 to 32,767) is specified with data registers.

Example: When -5 V is input, 1,024 is displayed as long as the arbitrary setting is not configured, but -500 is displayed when the arbitrary setting is configured as upper limit value = 1,000 and lower limit value = -1,000, and this makes it easier to intuitively read the input voltage value.

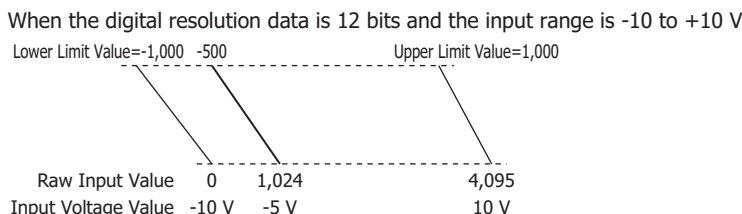

*3 Input data out of range is reflected in the status of the analog I/O module.

*4 The maximum voltage/current value that can be input without damage.

Output Internal Circuit

FC6A-PK2AV, FC6A-PK2AW

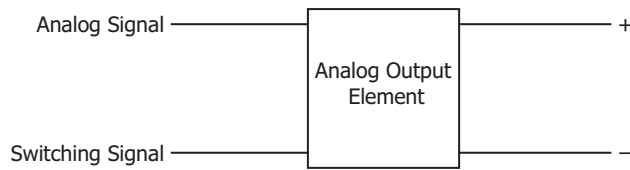

Input Internal Circuit

FC6A-PJ2A

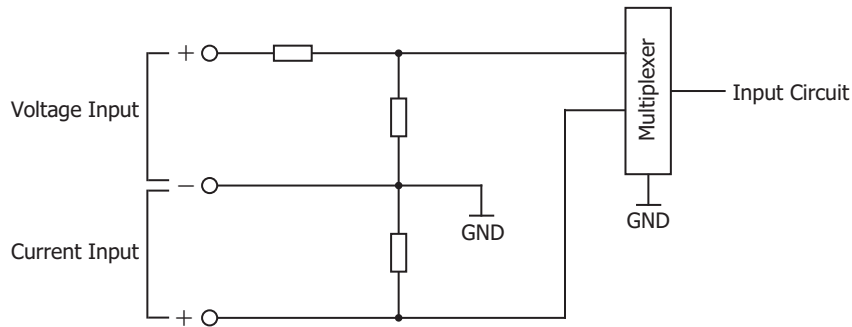

FC6A-PJ2CP

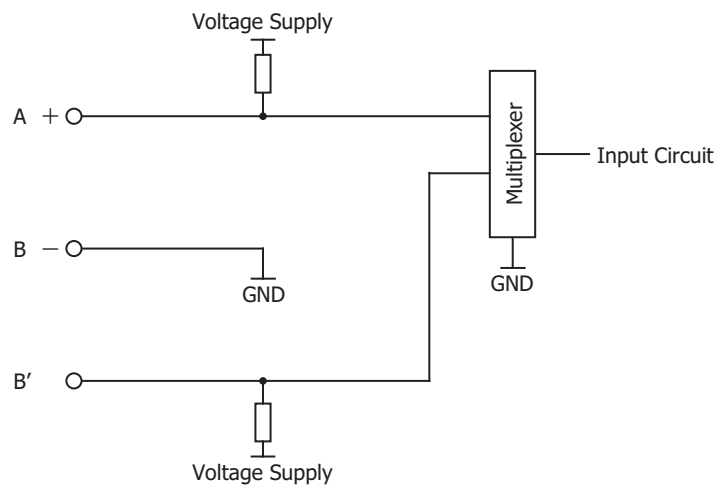

2: PRODUCT SPECIFICATIONS

Wiring Arrangement and Wiring Examples



Caution

- Do not connect a thermocouple to a part with hazardous voltage (60V DC or peak 42.4V DC or higher part).
- Before turning on the power, please check that the wiring is correct. If the wiring is incorrect, the analog I/O cartridge may be damaged. When the analog I/O cartridge may malfunction due to noise, wire it with a shielded cable and connect both ends to the FE.
- When connecting cables to the analog I/O cartridges, the tightening torque is 0.22 to 0.25 Nm.

FC6A-PK2AV

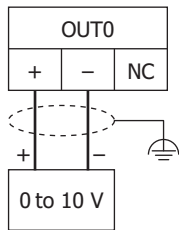

Analog Voltage Input Device

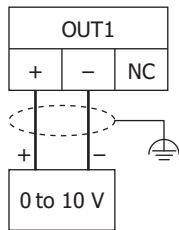

Analog Voltage Input Device

FC6A-PK2AW

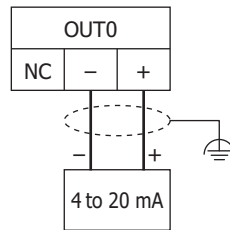

Analog Current Input Device

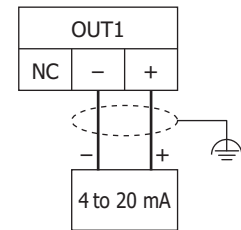

Analog Current Input Device

FC6A-PJ2A

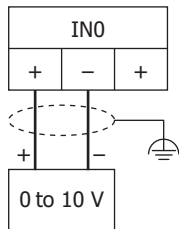

Analog Voltage Output Device

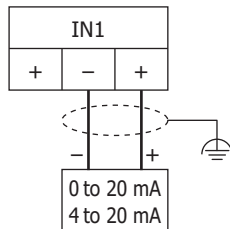

Analog Current Output Device

FC6A-PJ2CP

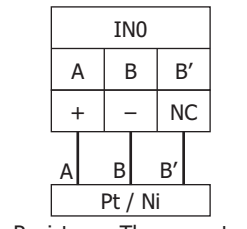

Resistance Thermometer

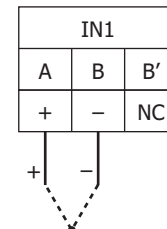

Thermocouple

Communication Cartridges

Communication cartridges can be connected to cartridge slots on the All-in-One CPU module, CAN J1939 All-in-One CPU module, the cartridge base module, or HMI module connected to the Plus CPU module. These cartridges expand the system with RS-232C, RS-485, or Bluetooth communication ports.

Note: The cartridge slot on the HMI module connected to the All-in-One CPU module or CAN J1939 All-in-One CPU module cannot be used.

RS-232C and RS-485 Communication Cartridges

The RS-232C and RS-485 communication cartridges support the maintenance communication, user communication, and Modbus communication. The RS-485 communication cartridge also supports the data link communication.

Parts Description

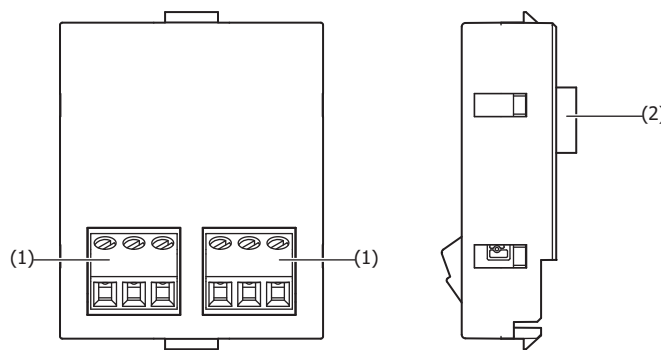

(1) Terminals

These terminals connect a device equipped with a serial interface (RS-232C or RS-485). The devices that can be connected differ by the type of communication cartridge.

(2) Connector

The connector used to connect the cartridge to cartridge slot 1 or 2 on the All-in-One CPU module, CAN J1939 All-in-One CPU module, or cartridge base module or cartridge slot 3 on the HMI module connected to the Plus CPU module.

Model List

Cartridge Type	Points	Type	Type No.
RS-232C communication cartridge	1	Serial interface (RS-232C)	FC6A-PC1
RS-485 communication cartridge	1	Serial interface (RS-485)	FC6A-PC3

2: PRODUCT SPECIFICATIONS

Function Specifications

Type No.	FC6A-PC1	FC6A-PC3
Rated Power Voltage	5.0 V, 3.3 V (supplied from module)	5.0 V, 3.3 V (supplied from module)
Current Draw	5.0 V: Max 23 mA 3.3 V: Max 6 mA	5.0 V: Max 23 mA 3.3 V: Max 6 mA
Weight	15 g	15 g

■ Communication Specifications

Type No.	FC6A-PC1	FC6A-PC3
Electrical Characteristics	EIA RS232C	EIA RS485
Maximum Communication Speed	115,200 bps	115,200 bps
Maintenance Communication	Yes	Yes
User Communication	Yes	Yes
Data Link Communication	Yes	Yes
Modbus Master	Yes	Yes
Modbus Slave	Yes	Yes
Maximum Cable Length	5 m	200 m
Isolation between Internal Circuit	Not isolated	Not isolated
Cable	Recommended Cable	
	Shielded multicore cable: 24 AWG	Shielded twisted-pair cable: 24 AWG



Caution

When connecting cables to the communication cartridges, the tightening torque is 0.22 to 0.25 Nm.
Recommended screwdriver: SZS 0.4×2.5 (Phoenix Contact) and SDS 0.4×2.5×75 (Weidmüller)

Terminal Arrangement and Wiring Examples

Notes:

- For the cables to use for wiring, fabricate and use the recommended cable or an equivalent type of shielded cable.
- When there is a risk of malfunction due to noise, ground the shielded cables.
- Fully read and understand the manual for the device that will be connected to and communicate with the communication cartridge before wiring it.

FC6A-PC1

Terminal Name	I/O Direction	Signal Name, etc.
RS (RTS)^{*1}	Output	Request to send
ER (DTR)	Output	Data terminal ready
SD (TxD)	Output	Transmitted data
RD (RxD)	Input	Received data
DR (DSR)	Input	Data set ready
SG (SG)	—	Signal ground

*1 The RS terminal is a constant output terminal.

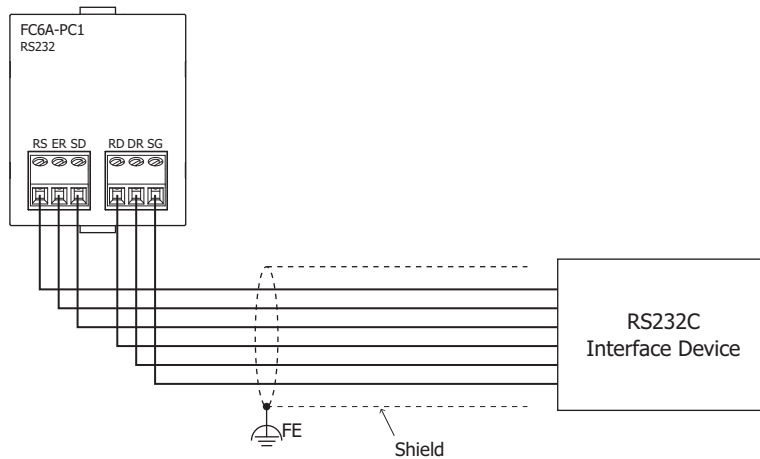

FC6A-PC3

Terminal Name	I/O Direction	Signal Name, etc.
A	I/O	Data A ^{*1}
B	I/O	Data B ^{*1}
SG	—	Signal ground ^{*1}

*1 The terminals are shorted inside the cartridge.

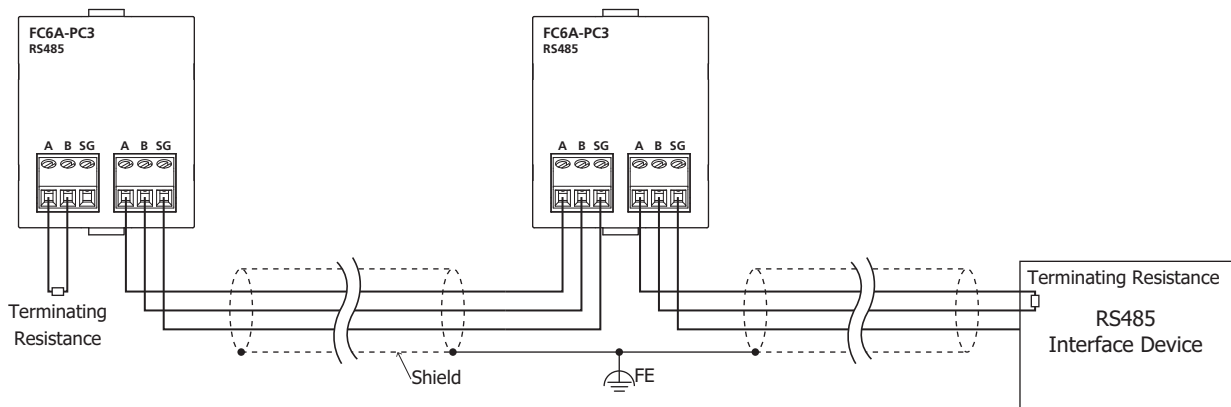

Note: When communication quality is unstable, add terminating resistance matched to the characteristic impedance to both ends of the cable. Use resistance with a rating of 1/2 W or higher.

2: PRODUCT SPECIFICATIONS

Bluetooth Communication Cartridge

The Bluetooth communication cartridge supports the maintenance communication and user communication.

■ Part Names and Functions

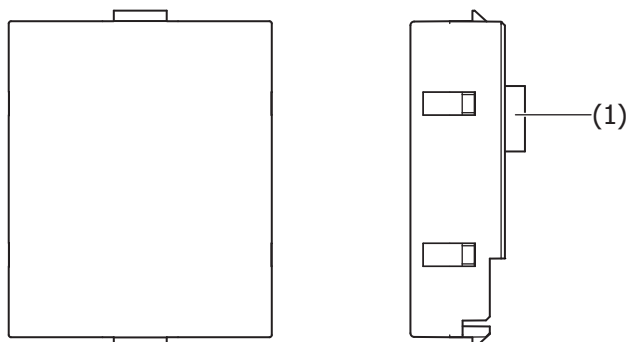

(1) Connector

The connector used to connect the cartridge to cartridge slot 1 or 2 or cartridge slot 3 on the HMI module connected to the Plus CPU module.

■ Function Specifications

Type No.	FC6A-PC4
Rated Power Voltage	5.0 V, 3.3 V (supplied from module)
Current Draw	5.0 V: 120 mA maximum 3.3 V: 30 mA maximum
Weight	15 g

Wireless Communication Specifications

Type No.	FC6A-PC4
Bluetooth Standard	Bluetooth ver.2.1 + EDR
Profile	SPP (Serial Port Profile) iAP (iPod Accessory Protocol)
Frequency Range	2,402 MHz to 2,480 MHz
Wireless Transmission Distance*1	10 m (Class 2)
Multi-point Function	8 units
Communication Protocol	Maintenance communication protocol, user communication protocol
Bluetooth Wireless Approved Regions*2	Japan, China, USA, Canada, Australia, New Zealand, Europe

*1 Connection effective range is affected by obstacles (human, metal, wall) and wave signal condition. Make sure to confirm the connection status before actual operation.

*2 Depending on countries or regions, evaluations on the device equipped with FC6A may be necessary.

Note: Communication performance (required time) in maintenance communication is as follows.

- User program upload equivalent to 10,000 steps: 40 seconds approx.
- User program download equivalent to 10,000 steps: 50 seconds approx.
- User program upload equivalent to 20,000 steps: 1 minute 20 seconds approx.
- User program download equivalent to 20,000 steps: 1 minute 40 seconds approx.
- 100 KB CSV file retrieval: 30 seconds approx.
- 200 KB CSV file retrieval: 1 minute approx.

Dimensions

CPU Modules

All-in-One CPU module

16-I/O Type: Screw fastened type: FC6A-C16R1AE, FC6A-C16R1CE, FC6A-C16K1CE, FC6A-C16P1CE, FC6A-C16R1DE, FC6A-C16K1DE, FC6A-C16P1DE

Push-in type: FC6A-C16R4AE, FC6A-C16R4CE, FC6A-C16K4CE, FC6A-C16P4CE, FC6A-C16R4DE, FC6A-C16K4DE, FC6A-C16P4DE

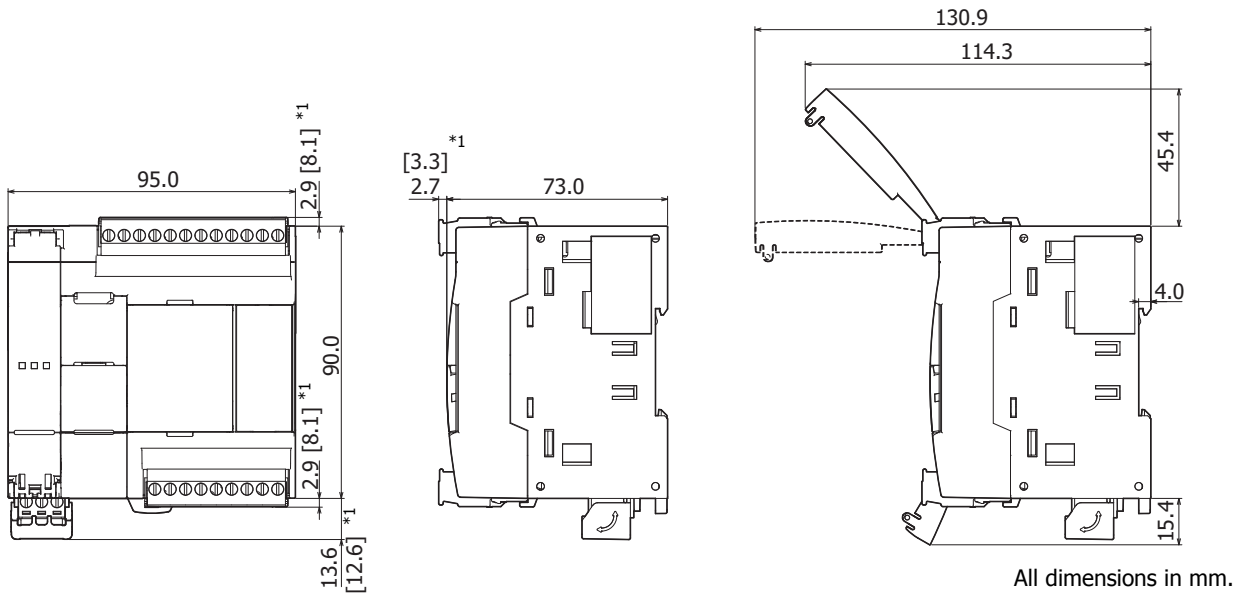

*1 The above drawing is for the screw fastened type. Dimensions for the push-in type are given in [].

24-I/O Type: Screw fastened type: FC6A-C24R1AE, FC6A-C24R1CE, FC6A-C24K1CE, FC6A-C24P1CE

Push-in type: FC6A-C24R4AE, FC6A-C24R4CE, FC6A-C24K4CE, FC6A-C24P4CE

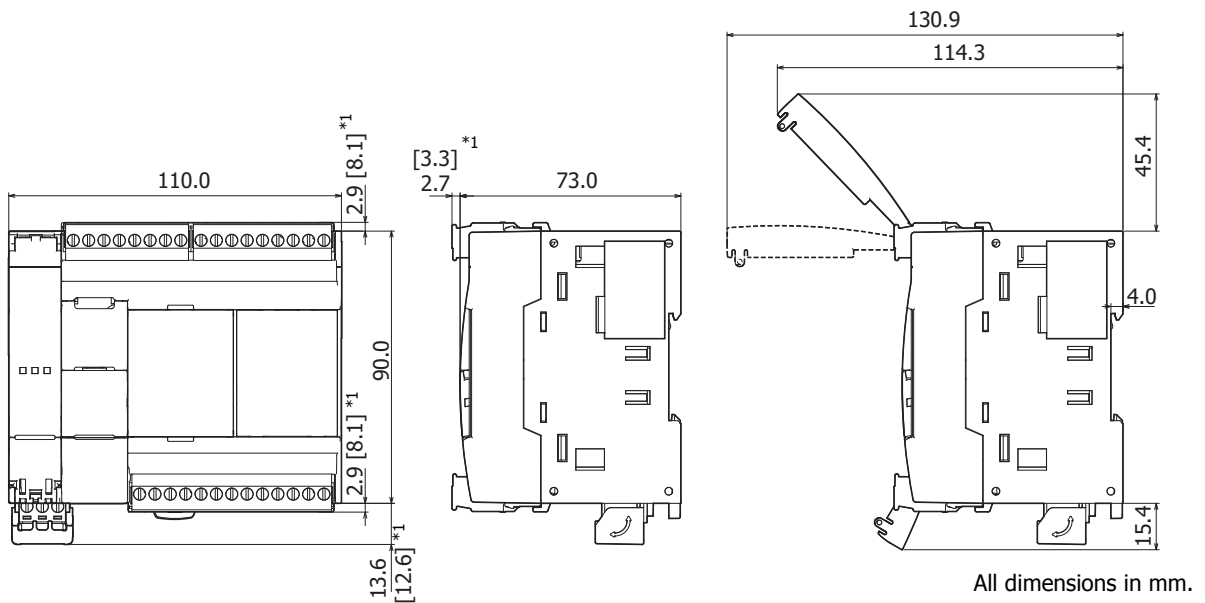

*1 The above drawing is for the screw fastened type. Dimensions for the push-in type are given in [].

2: PRODUCT SPECIFICATIONS

40-I/O Type: Screw fastened type: FC6A-C40R1AE, FC6A-C40R1CE, FC6A-C40K1CE, FC6A-C40P1CE, FC6A-C40R1DE, FC6A-C40K1DE, FC6A-C40P1DE

Push-in type: FC6A-C40R4AE, FC6A-C40R4CE, FC6A-C40K4CE, FC6A-C40P4CE, FC6A-C40R4DE, FC6A-C40K4DE, FC6A-C40P4DE

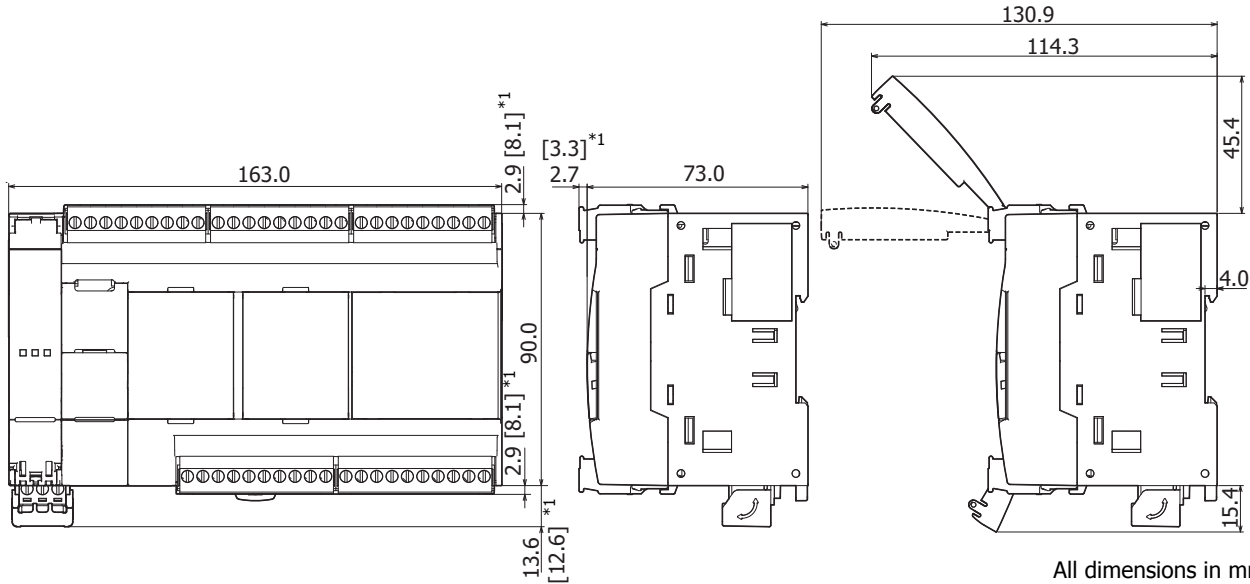

All dimensions in mm.

*1 The above drawing is for the screw fastened type. Dimensions for the push-in type are given in [].

CAN J1939 All-in-One CPU module

40-I/O Type: Screw fastened type: FC6A-C40R1AEJ, FC6A-C40R1CEJ, FC6A-C40K1CEJ, FC6A-C40P1CEJ, FC6A-C40R1DEJ, FC6A-C40K1DEJ, FC6A-C40P1DEJ

Push-in type: FC6A-C40R4AEJ, FC6A-C40R4CEJ, FC6A-C40K4CEJ, FC6A-C40P4CEJ, FC6A-C40R4DEJ, FC6A-C40K4DEJ, FC6A-C40P4DEJ

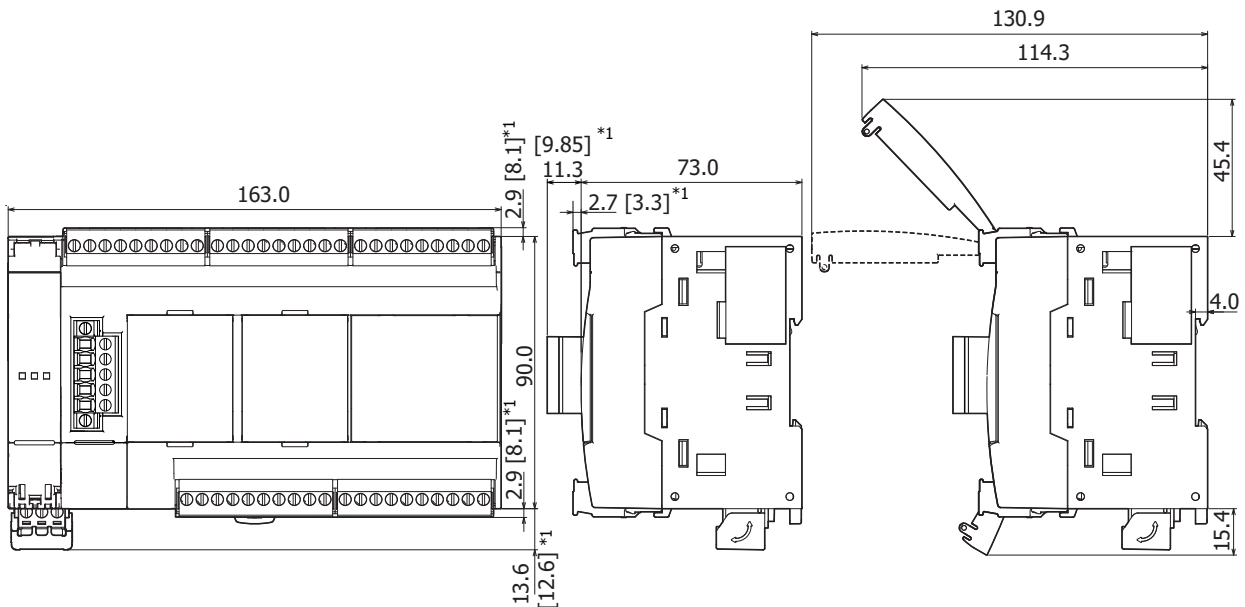

All dimensions in mm.

*1 The above drawing is for the screw fastened type. Dimensions for the push-in type are given in [].

Plus CPU module

Plus 16-I/O type: Screw fastened type: FC6A-D16R1CEE, FC6A-D16K1CEE, FC6A-D16P1CEE
 Push-in type: FC6A-D16R4CEE, FC6A-D16K4CEE, FC6A-D16P4CEE

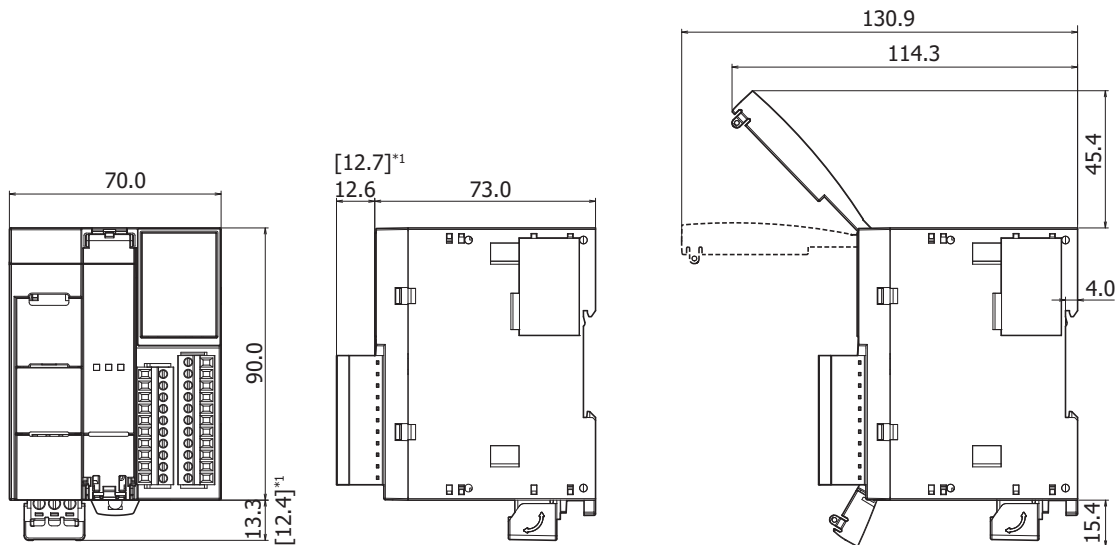

All dimensions in mm.

*1 The above drawing is for the screw fastened type. Dimensions for the push-in type are given in [].

Plus 32-I/O type: Screw fastened type: FC6A-D32K3CEE, FC6A-D32P3CEE
 Push-in type: FC6A-D32K4CEE, FC6A-D32P4CEE

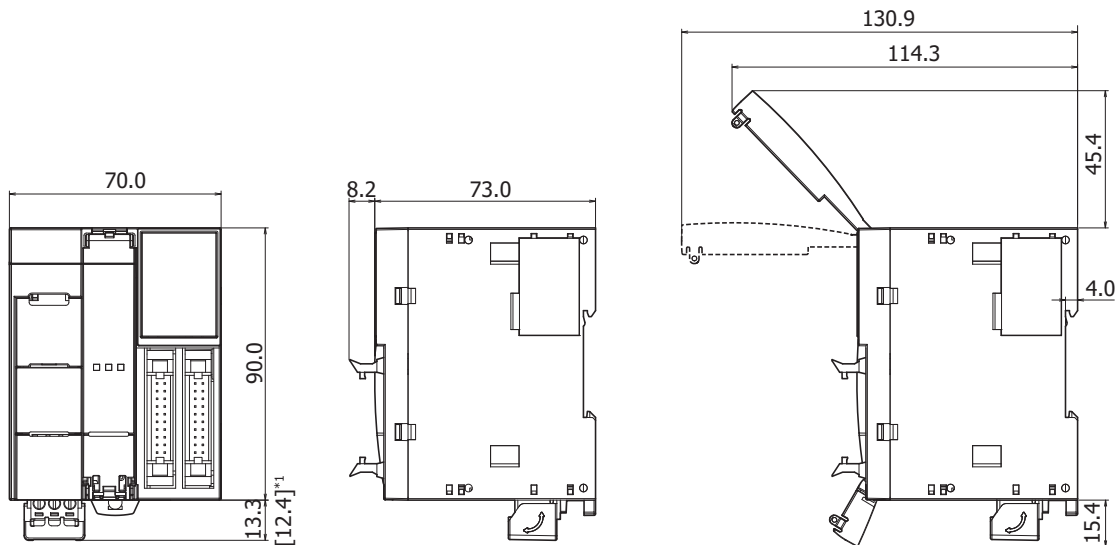

All dimensions in mm.

*1 The above drawing is for the screw fastened type. Dimensions for the push-in type are given in [].

2: PRODUCT SPECIFICATIONS

Expansion Modules

- Digital input modules:** Screw fastened type: FC6A-N08B1, FC6A-N08A11
Push-in type: FC6A-N08B4, FC6A-N08A14
- Digital output modules:** Screw fastened type: FC6A-R081, FC6A-T08K1, FC6A-T08P1
Push-in type: FC6A-R084, FC6A-T08K4, FC6A-T08P4
- Digital mixed I/O modules:** Screw fastened type: FC6A-M08BR1
Push-in type: FC6A-M08BR4
- Analog I/O modules:** Screw fastened type: FC6A-J2C1, FC6A-K2A1, FC6A-K4A1, FC6A-J4CN1
Push-in type: FC6A-J2C4, FC6A-K2A4, FC6A-K4A4, FC6A-J4CN4

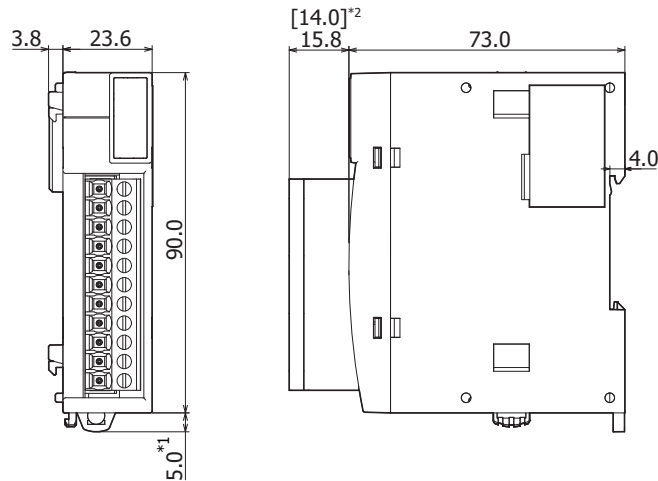

All dimensions in mm.

*1 9.3 mm when the hook is pulled out.

*2 The above drawing is for the screw fastened type. Dimensions for the push-in type are given in [].

- Digital input modules:** Screw fastened type: FC6A-N16B1
Push-in type: FC6A-N16B4
- Digital output modules:** Screw fastened type: FC6A-R161, FC6A-T16K1, FC6A-T16P1
Push-in type: FC6A-R164, FC6A-T16K4, FC6A-T16P4
- Analog I/O modules:** Screw fastened type: FC6A-J4A1, FC6A-J8A1, FC6A-J4CN1, FC6A-J4CH1Y,
FC6A-J8CU1, FC6A-L06A1
Push-in type: FC6A-J4A4, FC6A-J8A4, FC6A-J4CN4, FC6A-J4CH4Y, FC6A-J8CU4,
FC6A-L06A4
- Communication modules:** Screw fastened type: FC6A-SIF52
Push-in type: FC6A-SIF524

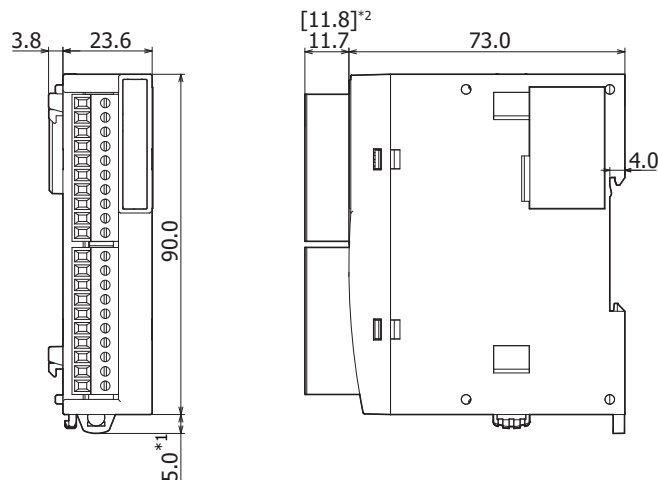

All dimensions in mm.

*1 9.3 mm when the hook is pulled out.

*2 The above drawing is for the screw fastened type. Dimensions for the push-in type are given in [].

Digital input modules: FC6A-N16B3
Digital output modules: FC6A-T16K3, FC6A-T16P3

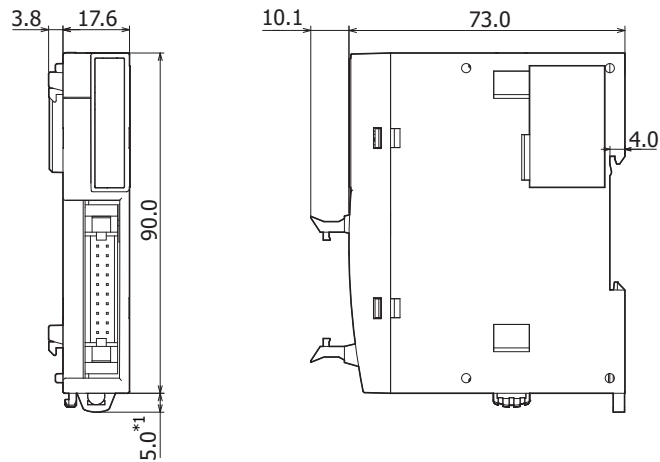

*1 9.3 mm when the hook is pulled out.

All dimensions in mm.

Digital input modules: FC6A-N32B3
Digital output modules: FC6A-T32K3, FC6A-T32P3

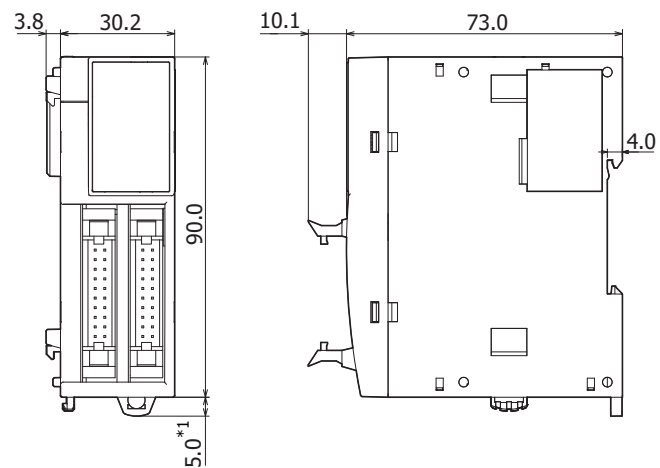

*1 9.3 mm when the hook is pulled out.

All dimensions in mm.

2: PRODUCT SPECIFICATIONS

Digital mixed I/O modules: Screw fastened type: FC6A-M24BR1

Push-in type: FC6A-M24BR4

PID modules:

Screw fastened type: FC6A-F2M1, FC6A-F2MR1

Push-in type: FC6A-F2M4, FC6A-F2MR4

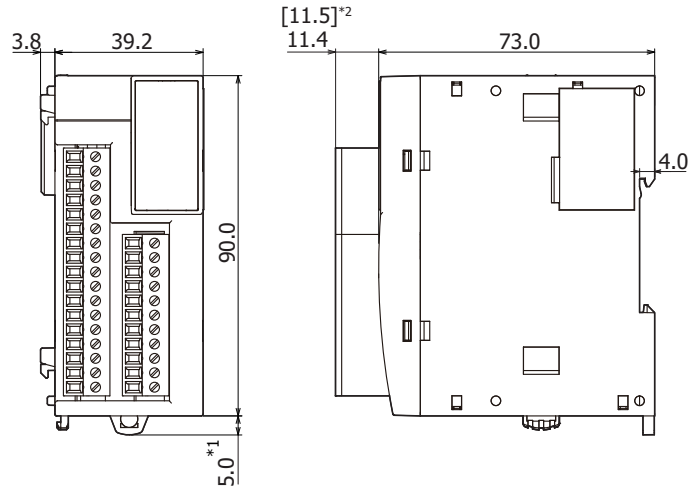

All dimensions in mm.

*1 9.3 mm when the hook is pulled out.

*2 The above drawing is for the screw fastened type. Dimensions for the push-in type are given in [].

Expansion Interface Module

Expander:

Screw fastened type: FC6A-EXM2

Push-in type: FC6A-EXM24

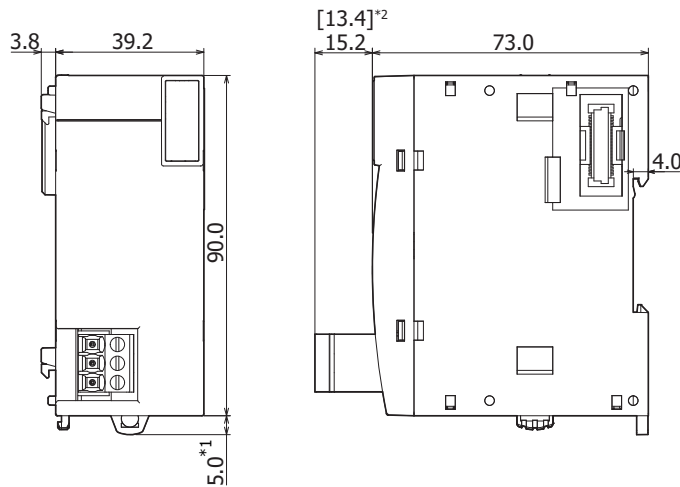

All dimensions in mm.

*1 9.3 mm when the hook is pulled out.

*2 The above drawing is for the screw fastened type. Dimensions for the push-in type are given in [].

Remote Master:

FC6A-EXM1M

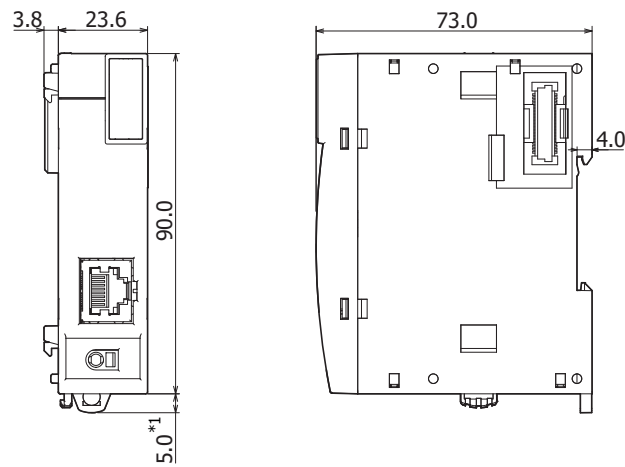

*1 9.3 mm when the hook is pulled out.

All dimensions in mm.

Remote Slave:

**Screw fastened type: FC6A-EXM1S
Push-in type: FC6A-EXM1S4**

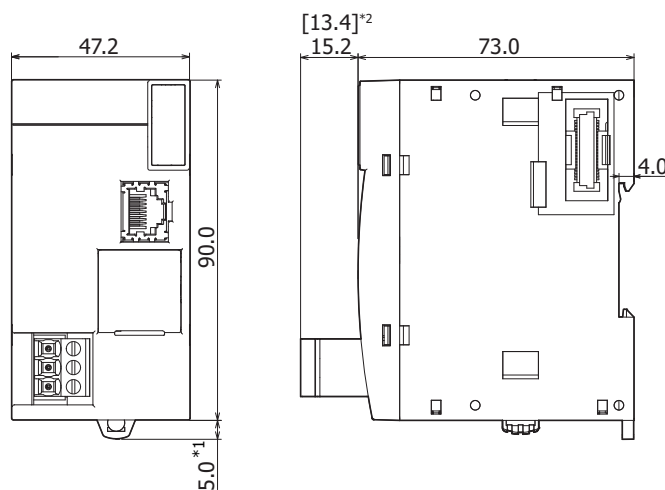

*1 9.3 mm when the hook is pulled out.

*2 The above drawing is for the screw fastened type. Dimensions for the push-in type are given in [].

All dimensions in mm.

2: PRODUCT SPECIFICATIONS

HMI Module

FC6A-PH1

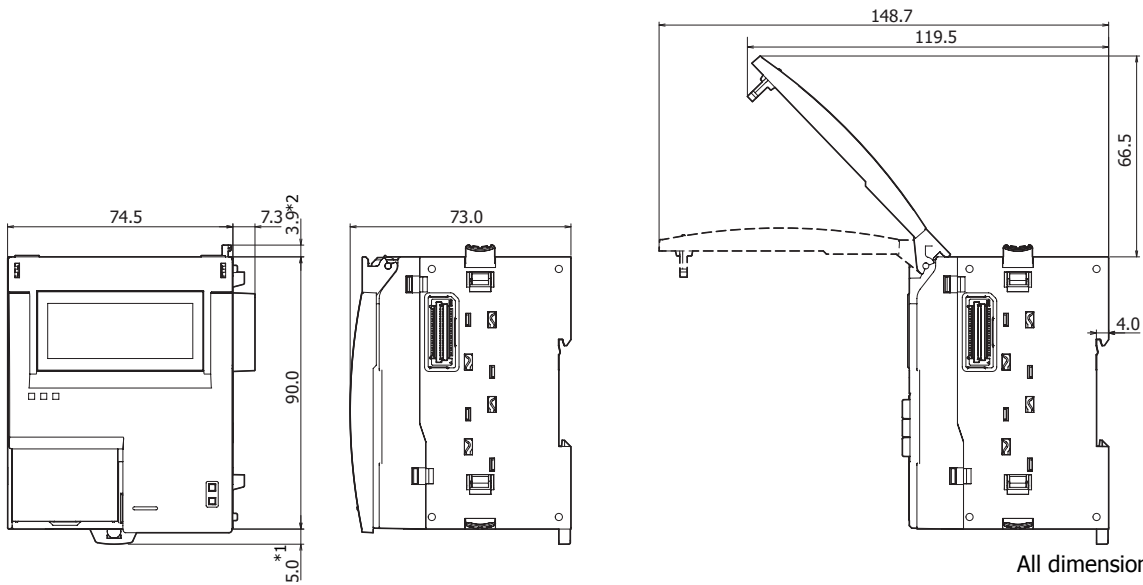

All dimensions in mm.

*1 9.3 mm when the hook is pulled out.

*2 This dimension is 0 mm when the eject button is locked.

Cartridge Base Module

FC6A-HPH1

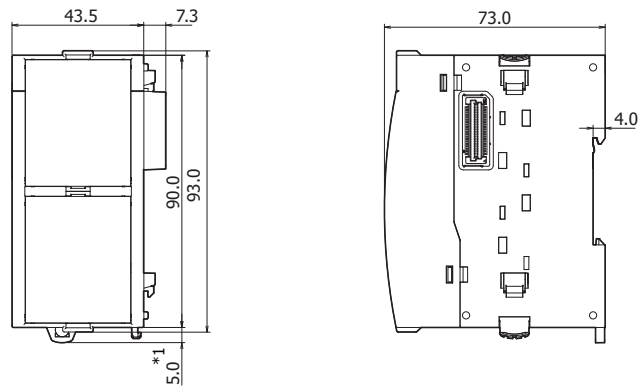

All dimensions in mm.

*1 9.3 mm when the hook is pulled out.

Cartridges

Digital I/O cartridges: FC6A-PN4, FC6A-PTK4, FC6A-PTS4

Analog I/O cartridges: FC6A-PK2AV, FC6A-PK2AW, FC6A-PJ2A, FC6A-PJ2CP

Communication cartridges: FC6A-PC1, FC6A-PC3

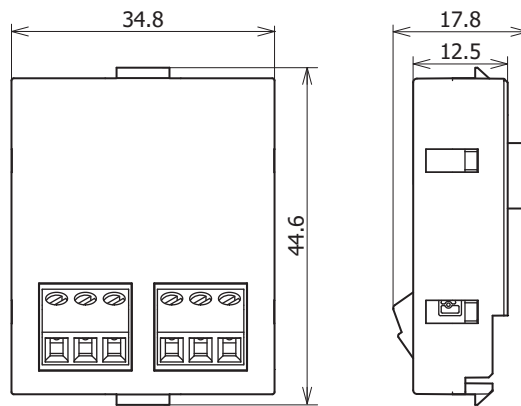

All dimensions in mm.

Communication cartridges: FC6A-PC4

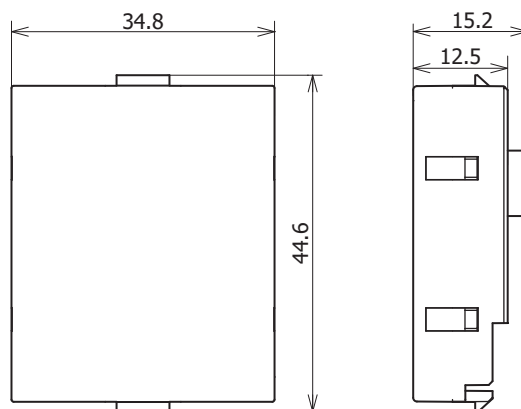

All dimensions in mm.

2: PRODUCT SPECIFICATIONS

Rating at Max Surrounding Air Temperature of 55°C/65°C

The input/output ratings at Max Surrounding Air Temperature of 55°C/65°C are as follows.

Model Names	Type	Air Temp	Inputs	Outputs
All-in-One CPU module	FC6A-C16R1AE	55°C	9 inputs: 24V DC, Input 0, 1, 6, 7: 5 mA/PT Others: 7 mA/PT	7 relay outputs: 240V AC / 30V DC, 2 A (GEN/RES) 7 A (Common)
		65°C	9 inputs: 24V DC, Input 0, 1, 6, 7: 5 mA/PT Others: 7 mA/PT Total Max. 28 mA, 4 PTs	7 relay outputs: 240V AC / 30V DC, 2 A (GEN/RES) 7 A (Common) Total Max. 6 A, 3 PTs
	FC6A-C16R1CE	55°C	9 inputs: 24V DC, Input 0, 1, 6, 7: 5 mA/PT Others: 7 mA/PT	7 relay outputs: 240V AC / 30V DC, 2 A (GEN/RES) 7 A (Common)
		65°C	9 inputs: 24V DC, Input 0, 1, 6, 7: 5 mA/PT Others: 7 mA/PT Total Max. 28 mA, 4 PTs	7 relay outputs: 240V AC / 30V DC, 2 A (GEN/RES) 7 A (Common) Total Max. 6 A, 3 PTs
	FC6A-C16P1CE	55°C	9 inputs: 24V DC, Input 0, 1, 6, 7: 5 mA/PT Others: 7 mA/PT	7 transistor source outputs: 24V DC, 0.5 A/PT Class 2
		65°C	9 inputs: 24V DC, Input 0, 1, 6, 7: 5 mA/PT Others: 7 mA/PT Total Max. 17 mA, 3 PTs	7 transistor source outputs: 24V DC, 0.5 A/PT Class 2 Total Max. 1 A, 2 PTs
	FC6A-C16K1CE	55°C	9 inputs: 24V DC, Input 0, 1, 6, 7: 5 mA/PT Others: 7 mA/PT	7 transistor sink outputs: 24V DC, 0.5 A/PT
		65°C	9 inputs: 24V DC, Input 0, 1, 6, 7: 5 mA/PT Others: 7 mA/PT Total Max. 17 mA, 3 PTs	7 transistor sink outputs: 24V DC, 0.5 A/PT Total Max. 1 A, 2 PTs
	FC6A-C16R1DE	55°C	9 inputs: 12V DC, Input 0, 1, 6, 7: 5 mA/PT Others: 6 mA/PT	7 relay outputs: 240V AC / 30V DC, 2 A (GEN/RES) 7 A (Common)
		65°C	9 inputs: 12V DC, Input 0, 1, 6, 7: 5 mA/PT Others: 6 mA/PT Total Max. 24 mA, 4 PTs	7 relay outputs: 240V AC / 30V DC, 2 A (GEN/RES) 7 A (Common) Total Max. 6 A, 3 PTs
	FC6A-C16P1DE	55°C	9 inputs: 12V DC, Input 0, 1, 6, 7: 5 mA/PT Others: 6 mA/PT	7 transistor source outputs: 12 V DC, 0.5 A/PT resistive Limited energy
		65°C	9 inputs: 12V DC, Input 0, 1, 6, 7: 5 mA/PT Others: 6 mA/PT Total Max. 18 mA, 3 PTs	7 transistor source outputs: 12 V DC, 0.5 A/PT resistive Total Max. 1A, 2 PTs Limited energy
	FC6A-C16K1DE	55°C	9 inputs: 12V DC, Input 0, 1, 6, 7: 5 mA/PT Others: 6 mA/PT	7 transistor sink outputs: 12 V DC, 0.5 A/PT resistive Limited energy
		65°C	9 inputs: 12V DC, Input 0, 1, 6, 7: 5 mA/PT Others: 6 mA/PT Total Max. 18 mA, 3 PTs	7 transistor sink outputs: 12 V DC, 0.5 A/PT resistive Total Max. 1A, 2 PTs Limited energy
	FC6A-C24R1AE	55°C	14 inputs: 24V DC, Input 0, 1, 6, 7: 5 mA/PT Others: 7 mA/PT	10 relay outputs: 240V AC / 30V DC, 2 A (GEN/RES) 7 A (Common)
		65°C	14 inputs: 24V DC, Input 0, 1, 6, 7: 5 mA/PT Others: 7 mA/PT Total Max. 45 mA, 7 PTs	10 relay outputs: 240V AC / 30V DC, 2 A (GEN/RES) 7 A (Common) Total Max. 10 A, 5 PTs
	FC6A-C24R1CE	55°C	14 inputs: 24V DC, Input 0, 1, 6, 7: 5 mA/PT Others: 7 mA/PT	10 relay outputs: 240V AC / 30V DC, 2 A (GEN/RES) 7 A (Common)
		65°C	14 inputs: 24V DC, Input 0, 1, 6, 7: 5 mA/PT Others: 7 mA/PT Total Max. 45 mA, 7 PTs	10 relay outputs: 240V AC / 30V DC, 2 A (GEN/RES) 7 A (Common) Total Max. 10 A, 5 PTs

Model Names	Type	Air Temp	Inputs	Outputs
All-in-One CPU module	FC6A-C24P1CE	55°C	14 inputs: 24V DC, Input 0, 1, 6, 7: 5 mA/PT Others: 7 mA/PT	10 transistor source outputs: 24V DC, 0.5 A/PT Class 2
		65°C	14 inputs: 24V DC, Input 0, 1, 6, 7: 5 mA/PT Others: 7 mA/PT Total Max. 27 mA, 5 PTs	10 transistor source outputs: 24V DC, 0.5 A/PT Class 2 Total Max. 2 A, 4 PTs
	FC6A-C24K1CE	55°C	14 inputs: 24V DC, Input 0, 1, 6, 7: 5 mA/PT Others: 7 mA/PT	10 transistor sink outputs: 24V DC, 0.5 A/PT
		65°C	14 inputs: 24V DC, Input 0, 1, 6, 7: 5 mA/PT Others: 7 mA/PT Total Max. 27 mA, 5 PTs	10 transistor sink outputs: 24V DC, 0.5 A/PT Total Max. 2 A, 4 PTs
	FC6A-C40R1AE	55°C	24 inputs: 24V DC, Input 0, 1, 6, 7: 5 mA/PT Others: 7 mA/PT	16 relay outputs: 240V AC / 30V DC, 2 A (GEN/RES) 7 A (Common)
		65°C	24 inputs: 24V DC, Input 0, 1, 6, 7: 5 mA/PT Others: 7 mA/PT Total Max. 80 mA, 12 PTs	16 relay outputs: 240V AC / 30V DC, 2 A (GEN/RES) 7 A (Common) Total Max. 16 A, 8 PTs
	FC6A-C40R1CE	55°C	24 inputs: 24V DC, Input 0, 1, 6, 7: 5 mA/PT Others: 7 mA/PT	16 relay outputs: 240V AC / 30V DC, 2 A (GEN/RES) 7 A (Common)
		65°C	24 inputs: 24V DC, Input 0, 1, 6, 7: 5 mA/PT Others: 7 mA/PT Total Max. 80 mA, 12 PTs	16 relay outputs: 240V AC / 30V DC, 2 A (GEN/RES) 7 A (Common) Total Max. 16 A, 8 PTs
	FC6A-C40P1CE	55°C	24 inputs: 24V DC, Input 0, 1, 6, 7: 5 mA/PT Others: 7 mA/PT	16 transistor source outputs: 24V DC, 0.5 A/PT Class 2
		65°C	24 inputs: 24V DC, Input 0, 1, 6, 7: 5 mA/PT Others: 7 mA/PT Total Max. 48 mA, 8 PTs	16 transistor source outputs: 24V DC, 0.5 A/PT Class 2 Total Max. 3 A, 6 PTs
	FC6A-C40K1CE	55°C	24 inputs: 24V DC, Input 0, 1, 6, 7: 5 mA/PT Others: 7 mA/PT	16 transistor sink outputs: 24V DC, 0.5 A/PT
		65°C	24 inputs: 24V DC, Input 0, 1, 6, 7: 5 mA/PT Others: 7 mA/PT Total Max. 48 mA, 8 PTs	16 transistor sink outputs: 24V DC, 0.5 A/PT Total Max. 3 A, 6 PTs
	FC6A-C40R1DE	55°C	24 inputs: 12V DC, Input 0, 1, 6, 7: 5 mA/PT Others: 6 mA/PT	16 relay outputs: 240V AC / 30V DC, 2 A (GEN/RES) 7 A (Common)
		65°C	24 inputs: 12V DC, Input 0, 1, 6, 7: 5 mA/PT Others: 6 mA/PT Total Max. 70 mA, 12 PTs	16 relay outputs: 240V AC / 30V DC, 2 A (GEN/RES) 7 A (Common) Total Max. 16 A, 8 PTs
	FC6A-C40P1DE	55°C	24 inputs: 12V DC, Input 0, 1, 6, 7: 5 mA/PT Others: 6 mA/PT	16 transistor source outputs: 12V DC, 0.5 A/PT Class 2
		65°C	24 inputs: 12V DC, Input 0, 1, 6, 7: 5 mA/PT Others: 6 mA/PT Total Max. 42 mA, 8 PTs	16 transistor source outputs: 12V DC, 0.5 A/PT Class 2 Total Max. 3 A, 6 PTs
FC6A-C40K1DE	55°C	24 inputs: 12V DC, Input 0, 1, 6, 7: 5 mA/PT Others: 6 mA/PT	16 transistor sink outputs: 12V DC, 0.5 A/PT	
	65°C	24 inputs: 12V DC, Input 0, 1, 6, 7: 5 mA/PT Others: 6 mA/PT Total Max. 42 mA, 8 PTs	16 transistor sink outputs: 12V DC, 0.5 A/PT Total Max. 3 A, 6 PTs	

2: PRODUCT SPECIFICATIONS

Model Names	Type	Air Temp	Inputs	Outputs	
CAN J1939 All-in-One CPU module	FC6A-C40R1AEJ	55°C	24 inputs: 24V DC, Input 0, 1, 6, 7: 5 mA/PT Others: 7 mA/PT	16 relay outputs: 240V AC / 30V DC, 2 A (GEN/RES) 7 A (Common)	
		65°C	24 inputs: 24V DC, Input 0, 1, 6, 7: 5 mA/PT Others: 7 mA/PT Total Max. 80 mA, 12 PTs	16 relay outputs: 240V AC / 30V DC, 2 A (GEN/RES) 7 A (Common) Total Max. 16 A, 8 PTs	
	FC6A-C40R1CEJ	55°C	24 inputs: 24V DC, Input 0, 1, 6, 7: 5 mA/PT Others: 7 mA/PT	16 relay outputs: 240V AC / 30V DC, 2 A (GEN/RES) 7 A (Common)	
		65°C	24 inputs: 24V DC, Input 0, 1, 6, 7: 5 mA/PT Others: 7 mA/PT Total Max. 80 mA, 12 PTs	16 relay outputs: 240V AC / 30V DC, 2 A (GEN/RES) 7 A (Common) Total Max. 16 A, 8 PTs	
	FC6A-C40P1CEJ	55°C	24 inputs: 24V DC, Input 0, 1, 6, 7: 5 mA/PT Others: 7 mA/PT	16 transistor source outputs: 24V DC, 0.5 A/PT Class 2	
		65°C	24 inputs: 24V DC, Input 0, 1, 6, 7: 5 mA/PT Others: 7 mA/PT Total Max. 48 mA, 8 PTs	16 transistor source outputs: 24V DC, 0.5 A/PT Class 2 Total Max. 3 A, 6 PTs	
	FC6A-C40K1CEJ	55°C	24 inputs: 24V DC, Input 0, 1, 6, 7: 5 mA/PT Others: 7 mA/PT	16 transistor sink outputs: 24V DC, 0.5 A/PT	
		65°C	24 inputs: 24V DC, Input 0, 1, 6, 7: 5 mA/PT Others: 7 mA/PT Total Max. 48 mA, 8 PTs	16 transistor sink outputs: 24V DC, 0.5 A/PT Total Max. 3 A, 6 PTs	
	FC6A-C40R1DEJ	55°C	24 inputs: 12V DC, Input 0, 1, 6, 7: 5 mA/PT Others: 6 mA/PT	16 relay outputs: 240V AC / 30V DC, 2 A (GEN/RES) 7 A (Common)	
		65°C	24 inputs: 12V DC, Input 0, 1, 6, 7: 5 mA/PT Others: 6 mA/PT Total Max. 70 mA, 12 PTs	16 relay outputs: 240V AC / 30V DC, 2 A (GEN/RES) 7 A (Common) Total Max. 16 A, 8 PTs	
	FC6A-C40P1DEJ	55°C	24 inputs: 12V DC, Input 0, 1, 6, 7: 5 mA/PT Others: 6 mA/PT	16 transistor source outputs: 12V DC, 0.5 A/PT Class 2	
		65°C	24 inputs: 12V DC, Input 0, 1, 6, 7: 5 mA/PT Others: 6 mA/PT Total Max. 42 mA, 8 PTs	16 transistor source outputs: 12V DC, 0.5 A/PT Class 2 Total Max. 3 A, 6 PTs	
	FC6A-C40K1DEJ	55°C	24 inputs: 12V DC, Input 0, 1, 6, 7: 5 mA/PT Others: 6 mA/PT	16 transistor sink outputs: 12V DC, 0.5 A/PT	
		65°C	24 inputs: 12V DC, Input 0, 1, 6, 7: 5 mA/PT Others: 6 mA/PT Total Max. 42 mA, 8 PTs	16 transistor sink outputs: 12V DC, 0.5 A/PT Total Max. 3 A, 6 PTs	
	Plus CPU module	FC6A-D16R1CEE	55°C	8 inputs: 24V DC, Input 0, 1, 3, 4, 6, 7: 5 mA/PT Others: 7 mA/PT	8 relay outputs: 240V AC / 30V DC, 2 A (GEN/RES) 7 A (Common); D300, 2 A 30V AC, 180 VA 120/240V AC, R300, 1 A 30V DC, 28 VA 125/250V DC pilot duty
			65°C	8 inputs: 24V DC, Input 0, 1, 3, 4, 6, 7: 5 mA/PT Others: 7 mA/PT Total Max. 22 mA, 4 PTs	8 relay outputs: 240V AC / 30V DC, 2 A (GEN/RES) 7 A (Common); D300, 2 A 30V AC, 180 VA 120/240V AC, R300, 1 A 30V DC, 28 VA 125/250V DC pilot duty Total Max. 8 A, 4 PTs
FC6A-D16R4CEE		55°C	8 inputs: 24V DC, Input 0, 1, 3, 4, 6, 7: 5 mA/PT Others: 7 mA/PT	8 relay outputs: 240V AC / 30V DC, 2 A (GEN/RES) 7 A (Common); D300, 2 A 30V AC, 180 VA 120/240V AC, R300, 1 A 30V DC, 28 VA 125/250V DC pilot duty	
		65°C	8 inputs: 24V DC, Input 0, 1, 3, 4, 6, 7: 5 mA/PT Others: 7 mA/PT Total Max. 22 mA, 4 PTs	8 relay outputs: 240V AC / 30V DC, 2 A (GEN/RES) 7 A (Common); D300, 2 A 30V AC, 180 VA 120/240V AC, R300, 1 A 30V DC, 28 VA 125/250V DC pilot duty Total Max. 8 A, 4 PTs	

Model Names	Type	Air Temp	Inputs	Outputs
Plus CPU module	FC6A-D16P1CEE	55°C	8 inputs: 24V DC, Input 0, 1, 3, 4, 6, 7: 5 mA/PT Others: 7 mA/PT Total Max. 26.4 mA	8 transistor source outputs: 24V DC, 0.5 A/PT resistive Total Max. 3.2 A, Limited energy
		65°C	8 inputs: 24V DC, Input 0, 1, 3, 4, 6, 7: 5 mA/PT Others: 7 mA/PT Total Max. 10 mA, 2 PTs	8 transistor source outputs: 24V DC, 0.5 A/PT resistive Total Max. 1 A, 2 PTs, Limited energy
	FC6A-D16P4CEE	55°C	8 inputs: 24V DC, Input 0, 1, 3, 4, 6, 7: 5 mA/PT Others: 7 mA/PT Total Max. 26.4 mA	8 transistor source outputs: 24V DC, 0.5 A/PT resistive Total Max. 3.2 A, Limited energy
		65°C	8 inputs: 24V DC, Input 0, 1, 3, 4, 6, 7: 5 mA/PT Others: 7 mA/PT Total Max. 10 mA, 2 PTs	8 transistor source outputs: 24V DC, 0.5 A/PT resistive Total Max. 1 A, 2 PTs, Limited energy
	FC6A-D16K1CEE	55°C	8 inputs: 24V DC, Input 0, 1, 3, 4, 6, 7: 5 mA/PT Others: 7 mA/PT Total Max. 26.4 mA	8 transistor sink outputs: 24V DC, 0.5 A/PT resistive Total Max. 3.2 A, Limited energy
		65°C	8 inputs: 24V DC, Input 0, 1, 3, 4, 6, 7: 5 mA/PT Others: 7 mA/PT Total Max. 10 mA, 2 PTs	8 transistor sink outputs: 24V DC, 0.5 A/PT resistive Total Max. 1 A, 2 PTs, Limited energy
	FC6A-D16K4CEE	55°C	8 inputs: 24V DC, Input 0, 1, 3, 4, 6, 7: 5 mA/PT Others: 7 mA/PT Total Max. 26.4 mA	8 transistor sink outputs: 24V DC, 0.5 A/PT resistive Total Max. 3.2 A, Limited energy
		65°C	8 inputs: 24V DC, Input 0, 1, 3, 4, 6, 7: 5 mA/PT Others: 7 mA/PT Total Max. 10 mA, 2 PTs	8 transistor sink outputs: 24V DC, 0.5 A/PT resistive Total Max. 1 A, 2 PTs, Limited energy
	FC6A-D32P3CEE	55°C	16 inputs: 24V DC, Input 0, 1, 3, 4, 6, 7: 5 mA/PT Others: 7 mA/PT Total Max. 60.0 mA	16 transistor source outputs: 24V DC, 0.1 A/PT resistive Total Max. 1.28 A, Limited energy
		65°C	16 inputs: 24V DC, Input 0, 1, 3, 4, 6, 7: 5 mA/PT Others: 7 mA/PT Total Max. 21 mA	16 transistor source outputs: 24V DC, 0.1 A/PT resistive Total Max. 0.4 A, Limited energy
	FC6A-D32P4CEE	55°C	16 inputs: 24V DC, Input 0, 1, 3, 4, 6, 7: 5 mA/PT Others: 7 mA/PT Total Max. 60.0 mA	16 transistor source outputs: 24V DC, 0.1 A/PT resistive Total Max. 1.28 A, Limited energy
		65°C	16 inputs: 24V DC, Input 0, 1, 3, 4, 6, 7: 5 mA/PT Others: 7 mA/PT Total Max. 21 mA	16 transistor source outputs: 24V DC, 0.1 A/PT resistive Total Max. 0.4 A, Limited energy
	FC6A-D32K3CEE	55°C	16 inputs: 24V DC, Input 0, 1, 3, 4, 6, 7: 5 mA/PT Others: 7 mA/PT Total Max. 60.0 mA	16 transistor sink outputs: 24V DC, 0.1 A/PT resistive Total Max. 1.28 A
		65°C	16 inputs: 24V DC, Input 0, 1, 3, 4, 6, 7: 5 mA/PT Others: 7 mA/PT Total Max. 21 mA	16 transistor sink outputs: 24V DC, 0.1 A/PT resistive Total Max. 0.4 A
	FC6A-D32K4CEE	55°C	16 inputs: 24V DC, Input 0, 1, 3, 4, 6, 7: 5 mA/PT Others: 7 mA/PT Total Max. 60.0 mA	16 transistor sink outputs: 24V DC, 0.1 A/PT resistive Total Max. 1.28 A
		65°C	16 inputs: 24V DC, Input 0, 1, 3, 4, 6, 7: 5 mA/PT Others: 7 mA/PT Total Max. 21 mA	16 transistor sink outputs: 24V DC, 0.1 A/PT resistive Total Max. 0.4 A

2: PRODUCT SPECIFICATIONS

Model Names	Type	Air Temp	Inputs	Outputs
Digital I/O module	FC6A-N08B1/ FC6A-N08B4	55°C	8 inputs: 24V DC, 7 mA/PT	-
		65°C	8 inputs: 24V DC, 7 mA/PT Total Max. 28 mA, 4 PTs	-
	FC6A-N16B1/ FC6A-N16B4	55°C	16 inputs, 24V DC, 7 mA/PT Total max. 123.2 mA	-
		65°C	16 inputs: 24V DC, 7 mA/PT Total Max. 56 mA 8 PTs	-
	FC6A-N16B3	55°C	16 inputs: 24V DC, 5 mA/PT Total Max. 72 mA	-
		65°C	16 inputs: 24V DC, 5 mA/PT Total Max. 35 mA, 7 PTs	-
	FC6A-N32B3	55°C	32 inputs: 24V DC, 5 mA/PT Total Max. 144 mA	-
		65°C	32 inputs: 24V DC, 5 mA/PT Total Max. 70 mA, 14 PTs	-
	FC6A-N08A11/ FC6A-N08A14	55°C	8 inputs: 120V AC, 50/60 Hz, 15 mA/PT	-
		65°C	8 inputs: 120V AC, 50/60 Hz, 15 mA/PT Total Max. 60 mA, 4 PTs	-
	FC6A-R081/ FC6A-R084	55°C	-	8 relay outputs: 240V AC/30V DC, 2 A (GEN/RES) 7 A/Common
		65°C	-	8 relay outputs: 240V AC/30V DC, 2 A (GEN/RES) 7 A/Common Total Max. 8 A, 4 PTs
	FC6A-R161/ FC6A-R164	55°C	-	16 relay outputs: 240V AC/30V DC, 2 A (GEN/RES) 8 A/Common
		65°C	-	16 relay outputs: 240V AC/30V DC, 2 A (GEN/RES) 8 A/Common Total Max. 16 A, 8 PTs
	FC6A-T08P1/ FC6A-T08P4	55°C	-	8 transistor source outputs: 24V DC, 0.5 A/PT Class 2
		65°C	-	8 transistor source outputs: 24V DC, 0.5 A/PT Class 2 Total Max. 2 A, 4 PTs
	FC6A-T16P1/ FC6A-T16P4	55°C	-	16 transistor source outputs: 24V DC, 0.5 A/PT Class 2
		65°C	-	16 transistor source outputs: 24V DC, 0.5 A/PT Class 2 Total Max. 4 A, 8 PTs
	FC6A-T16P3	55°C	-	16 transistor source outputs: 24V DC, 0.1 A/PT Class 2
		65°C	-	16 transistor source outputs: 24V DC, 0.1 A/PT Class 2 Total Max. 0.8 A, 8 PTs
FC6A-T32P3	55°C	-	32 transistor source outputs: 24V DC, 0.1 A/PT Class 2	
	65°C	-	32 transistor source outputs: 24V DC, 0.1 A/PT Class 2 Total Max. 1.6 A, 16 PTs	

Model Names	Type	Air Temp	Inputs	Outputs
Digital I/O module	FC6A-T08K1/ FC6A-T08K4	55°C	-	8 transistor sink outputs: 24V DC, 0.5 A/PT Class 2
		65°C	-	8 transistor sink outputs: 24V DC, 0.5 A/PT Class 2 Total Max. 2 A, 4 PTs
	FC6A-T16K1/ FC6A-T16K4	55°C	-	16 transistor sink outputs: 24V DC, 0.5 A/PT Class 2
		65°C	-	16 transistor sink outputs: 24V DC, 0.5 A/PT Class 2 Total Max. 4 A, 8 PTs
	FC6A-T16K3	55°C	-	16 transistor sink outputs: 24V DC, 0.1 A/PT Class 2
		65°C	-	16 transistor sink outputs: 24V DC, 0.1 A/PT Class 2 Total Max. 0.8 A, 8 PTs
	FC6A-T32K3	55°C	-	32 transistor sink outputs: 24V DC, 0.1 A/PT Class 2
		65°C	-	32 transistor sink outputs: 24V DC, 0.1 A/PT Class 2 Total Max. 1.6 A, 16 PTs
	FC6A-M08BR1/ FC6A-M08BR4	55°C	4 inputs: 24V DC, 7 mA/PT	4 relay outputs: 240V AC/30V DC, 2 A (GEN/RES) 7 A/Common
		65°C	4 inputs: 24V DC, 7 mA/PT Total Max. 14 mA, 2 PTs	4 relay outputs: 240V AC/30V DC, 2 A (GEN/RES) 7 A/Common Total Max. 4 A, 2 PTs
	FC6A-M24BR1/ FC6A-M24BR4	55°C	16 inputs: 24V DC, 7 mA/PT Total Max. 123.2 mA	8 relay outputs: 240V AC/30V DC, 2 A (GEN/RES) 7 A/Common
		65°C	16 inputs: 24V DC, 7 mA/PT Total Max. 56 mA, 8 PTs	8 relay outputs: 240V AC/30V DC, 2 A (GEN/RES) 7 A/Common Total Max. 8 A, 4 PTs
Analog I/O module	FC6A-J2C1/ FC6A-J2C4	55°C	2 analog inputs	-
		65°C	2 analog inputs	-
	FC6A-J4A1/ FC6A-J4A4	55°C	4 analog inputs	-
		65°C	4 analog inputs	-
	FC6A-J8A1/ FC6A-J8A4	55°C	8 analog inputs	-
		65°C	8 analog inputs	-
	FC6A-L03CN1/ FC6A-L03CN4	55°C	2 analog inputs	1 analog output, Class 2
		65°C	2 analog inputs	1 analog voltage output only, Class 2
	FC6A-J4CN1/ FC6A-J4CN4	55°C	4 analog inputs	-
		65°C	4 analog inputs	-
	FC6A-K2A1/ FC6A-K2A4	55°C	-	2 analog outputs, Class 2
		65°C	-	2 analog outputs, Class 2
	FC6A-J8CU1/ FC6A-J8CU4	55°C	8 analog inputs	-
		65°C	8 analog inputs	-
FC6A-J4CH1Y/ FC6A-J4CH4Y	55°C	4 analog inputs	-	
	65°C	4 analog inputs	-	

2: PRODUCT SPECIFICATIONS

Model Names	Type	Air Temp	Inputs	Outputs	
Expansion interface module	FC6A-EXM1M	55°C	-	-	
		65°C	-	-	
	FC6A-EXM1S	55°C	-	-	
		65°C	-	-	
	FC6A-EXM1S4	55°C	-	-	
		65°C	-	-	
	FC6A-EXM2	55°C	-	-	
		65°C	-	-	
	FC6A-EXM24	55°C	-	-	
		65°C	-	-	
	Communication module	FC6A-SIF52	55°C	-	-
			65°C	-	-
FC6A-SIF524		55°C	-	-	
		65°C	-	-	
FC6B series	FC6B-D16K1C	55°C	8 inputs: 24V DC, Input 0, 1, 6, 7: 5mA/PT Others : 7 mA/PT Total Max. 28.8 mA	8 transistor sink outputs: 24V DC, 0.5 A/PT resistive Total Max. 3.2 A, Limited energy	
		65°C	8 inputs: 24V DC, Input 0, 1, 6, 7: 5 mA/PT Others : 7 mA/PT Total Max. 10 mA, 2 PTs	8 transistor sink outputs: 24V DC, 0.5 A/PT resistive Total Max. 1 A, 2 PTs, Limited energy	
	FC6B-D16K4C	55°C	8 inputs: 24V DC, Input 0, 1, 6, 7: 5mA/PT Others : 7 mA/PT Total Max. 28.8 mA	8 transistor sink outputs: 24V DC, 0.5 A/PT resistive Total Max. 3.2 A, Limited energy	
		65°C	8 inputs: 24V DC, Input 0, 1, 6, 7: 5 mA/PT Others : 7 mA/PT Total Max. 10 mA, 2 PTs	8 transistor sink outputs: 24V DC, 0.5 A/PT resistive Total Max. 1 A, 2 PTs, Limited energy	
	FC6B-D16P1C	55°C	8 inputs: 24V DC, Input 0, 1, 6, 7: 5 mA/PT Others : 7 mA/PT Total Max. 28.8 mA	8 transistor source outputs: 24V DC, 0.5 A/PT resistive Total Max. 3.2 A, Limited energy	
		65°C	8 inputs: 24V DC, Input 0, 1, 6, 7: 5mA/PT Others : 7 mA/PT Total Max. 10 mA, 2 PTs	8 transistor source outputs: 24V DC, 0.5 A/PT resistive Total Max. 1 A, 2 PTs, Limited energy	
	FC6B-D16P4C	55°C	8 inputs: 24V DC, Input 0, 1, 6, 7: 5 mA/PT Others : 7 mA/PT Total Max. 28.8 mA	8 transistor source outputs: 24V DC, 0.5 A/PT resistive Total Max. 3.2 A, Limited energy	
		65°C	8 inputs: 24V DC, Input 0, 1, 6, 7: 5mA/PT Others : 7 mA/PT Total Max. 10 mA, 2 PTs	8 transistor source outputs: 24V DC, 0.5 A/PT resistive Total Max. 1 A, 2 PTs, Limited energy	
	FC6B-D16R1C	55°C	8 inputs: 24V DC, Input 0, 1, 6, 7: 5 mA/PT Others : 7 mA/PT	8 relay outputs: 240V AC / 30V DC, 2 A (GEN/RES), 7 A (Common) D300, 2 A 30V AC, 180 VA 120/240V AC, R300, 1 A 30V DC, 28 VA 125/250V DC pilot duty	
		65°C	8 inputs: 24V DC, Input 0, 1, 6, 7: 5 mA/PT Others : 7 mA/PT Total Max. 24 mA, 4 PTs	8 relay outputs: 240V AC / 30V DC, 2 A (GEN/RES), 7 A (Common) D300, 2 A 30V AC, 180 VA 120/240V AC, R300, 1 A 30V DC, 28 VA 125/250V DC pilot duty Total Max. 8 A, 4 PTs	
	FC6B-D16R4C	55°C	8 inputs: 24V DC, Input 0, 1, 6, 7: 5 mA/PT Others : 7 mA/PT	8 relay outputs: 240V AC / 30V DC, 2 A (GEN/RES), 7 A (Common) D300, 2 A 30V AC, 180 VA 120/240V AC, R300, 1 A 30V DC, 28 VA 125/250V DC pilot duty	
		65°C	8 inputs: 24V DC, Input 0, 1, 6, 7: 5 mA/PT Others : 7 mA/PT Total Max. 24 mA, 4 PTs	8 relay outputs: 240V AC / 30V DC, 2 A (GEN/RES), 7 A (Common) D300, 2 A 30V AC, 180 VA 120/240V AC, R300, 1 A 30V DC, 28 VA 125/250V DC pilot duty Total Max. 8 A, 4 PTs	

Model Names	Type	Air Temp	Inputs	Outputs
FC6B series	FC6B-D32K3C	55°C	16 inputs: 24V DC, Input 0, 1, 6, 7: 5 mA/PT Others: 7 mA/PT Total Max. 62.4 mA	16 transistor sink outputs: 24V DC, 0.1 A/PT resistive Total Max. 1.28 A, Limited energy
		65°C	16 inputs: 24V DC, Input 0, 1, 6, 7: 5 mA/PT Others: 7 mA/PT Total Max. 21 mA, 3 PTs	16 transistor sink outputs: 24V DC, 0.1 A/PT resistive Total Max. 0.4 A, 4 PTs, Limited energy
	FC6B-D32K4C	55°C	16 inputs: 24V DC, Input 0, 1, 6, 7: 5 mA/PT Others: 7 mA/PT Total Max. 62.4 mA	16 transistor sink outputs: 24V DC, 0.1 A/PT resistive Total Max. 1.28 A, Limited energy
		65°C	16 inputs: 24V DC, Input 0, 1, 6, 7: 5 mA/PT Others: 7 mA/PT Total Max. 21 mA, 3 PTs	16 transistor sink outputs: 24V DC, 0.1 A/PT resistive Total Max. 0.4 A, 4 PTs, Limited energy
	FC6B-D32P3C	55°C	16 inputs: 24V DC, Input 0, 1, 6, 7: 5 mA/PT Others: 7 mA/PT Total Max. 62.4 mA	16 transistor source outputs: 24V DC, 0.1 A/PT resistive Total Max. 1.28 A, Limited energy
		65°C	16 inputs: 24V DC, Input 0, 1, 6, 7: 5 mA/PT Others: 7 mA/PT Total Max. 21 mA, 3 PTs	16 transistor source outputs: 24V DC, 0.1 A/PT resistive Total Max. 0.4 A, 4 PTs, Limited energy
	FC6B-D32P4C	55°C	16 inputs: 24V DC, Input 0, 1, 6, 7: 5 mA/PT Others: 7 mA/PT Total Max. 62.4 mA	16 transistor source outputs: 24V DC, 0.1 A/PT resistive Total Max. 1.28 A, Limited energy
		65°C	16 inputs: 24V DC, Input 0, 1, 6, 7: 5 mA/PT Others: 7 mA/PT Total Max. 21 mA, 3 PTs	16 transistor source outputs: 24V DC, 0.1 A/PT resistive Total Max. 0.4 A, 4 PTs, Limited energy
	FC6B-C16R1A	55°C	9 inputs: 24V DC, Input 0, 1, 6, 7: 5 mA/PT Others: 7 mA/PT	7 relay outputs: 240V AC / 30V DC, 2 A (GEN/RES) 7 A (Common)
		65°C	9 inputs: 24V DC, Input 0, 1, 6, 7: 5 mA/PT Others: 7 mA/PT Total Max. 28 mA, 4 PTs	7 relay outputs: 240V AC / 30V DC, 2 A (GEN/RES) 7 A (Common) Total Max. 6 A, 3 PTs
	FC6B-C16R1C	55°C	9 inputs: 24V DC, Input 0, 1, 6, 7: 5 mA/PT Others: 7 mA/PT	7 relay outputs: 240V AC / 30V DC, 2 A (GEN/RES) 7 A (Common)
		65°C	9 inputs: 24V DC, Input 0, 1, 6, 7: 5 mA/PT Others: 7 mA/PT Total Max. 28 mA, 4 PTs	7 relay outputs: 240V AC / 30V DC, 2 A (GEN/RES) 7 A (Common) Total Max. 6 A, 3 PTs
	FC6B-C16P1C	55°C	9 inputs: 24V DC, Input 0, 1, 6, 7: 5 mA/PT Others: 7 mA/PT	7 transistor source outputs: 24V DC, 0.5 A/PT Class 2
		65°C	9 inputs: 24V DC, Input 0, 1, 6, 7: 5 mA/PT Others: 7 mA/PT Total Max. 17 mA, 3 PTs	7 transistor source outputs: 24V DC, 0.5 A/PT Class 2 Total Max. 1 A, 2 PTs
	FC6B-C16K1C	55°C	9 inputs: 24V DC, Input 0, 1, 6, 7: 5 mA/PT Others: 7 mA/PT	7 transistor sink outputs: 24V DC, 0.5 A/PT Class 2
		65°C	9 inputs: 24V DC, Input 0, 1, 6, 7: 5 mA/PT Others: 7 mA/PT Total Max. 17 mA, 3 PTs	7 transistor sink outputs: 24V DC, 0.5 A/PT Class 2 Total Max. 1 A, 2 PTs
FC6B-C24R1A	55°C	14 inputs: 24V DC, Input 0, 1, 6, 7: 5 mA/PT Others: 7 mA/PT	10 relay outputs: 240V AC / 30V DC, 2 A (GEN/RES) 7 A (Common)	
	65°C	14 inputs: 24V DC, Input 0, 1, 6, 7: 5 mA/PT Others: 7 mA/PT Total Max. 45 mA, 7 PTs	10 relay outputs: 240V AC / 30V DC, 2 A (GEN/RES) 7 A (Common) Total Max. 10 A, 5 PTs	

2: PRODUCT SPECIFICATIONS

Model Names	Type	Air Temp	Inputs	Outputs
FC6B series	FC6B-C24R1C	55°C	14 inputs: 24V DC, Input 0, 1, 6, 7: 5 mA/PT Others: 7 mA/PT	10 relay outputs: 240V AC / 30V DC, 2 A (GEN/RES) 7 A (Common)
		65°C	14 inputs: 24V DC, Input 0, 1, 6, 7: 5 mA/PT Others: 7 mA/PT Total Max. 45 mA, 7 PTs	10 relay outputs: 240V AC / 30V DC, 2 A (GEN/RES) 7 A (Common) Total Max. 10 A, 5 PTs
	FC6B-C24P1C	55°C	14 inputs: 24V DC, Input 0, 1, 6, 7: 5 mA/PT Others: 7 mA/PT	10 transistor source outputs: 24V DC, 0.5 A/PT Class 2
		65°C	14 inputs: 24V DC, Input 0, 1, 6, 7: 5 mA/PT Others: 7 mA/PT Total Max. 27 mA, 5 PTs	10 transistor source outputs: 24V DC, 0.5 A/PT Class 2 Total Max. 2 A, 4 PTs
	FC6B-C24K1C	55°C	14 inputs: 24V DC, Input 0, 1, 6, 7: 5 mA/PT Others: 7 mA/PT	10 transistor sink outputs: 24V DC, 0.5 A/PT Class 2
		65°C	14 inputs: 24V DC, Input 0, 1, 6, 7: 5 mA/PT Others: 7 mA/PT Total Max. 27 mA, 5 PTs	10 transistor sink outputs: 24V DC, 0.5 A/PT Class 2 Total Max. 2 A, 4 PTs
	FC6B-C40R1A	55°C	24 inputs: 24V DC, Input 0, 1, 6, 7: 5 mA/PT Others: 7 mA/PT	16 relay outputs: 240V AC / 30V DC, 2 A (GEN/RES) 7 A (Common)
		65°C	24 inputs: 24V DC, Input 0, 1, 6, 7: 5 mA/PT Others: 7 mA/PT Total Max. 80 mA, 12 PTs	16 relay outputs: 240V AC / 30V DC, 2 A (GEN/RES) 7 A (Common) Total Max. 16 A, 8 PTs
	FC6B-C40R1C	55°C	24 inputs: 24V DC, Input 0, 1, 6, 7: 5 mA/PT Others: 7 mA/PT	16 relay outputs: 240V AC / 30V DC, 2 A (GEN/RES) 7 A (Common)
		65°C	24 inputs: 24V DC, Input 0, 1, 6, 7: 5 mA/PT Others: 7 mA/PT Total Max. 80 mA, 12 PTs	16 relay outputs: 240V AC / 30V DC, 2 A (GEN/RES) 7 A (Common) Total Max. 16 A, 8 PTs
	FC6B-C40P1C	55°C	24 inputs: 24V DC, Input 0, 1, 6, 7: 5 mA/PT Others: 7 mA/PT	16 transistor source outputs: 24V DC, 0.5 A/PT Class 2
		65°C	24 inputs: 24V DC, Input 0, 1, 6, 7: 5 mA/PT Others: 7 mA/PT Total Max. 48 mA, 8 PTs	16 transistor source outputs: 24V DC, 0.5 A/PT Class 2 Total Max. 3 A, 6 PTs
	FC6B-C40K1C	55°C	24 inputs: 24V DC, Input 0, 1, 6, 7: 5 mA/PT Others: 7 mA/PT	16 transistor sink outputs: 24V DC, 0.5 A/PT Class 2
		65°C	24 inputs: 24V DC, Input 0, 1, 6, 7: 5 mA/PT Others: 7 mA/PT Total Max. 48 mA, 8 PTs	16 transistor sink outputs: 24V DC, 0.5 A/PT Class 2 Total Max. 3 A, 6 PTs

The following products can be used at Max Surrounding Air Temperature of 55°C only.

The input/output ratings of the following products at Max Surrounding Air Temperature of 55°C are as follows.

Model Names	Type	Air Temp	Inputs	Outputs
Analog I/O module	FC6A-K4A1/ FC6A-K4A4	55°C	-	4 analog outputs, Class 2
	FC6A-L06A1/ FC6A-L06A4	55°C	-	2 analog outputs, Class 2
	FC6A-F2M1/ FC6A-F2M4	55°C	2 analog inputs	2 analog outputs or digital output, Class 2
	FC6A-F2MR1/ FC6A-F2MR4	55°C	2 analog inputs	2 relay outputs: 250V AC/30V DC, 5 A (RES), 3 A (GEN)
HMI module	FC6A-PH1	55°C	-	-
Cartridge base module	FC6A-HPH1	55°C	-	-
Analog I/O cartridge	FC6A-PJ2A	55°C	2 analog inputs	-
	FC6A-PJ2CP	55°C	2 analog inputs	-
	FC6A-PK2AV	55°C	-	2 analog outputs
	FC6A-PK2AW	55°C	-	2 analog outputs
Communication cartridge	FC6A-PC1	55°C	-	-
	FC6A-PC3	55°C	-	-
	FC6A-PC4	55°C	-	-
Digital I/O cartridge	FC6A-PTK4	55°C	-	4 transistor source outputs: 24V DC, 0.1 A/PT resistive 12V DC, 0.1 A/PT resistive Limited energy
	FC6A-PTS4	55°C	-	4 transistor source outputs: 24V DC, 0.1 A/PT resistive 12V DC, 0.1 A/PT resistive Limited energy
	FC6A-PN4	55°C	4 inputs: 24V DC, 5 mA/PT 12V DC, 2.5 mA/PT	-

3: INSTALLATION AND WIRING

Introduction

This chapter describes the methods and precautions for installing and wiring FC6A Series MICROSmart modules.

Before starting installation and wiring, be sure to read "Safety Precautions" in the beginning of this manual and understand precautions described under Warning and Caution.

This section describes the precautions when installing and wiring the FC6A Series MICROSmart.



Warning

- Turn off the power to the FC6A Series MICROSmart before starting installation, removal, wiring, maintenance, and inspection of the FC6A Series MICROSmart. Failure to turn power off may cause electrical shocks or fire hazard.
- Emergency stop and interlocking circuits must be configured outside the FC6A Series MICROSmart. If such a circuit is configured inside the FC6A Series MICROSmart, failure of the FC6A Series MICROSmart may cause disorder of the control system, damage, or accidents.
- Special expertise is required to install, wire, program, and operate the FC6A Series MICROSmart. People without such expertise must not use the FC6A Series MICROSmart.



Caution

- Prevent metal fragments and pieces of wire from dropping inside the FC6A Series MICROSmart housing. Put a cover on the FC6A Series MICROSmart modules during installation and wiring. Ingress of such fragments and chips may cause fire hazard, damage, or malfunction.
- Do not touch the connector pins with your hand. Electrostatic discharge may damage the internal elements.
- When handling the FC6A Series MICROSmart, take measures to discharge static electricity.
- Keep the FC6A Series MICROSmart wiring away from motor lines.
- Wire the connectors and terminal blocks so that no force is applied to them.

Installation Location

The FC6A Series MICROSmart is designed to be installed in control panels and similar locations.

Install the FC6A Series MICROSmart within product specifications.

Avoid use in the environments below, as doing so may cause electric shock, fire, or malfunction:

Places where there is a lot of dust, salt, iron powder, or soot.

Places exposed to direct sunlight.

Places where the FC6A Series MICROSmart may be exposed to vibration or shock, either directly or indirectly.

Atmospheres of corrosive or flammable gases.

Places where condensation may form.

Places where the FC6A Series MICROSmart may be directly exposed to water.

Around high-voltage lines, high-voltage equipment, motor lines, or motor equipment.

Places near where a large switching surge may occur.

Places subject to a strong magnetic or electrical field.

Mount the FC6A Series MICROSmart as follows. To provide ample ventilation, ensure that there is sufficient space between the FC6A Series MICROSmart and other devices, heat sources, and panel surfaces.

Normal Installation State

FC6A Series MICROSmart

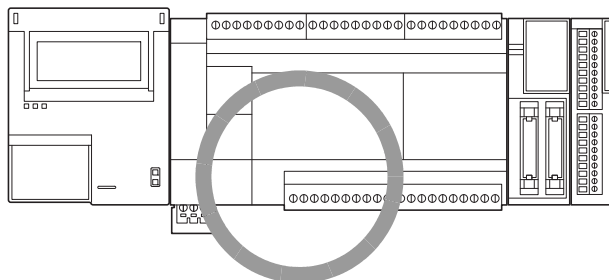

3: INSTALLATION AND WIRING

The FC6A Series MICROSmart can be mounted with the following orientation when the operating temperature is 35°C or lower.

Side Orientation (Use this orientation with an operating temperature of 35°C or lower.)

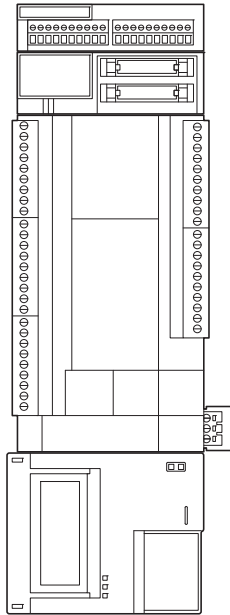

The FC6A Series MICROSmart cannot be mounted with the following orientations.

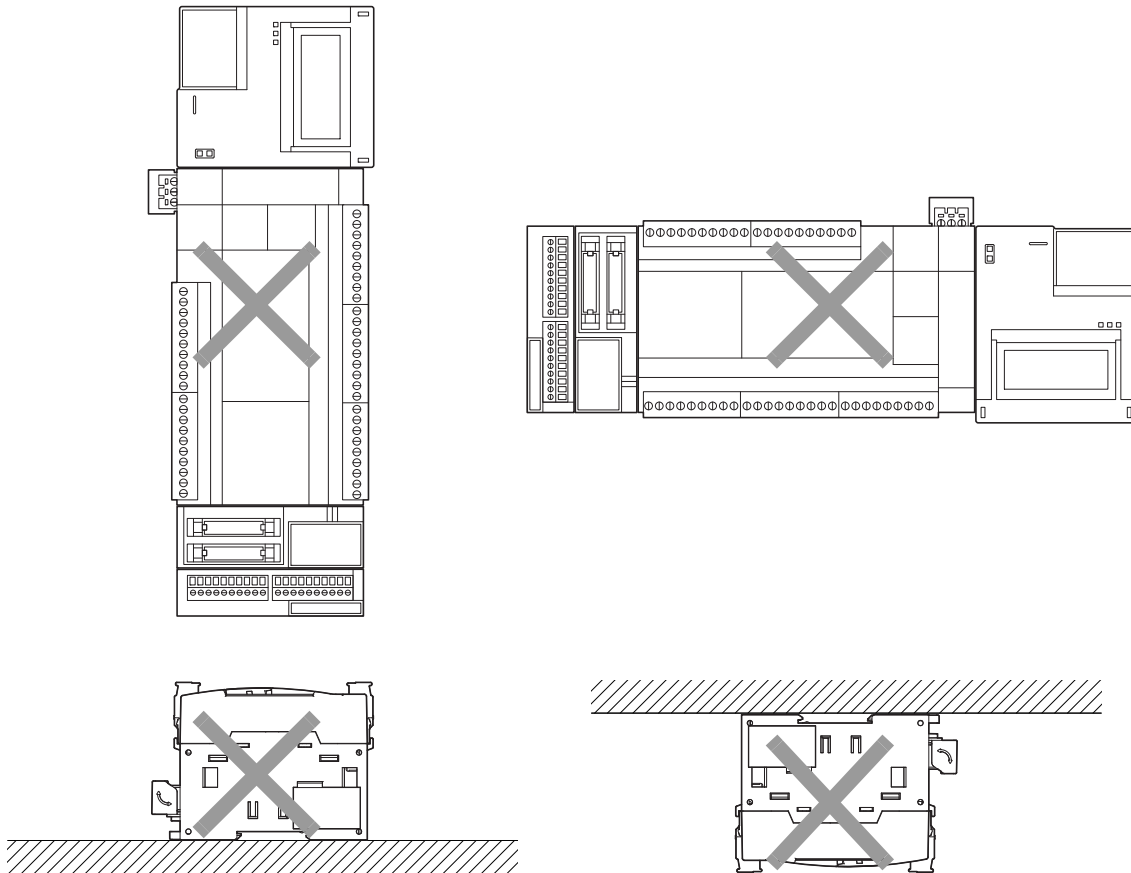

Mounting Space

To allow for heat dissipation and facilitate replacement, ensure that there are at least 20 to 40 mm between the FC6A Series MICROSmart and surrounding equipment and ducts.

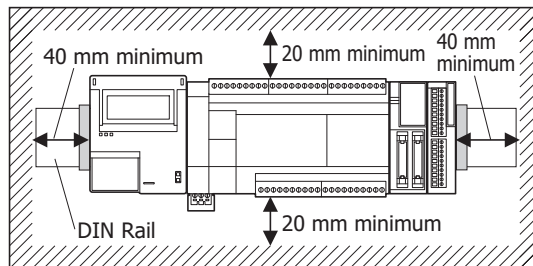

Mounting Two or More Units

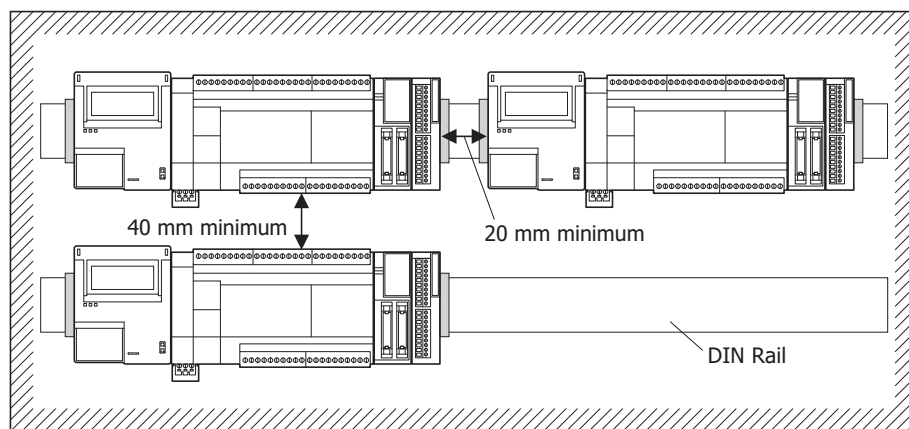

Assembly Methods

This section describes how to assemble the FC6A Series MICROSmart.



Caution

Assemble the FC6A Series MICROSmart before mounting it to a DIN rail or directly mounting it. When mounting the FC6A Series MICROSmart to a DIN rail, if it is assembled after being mounted to the DIN rail, there is a risk of damage.

Assembling the CPU Module and Expansion and Expansion Interface Modules

The following procedure describes the assembly of the CPU module and an expansion module.

1. Peel off the protection sticker applied to the expansion connector on the CPU module.

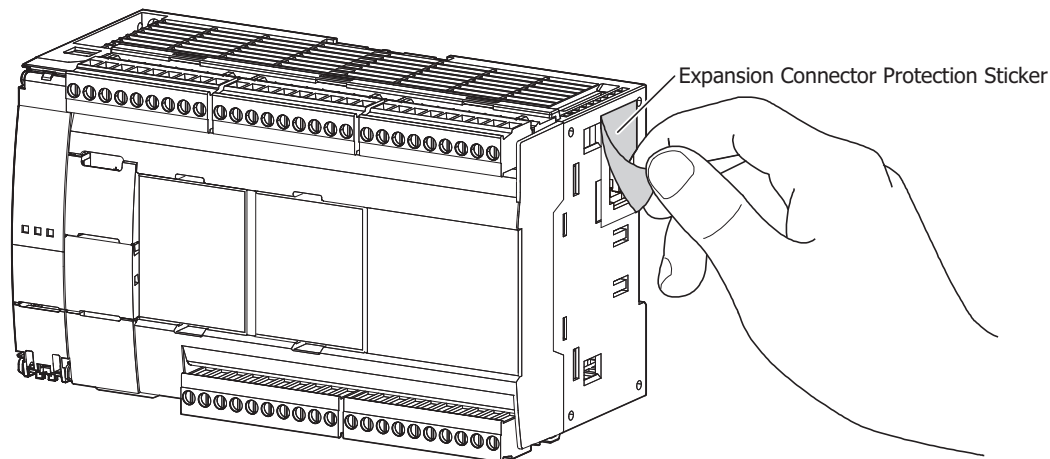

2. Line up the expansion module alongside the CPU module.

Note: The CPU module and the expansion module are easier to line up if you use the position of the expansion connector as a guide.

3. Confirm that the expansion module eject button is depressed and push the expansion module until it clicks while taking care with the position of the expansion connector. If the eject button is not depressed, push in the eject button until it clicks after the expansion module has been pushed onto the CPU module.

The expansion module is now locked on the CPU module.

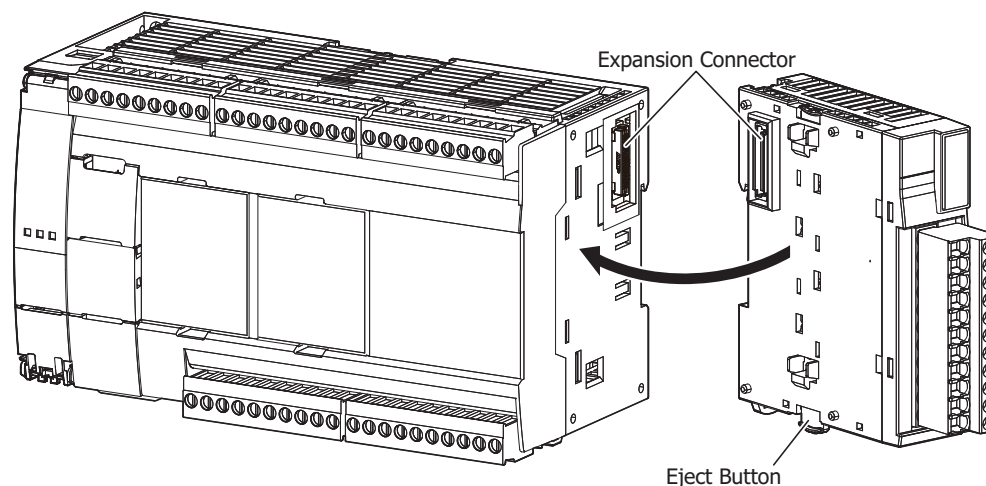

Caution

Do not perform this work when the FC6A Series MICROSmart is powered. Otherwise there is a risk of damage.

Note: The assembly of an expansion module and the expansion interface module is the same, first peel off the expansion connector protection sticker on the expansion module and then mount it.

Assembling the CPU Module and the HMI Module

The following procedure describes the assembly of the CPU module and the HMI module.

1. Peel off the protection sticker applied to the communication connector on the CPU module.

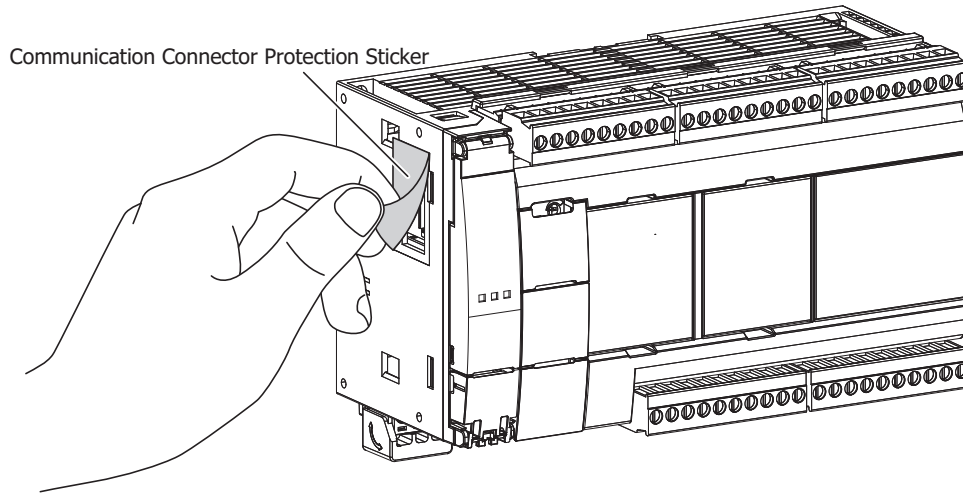

2. Line up the HMI module alongside the CPU module.

Note: The CPU module and the HMI module are easier to line up if you use the position of the communication connector as a guide.

3. Confirm that the HMI module eject button is depressed and push the HMI module until it clicks while taking care with the position of the communication connector. If the eject button is not depressed, push in the eject button until it clicks after the HMI module has been pushed onto the CPU module. The HMI module is now locked on the CPU module.

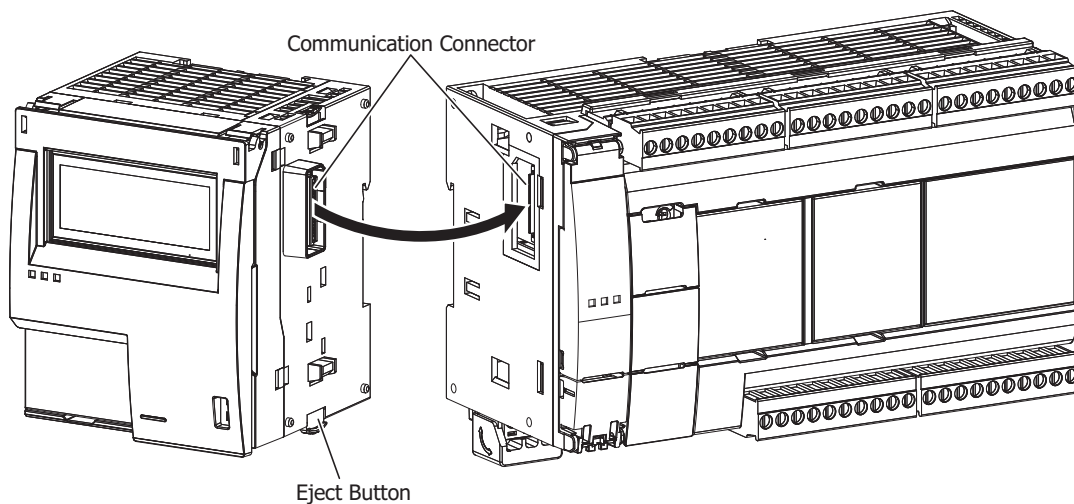

Caution Do not perform this work when the FC6A Series MICROSmart is powered. Otherwise there is a risk of damage.

Assembling the CPU Module and a Cartridge

The following procedure describes the assembly of the CPU module (cartridge slot 1) and an analog I/O cartridge.

1. Insert a flathead screwdriver into each of the screwdriver slots (two locations) on the CPU module (cartridge slot 1) and remove the dummy cartridge straight off the CPU module by pushing down the dummy cartridge tabs.

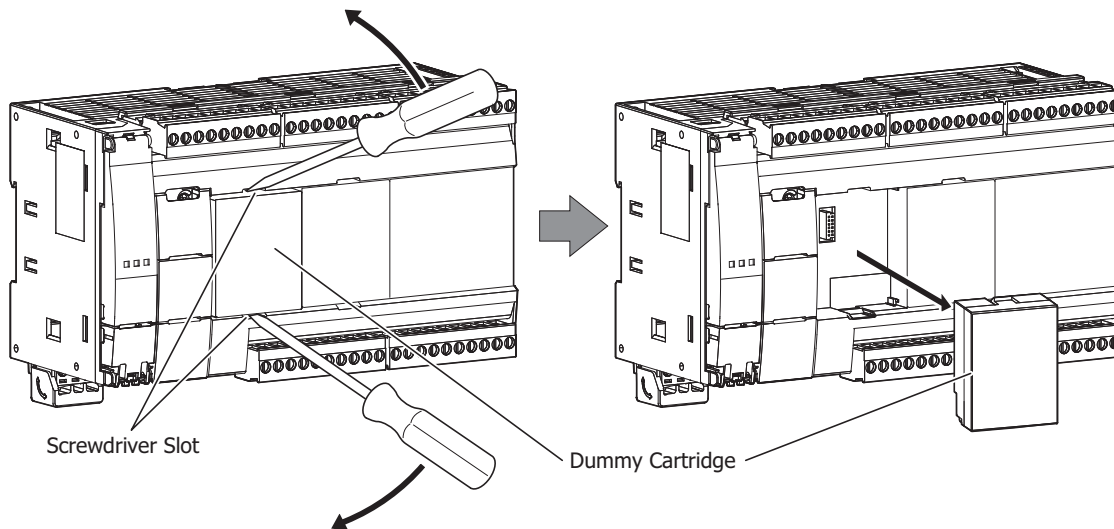

2. Take care with the vertical orientation of the analog I/O cartridge and firmly push the analog I/O cartridge connector onto cartridge slot 1 on the CPU module.

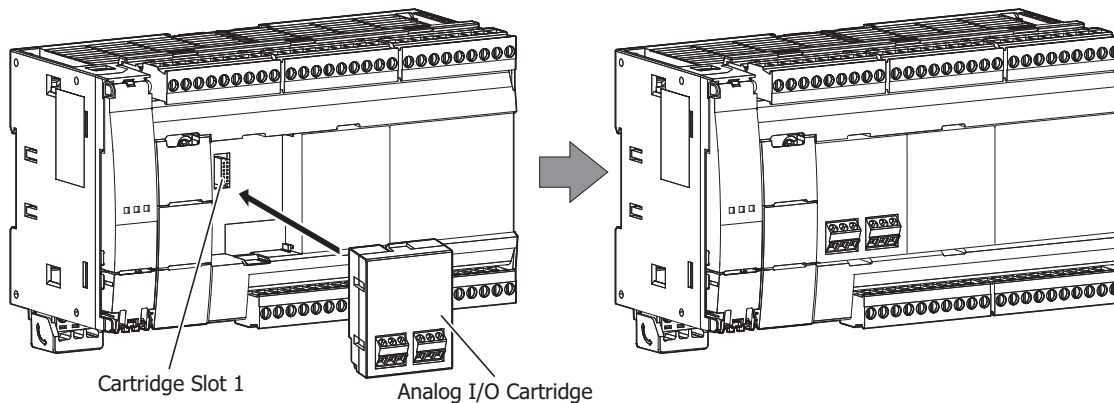

Caution

- Do not perform this work when the FC6A Series MICROSmart is powered. Otherwise there is a risk of damage.
- Attach and remove the cartridge straight in relation to the CPU module. If you attach or remove the cartridge at an angle, there is a risk of damage or communication failure.

Note: Cartridges cannot be attached to the Plus CPU module.

Assembling the HMI Module and a Cartridge

The following procedure describes the assembly of the HMI module (cartridge slot 3) and an analog I/O cartridge.

1. Unlock and open the front cover of the HMI module.
For details, see "Opening the Front Cover" on page 3-9.
2. Insert a flathead screwdriver into each of the screwdriver slots (two locations) on the HMI module and remove the dummy cartridge straight off the HMI module by pushing in the dummy cartridge tabs.

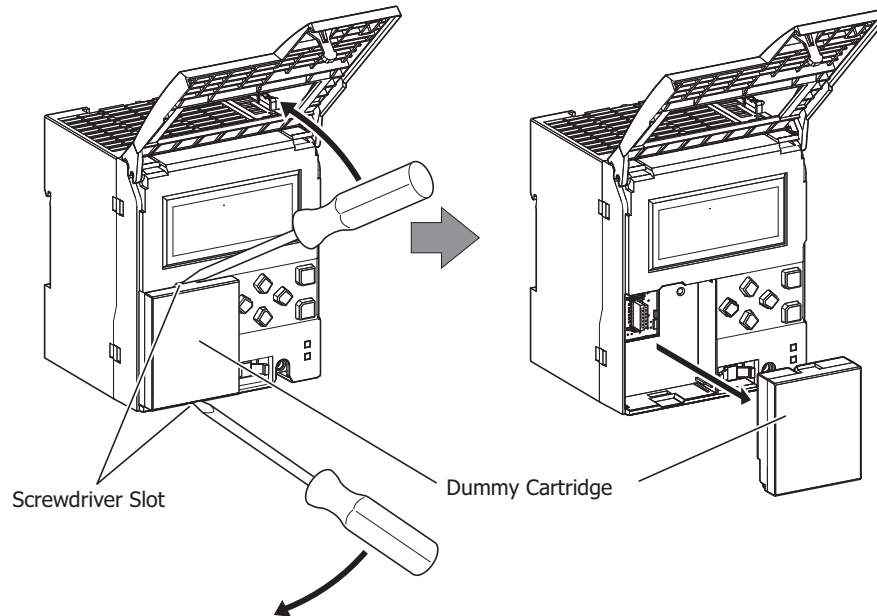

3. Take care with the vertical orientation of the cartridge and firmly push the cartridge connector onto cartridge slot 3 on the HMI module.

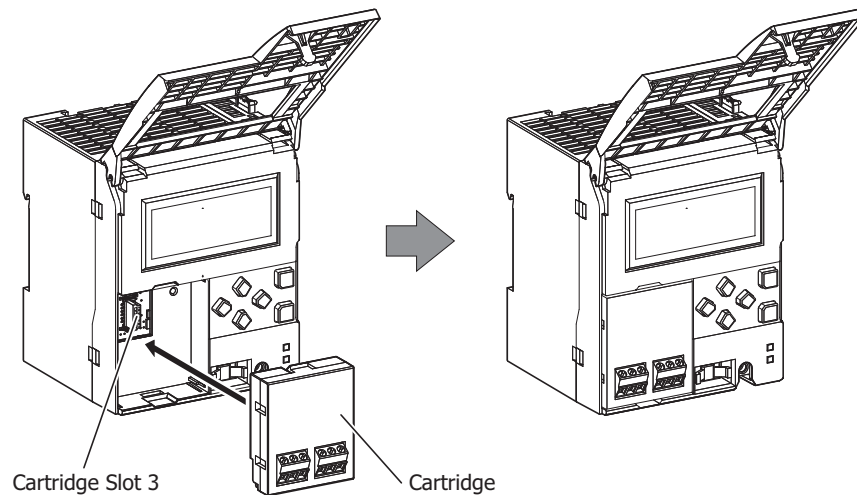

Caution

- Do not perform this work when the FC6A Series MICROSmart is powered. Otherwise there is a risk of damage.
- Attach and remove the cartridge straight in relation to the HMI module. If you attach or remove the cartridge at an angle, there is a risk of damage or communication failure.

Note: A communication cartridge cannot be attached to cartridge slot 3 of an HMI module added to the All-in-One CPU module.

4. Close and lock the front cover of the HMI module.
For details, see "Closing the Front Cover" on page 3-9.

Assembling the Cartridge Base Module and a Cartridge

The following procedure describes the assembly of the cartridge base module (cartridge slot 1) and an analog I/O cartridge.

1. Insert a flathead screwdriver into each of the screwdriver slots (two locations) on the cartridge base module (cartridge slot 1) and remove the dummy cartridge straight off the cartridge base module by pushing down the dummy cartridge tabs.

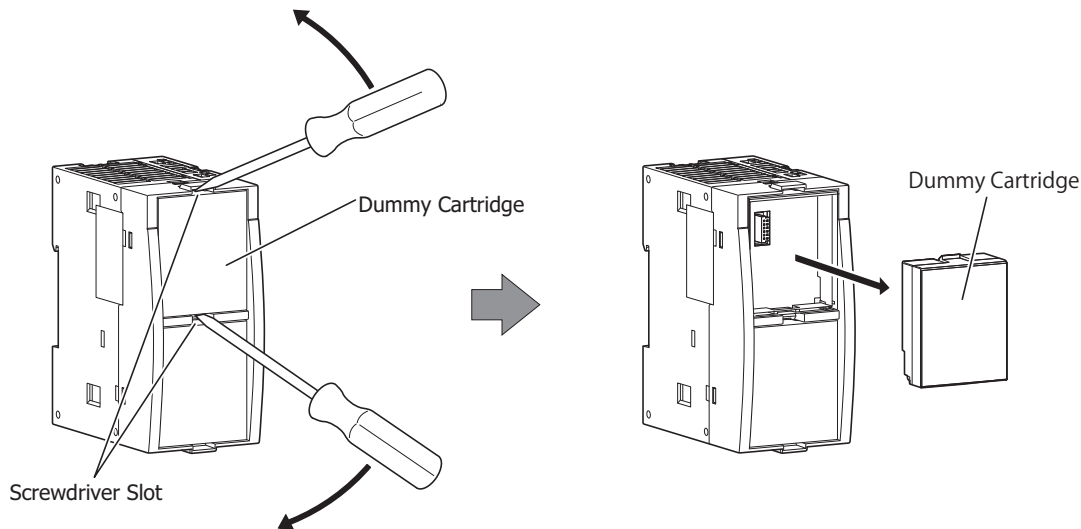

2. Take care with the vertical orientation of the analog I/O cartridge and firmly push the analog I/O cartridge connector onto cartridge slot 1 on the cartridge base module.

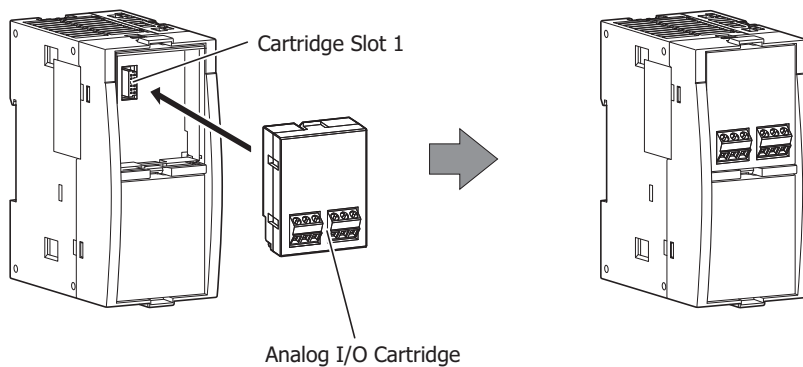

Caution

- Do not perform this work when the FC6A Series MICROSmart is powered. Otherwise there is a risk of damage.
- Attach and remove the cartridge straight in relation to the cartridge base module. If you attach or remove the cartridge at an angle, there is a risk of damage or communication failure.

Note: The cartridge base module cannot be attached to the All-in-One CPU module.

Opening and Closing the Front Cover of the HMI Module

The following procedure describes how to open and close the front cover of the HMI module.

Opening the Front Cover



Caution

Always unlock the front cover before opening it with the following procedure. Otherwise there is a risk of damage to the HMI module.

1. Push the access symbol until it clicks to unlock the front cover.
2. The front cover will open.

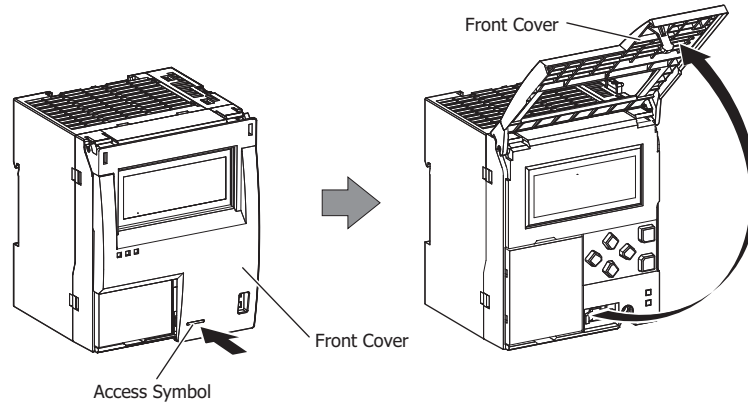

Closing the Front Cover



Caution

Always lock the front cover with the following procedure.

1. Close the front cover.
2. Push the access symbol until it clicks to lock the front cover.

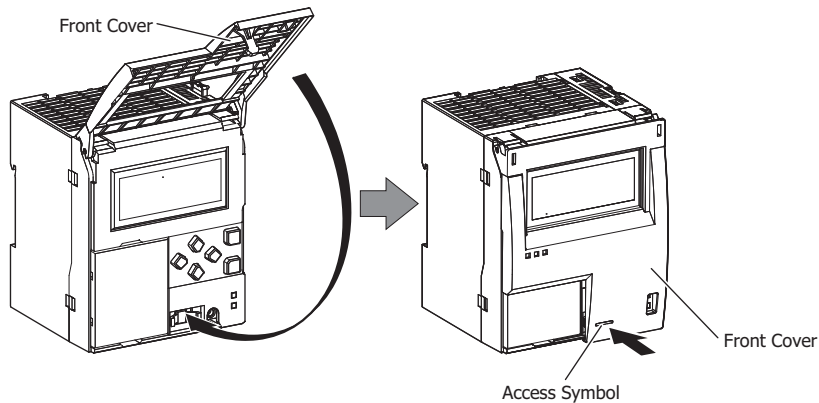

Caution

Applying too much force to the front cover may cause it to fall off. If this happens, make the front cover vertical with the HMI module as shown in the following figure, and then slowly push on the part indicated by the arrow.

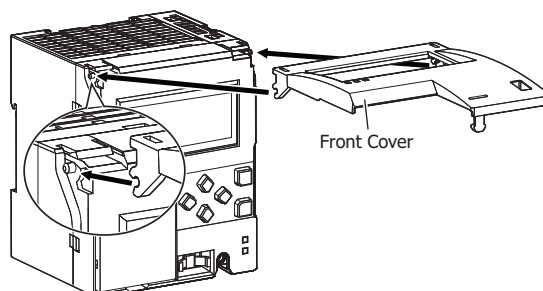

Mounting on DIN Rail



Caution

- Install the FC6A Series MICROSmart modules according to instructions described in this manual. Improper installation will result in falling, failure, or malfunction of the FC6A Series MICROSmart.
- Do not install the FC6A Series MICROSmart when it is powered up. Doing so may result in electric shock and may damage the product.

This section describes how to mount the FC6A Series MICROSmart.

The FC6A Series MICROSmart can be mounted on a DIN rail or directly to a panel inside a cabinet.

DIN Rail Mounting and Removal

The following procedure describes how to mount and remove the FC6A Series MICROSmart to and from a DIN rail.

1. Firmly fasten the DIN rail to a panel using screws.
2. Using a flat head screwdriver, lower the DIN rail hook (1) and hang the FC6A Series MICROSmart on the DIN rail (2).

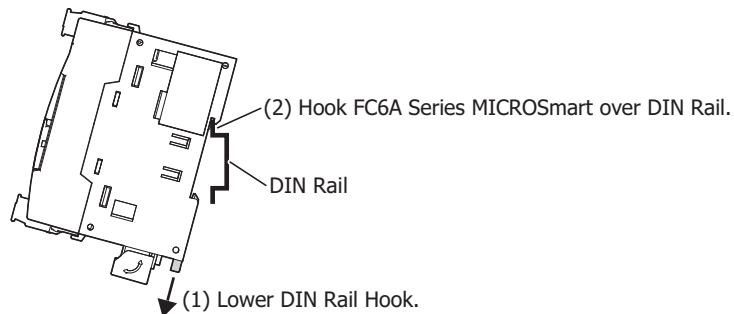

3. Align the FC6A Series MICROSmart with the DIN rail (1) and raise the DIN rail hook (2).

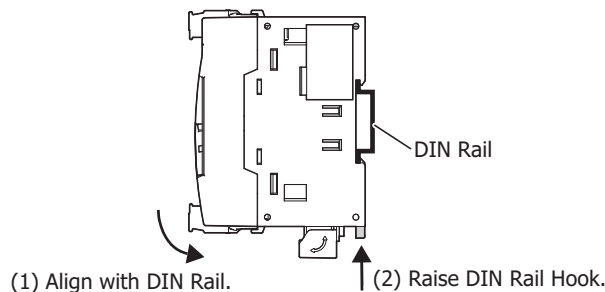

4. Secure both ends of the FC6A Series MICROSmart using the DIN rail brackets.

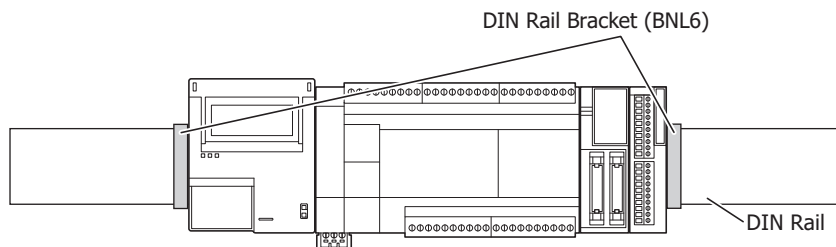

Notes:

- The FC6A Series MICROSmart supports 35 mm wide DIN rails.
Supported rails: IDEC BAA1000 (Length: 1,000 mm)
Rail bracket: BNL6PN10
- The FC6A Series MICROSmart can also be mounted by hooking it onto the DIN rail when the DIN rail hook is raised and pushing it on until it clicks.

Removing from DIN Rail

1. Lower the FC6A Series MICROSmart's DIN rail hook with a flathead screwdriver (1) and lift it up while pulling forward (2).

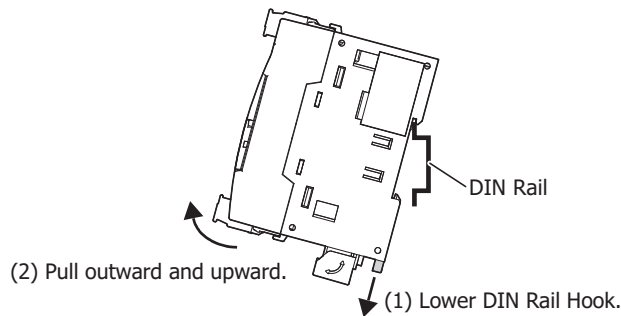

Direct Mounting on Panel Surface

This section describes how to mount the FC6A Series MICROSmart directly onto a mounting plate for installation in a control panel. The direct mounting method differs according to the FC6A Series MICROSmart. To mount the FC6A Series MICROSmart directly, it may be necessary to make holes in the mounting plate depending on the FC6A Series MICROSmart model.

Direct Mounting Methods

■ **16- and 24-I/O types**

Mount using the screw holes on the back of the module.

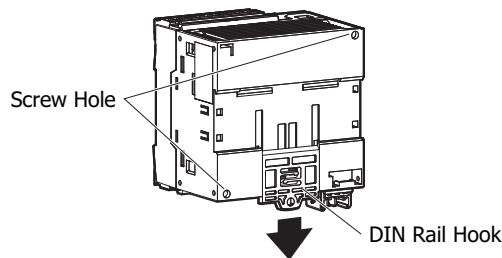

■ **40-I/O type and the HMI module**

Pull out the DIN rail hook on the back of the module, attach the direct mounting hook (maintenance part: FC6A-PSP1PN05), and then mount the module to the mounting plate using the screw holes.

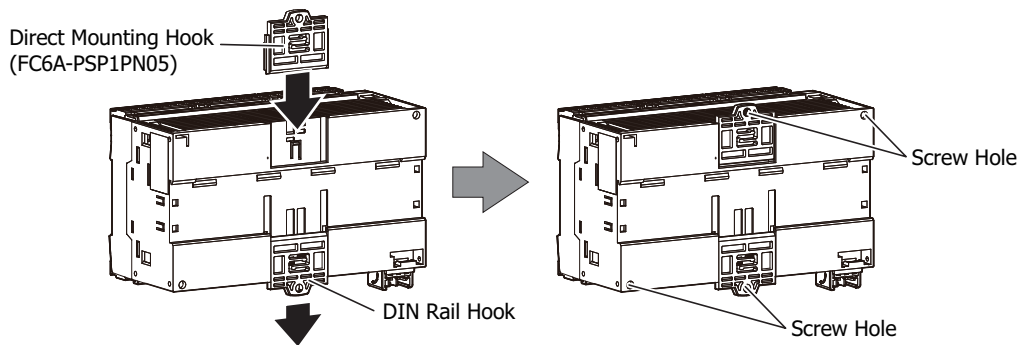

■ **Expansion and expansion interface modules**

Pull out the DIN rail hook on the back of the module, attach the direct mounting hook (maintenance part: FC6A-PSP2PN05), and then mount the module to the mounting plate using the screw holes.

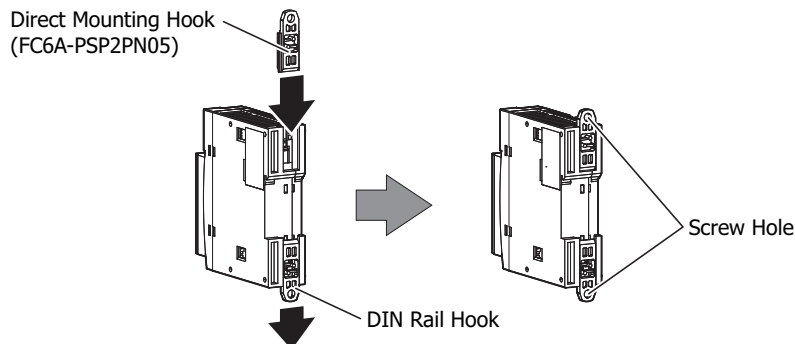

3: INSTALLATION AND WIRING

Mounting Hole Layout for Direct Mounting on Panel Surface

As shown in the following diagram, mount the FC6A Series MICROSmart to the mounting plate with M4 pan head screws. Always give sufficient consideration to operability, ease-of-maintenance, and environmental resistance when deciding on the mounting position.

 **Caution** When directly mounting the FC6A Series MICROSmart, tighten mounting screws with torque of 1 N·m (kgf·cm).

■ CPU Modules

- **16-I/O type:** Screw fastened type: FC6A-C16R1AE, FC6A-C16R1CE, FC6A-C16K1CE, FC6A-C16P1CE, FC6A-C16R1DE, FC6A-C16K1DE, FC6A-D16P1DE
Push-in type: FC6A-C16R4AE, FC6A-C16R4CE, FC6A-C16K4CE, FC6A-C16P4CE, FC6A-C16R4DE, FC6A-C16K4DE, FC6A-D16P4DE

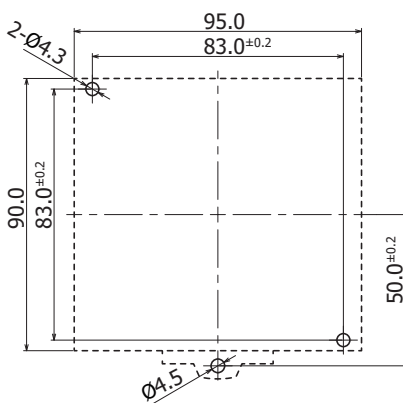

All dimensions in mm.

- **24-I/O type:** Screw fastened type: FC6A-C24R1AE, FC6A-C24R1CE, FC6A-C24K1CE, FC6A-C24P1CE
Push-in type: FC6A-C24R4AE, FC6A-C24R4CE, FC6A-C24K4CE, FC6A-C24P4CE

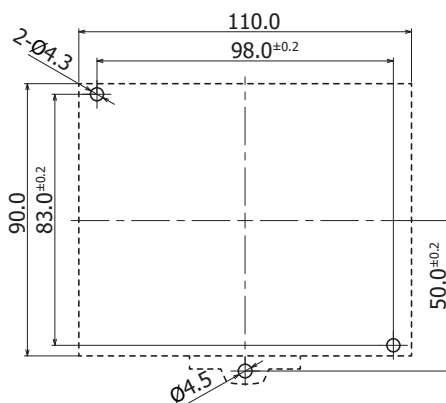

All dimensions in mm.

- 40-I/O type: Screw fastened type: FC6A-C40R1AE, FC6A-C40R1CE, FC6A-C40K1CE, FC6A-C40P1CE, FC6A-C40R1DE, FC6A-C40K1DE, FC6A-C40P1DE, FC6A-C40R1AEJ, FC6A-C40R1CEJ, FC6A-C40K1CEJ, FC6A-C40P1CEJ, FC6A-C40R1DEJ, FC6A-C40K1DEJ, FC6A-C40P1DEJ

Push-in type:

- FC6A-C40R4AE, FC6A-C40R4CE, FC6A-C40K4CE, FC6A-C40P4CE, FC6A-C40R4DE, FC6A-C40K4DE, FC6A-C40P4DE, FC6A-C40R4AEJ, FC6A-C40R4CEJ, FC6A-C40K4CEJ, FC6A-C40P4CEJ, FC6A-C40R4DEJ, FC6A-C40K4DEJ, FC6A-C40P4DEJ

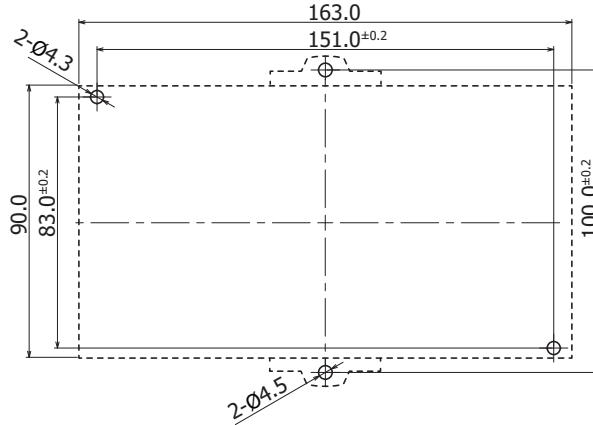

All dimensions in mm.

- Plus CPU module: FC6A-D16R1CEE, FC6A-D16R4CEE, FC6A-D16K1CEE, FC6A-D16K4CEE, FC6A-D16P1CEE, FC6A-D16P4CEE, FC6A-D32K3CEE, FC6A-D32K4CEE, FC6A-D32P3CEE, FC6A-D32P4CEE

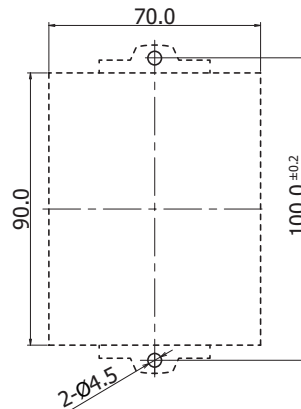

All dimensions in mm.

3: INSTALLATION AND WIRING

■ Expansion Modules, Expansion Interface Modules, HMI Module, and Cartridge Base Module

Digital input modules:	Screw fastened type:	FC6A-N08B1, FC6A-N16B1, FC6A-N08A11
	Push-in type:	FC6A-N08B4, FC6A-N16B4, FC6A-N08A14
Digital output modules:	Screw fastened type:	FC6A-R081, FC6A-R161, FC6A-T08K1, FC6A-T16K1, FC6A-T08P1, FC6A-T16P1
	Push-in type:	FC6A-R084, FC6A-R164, FC6A-T08K4, FC6A-T16K4, FC6A-T08P4, FC6A-T16P4
Digital mixed I/O modules:	Screw fastened type:	FC6A-M08BR1
	Push-in type:	FC6A-M08BR4
Analog I/O modules:	Screw fastened type:	FC6A-J2C1, FC6A-J4A1, FC6A-J8A1, FC6A-K2A1, FC6A-K4A1, FC6A-J4CN1, FC6A-J4CH1Y, FC6A-J8CU1, FC6A-K2A1, FC6A-K4A1, FC6A-L03CN1, FC6A-L06A1
	Push-in type:	FC6A-J2C4, FC6A-J4A4, FC6A-J8A4, FC6A-K2A4, FC6A-K4A4, FC6A-J4CN4, FC6A-J4CH4Y, FC6A-J8CU4, FC6A-K2A4, FC6A-K4A4, FC6A-L03CN4, FC6A-L06A4
Communication modules:	Screw fastened type:	FC6A-SIF52
	Push-in type:	FC6A-SIF524
Expansion interface remote master module:		FC6A-EXM1M

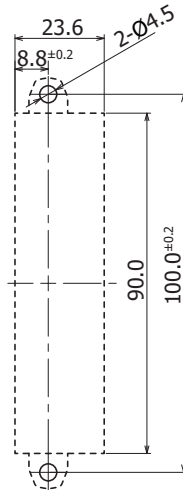

All dimensions in mm.

Digital input modules: FC6A-N16B3
Digital output modules: FC6A-T16K3, FC6A-T16P3

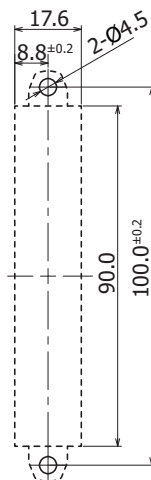

All dimensions in mm.

Digital input modules: FC6A-N32B3
Digital output modules: FC6A-T32K3, FC6A-T32P3

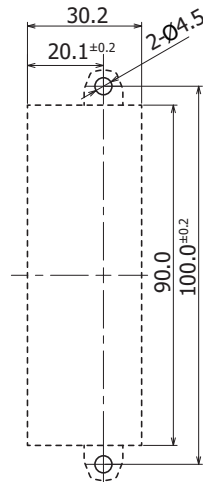

All dimensions in mm.

Digital mixed I/O modules:	Screw fastened type:	FC6A-M24BR1
	Push-in type:	FC6A-M24BR4
PID modules:	Screw fastened type:	FC6A-F2M1, FC6A-F2MR1
	Push-in type:	FC6A-F2M4, FC6A-F2MR4
Expansion interface module (expander):	Screw fastened type:	FC6A-EXM2
	Push-in type:	FC6A-EXM24

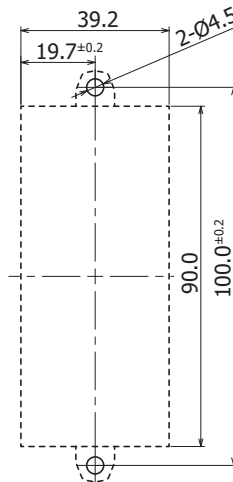

All dimensions in mm.

Expansion interface remote slave module: FC6A-EXM1S, FC6A-EXM1S4

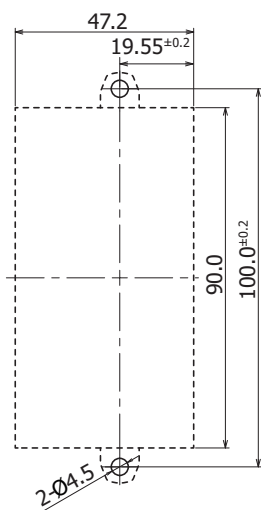

All dimensions in mm.

HMI module: FC6A-PH1

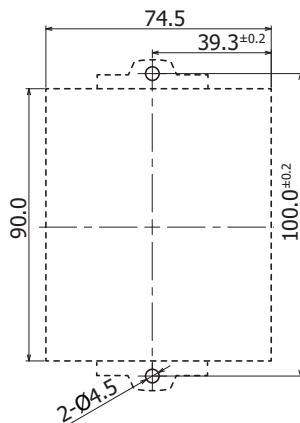

All dimensions in mm.

Cartridge base module: FC6A-HPH1

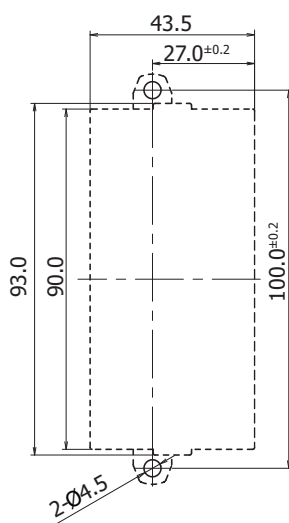

All dimensions in mm.

■ **Example:**
Mounting hole layout for FC6A-C40R1AE, FC6A-N32B3, FC6A-T16K3, FC6A-F2MR1, and C6A-L06A1

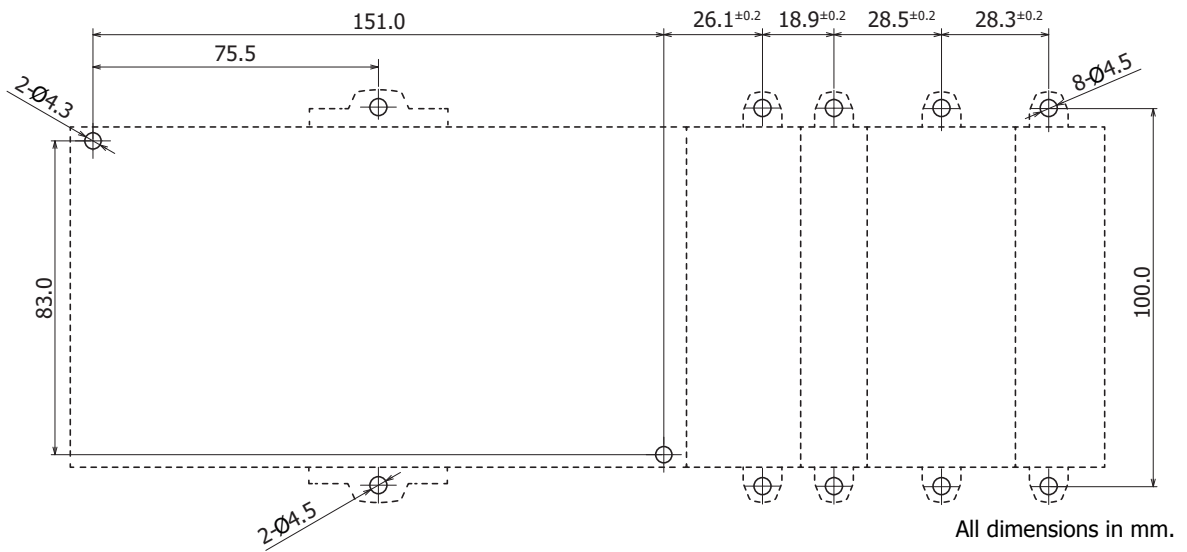

Input/Output Wiring

This section describes FC6A Series MICROSmart input/output device wiring.

Precautions for I/O Device Wiring

Input Terminal Wiring

When wiring input devices, separate wiring from power, output, and motor lines.

For the wires to use with the CPU modules, expansion modules, and cartridges, see "Recommended Ferrule List" on page 3-46.

DC Sink Input Wiring Example

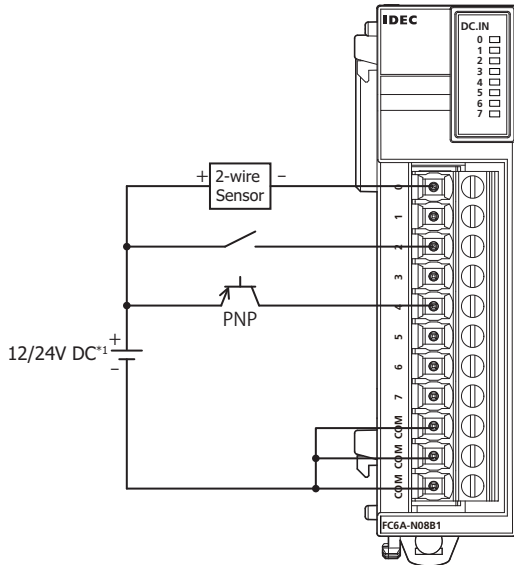

DC Source Input Wiring Example

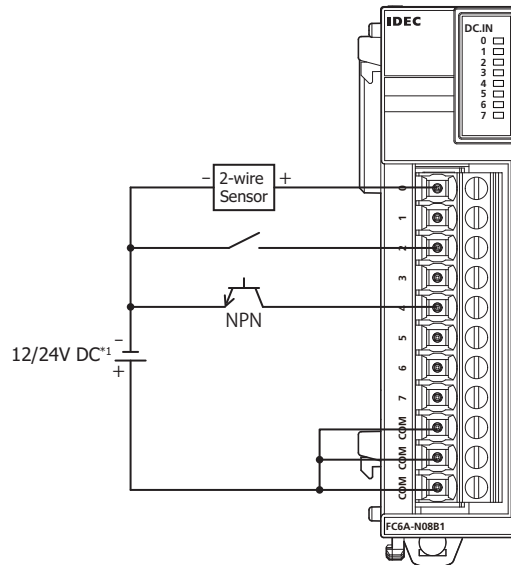

*1 24V DC for products with a version number lower than V400. For details on the version number of modules, see "Checking the Version Number" on page 2-1.

Output Terminal Wiring



Caution

- If output relays or transistors in the FC6A Series MICROSmart or output modules should fail, outputs may remain on or off. For output signals which may cause heavy accidents, provide a monitor circuit outside the FC6A Series MICROSmart.
- Connect a fuse to the output module, selecting a fuse appropriate for the load.
- When equipment containing the FC6A Series MICROSmart is intended for use in European countries, insert an IEC 60127-approved fuse to each output of every module for protection against overload or short-circuit. This is required when equipment containing the FC6A Series MICROSmart is destined for Europe.
- When driving an inductive load that emits noise like a magnet or a valve, to reduce noise and protect circuits, use a diode for the output on DC power type models and a surge absorber for the output on AC power type models.
- For the wires to use with the CPU modules, expansion modules, and cartridges, see "Recommended Ferrule List" on page 3-46.

Output Protection Circuit

When a motor, solenoid, or similar inductive load is connected, the life of the contact is shortened due to the inrush current and counter-electromotive force acting on the load. In order to prevent this, set up an output protection circuit outside the FC6A Series MICROSmart. Choose a protection circuit from (1) through (4) shown below, according to the power supply, and connect the protection circuit to the outside of the FC6A Series MICROSmart.

For protection of the transistor output of the FC6A Series MICROSmart modules, connect protection circuit (3) shown below to the transistor output circuit.

Protection Circuit (1)

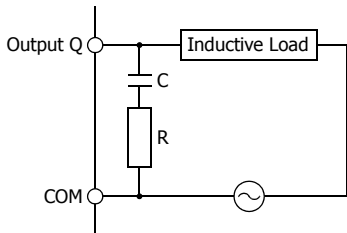

This protection circuit can be used when the load impedance is smaller than the RC impedance in an AC load power circuit.

R: Resistor of approximately the same resistance value as the load
C: 0.1 to 1 μ F

Protection Circuit (2)

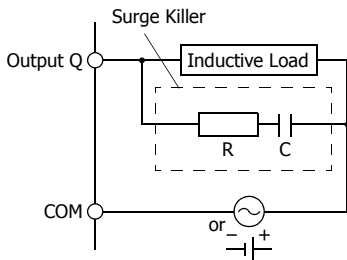

This protection circuit can be used for both AC and DC load power circuits.

R: Resistor of approximately the same resistance value as the load
C: 0.1 to 1 μ F

Protection Circuit (3)

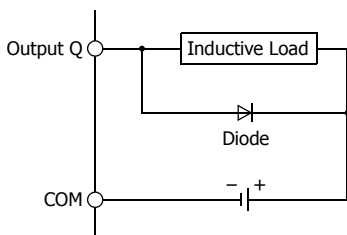

This protection circuit can be used for DC load power circuits.

Use a diode with the following ratings.

Reverse withstand voltage: Power voltage of the load circuit \times 10
Forward current: More than the load current

Protection Circuit (4)

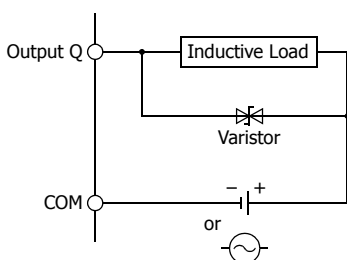

This protection circuit can be used for both AC and DC load power circuits.

Power Supply and Power Supply Wiring

Power Supply

This section describes how to connect a power supply to the FC6A Series MICROSmart.



Caution

- Use a power supply of the rated value. Use of the wrong power supply may cause fire or malfunction.
- Ensure that the power voltage to the FC6A Series MICROSmart does not exceed the allowable power voltage range described in the power supply specifications. The FC6A Series MICROSmart may run and stop repeatedly within this voltage range, particularly if the power voltage turns on or off very slowly.
- Use an IEC 60127-approved fuse on the power line outside the FC6A Series MICROSmart. This is required when equipment containing the FC6A Series MICROSmart is destined for Europe.

CPU Module

There are three power supply specifications for the All-in-One CPU module: the AC power type, the 24V DC power type, and the 12V DC power supply type.

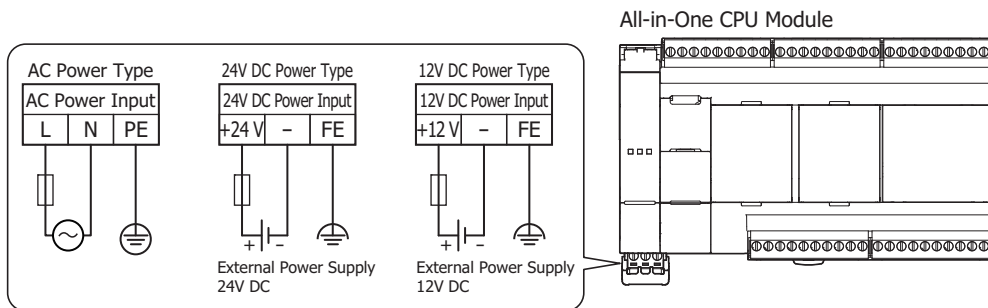

The power supply specification of the Plus CPU module is the 24V DC power type only.

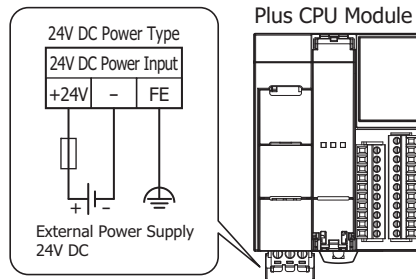

■ Power Supply Voltage

- The power supply voltages that can be used with the All-in-One CPU module are as follows.

AC power type: 85 to 264V AC

24V DC power type: 20.4 to 28.8V DC

12V DC power type: 10.2 to 18.0V DC

- The power supply voltage that can be used with the Plus CPU module is as follows.

24V DC power type: 20.4 to 28.8V DC



Warning

Do not use the FC6A Series MICROSmart outside of the power supply voltages listed above.

When an external device that carries the risk of causing a serious accident is connected to the inputs and outputs of the FC6A Series MICROSmart, implement measures in the external circuit (such as voltage monitoring) so that the device will function safely when there is a failure.

- The power failure detection voltage varies depending on the usage conditions of the inputs and outputs, but a power failure is normally detected when the power supply voltage is the following values.

AC power type: Less than 85V AC

24V DC power type: Less than 20.4V DC

12V DC power type: Less than 10.2V DC

- For all power supply types, a momentary power interruption of 10 ms or less is not recognized as a power failure when the power voltage is at the rated voltage.

Inrush Current at Powerup

The following inrush current flows through the FC6A Series MICROSmart when powered up. Use a power supply with sufficient capacity.

- AC power type: 40 A or lower
- 24V DC power type: 35 A or lower
- 12V DC power type: 35 A or lower

Expansion interface module

The power supply specification of the expansion interface module (expander) and expansion interface remote slave module is the 24V DC power type.

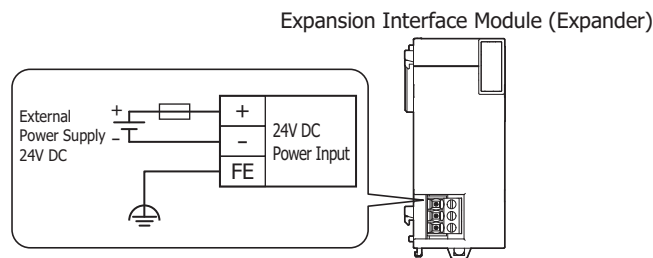

Power Supply Voltage

- The power supply voltage that can be used with the expansion interface module (expander) and expansion interface remote slave module is 20.4 to 28.8V DC.

	<p>Warning Do not use the FC6A Series MICROSmart outside of the power supply voltages listed above. When using the expansion interface module and an external device that carries the risk of causing a serious accident has been connected, implement measures in the external circuit (such as voltage monitoring) so that the device will function safely when there is a failure.</p>
--	--

- The power failure detection voltage varies depending on the usage conditions of the inputs and outputs, but a power failure is normally detected when the power supply voltage is less than 20.4V DC.
- A momentary power interruption of 10 ms or less is not recognized as a power failure when the power voltage is at the rated voltage.

Inrush Current at Powerup

An inrush current of 35 A or lower flows through the expansion interface module (expander) and expansion interface remote slave module when powered on. Use a power supply with sufficient capacity.

	<p>Caution When using the CPU module, expansion interface module (expander), and expansion interface remote slave module with separate power supplies, turn the power on and off in the following order. Power-up: Expansion interface module (expander) -> Expansion interface remote slave module (Downstream -> Upstream) -> CPU module Power-down: CPU module -> Expansion interface remote slave module (Upstream -> Downstream) -> Expansion interface module (expander) If the power supply is not shut off with the above sequence, the I/O for all expansion modules will not be updated.</p>
--	--

About the sequence to turn on and off the I/O power supply

When automatically running and stopping the FC6A Series MICROSmart in conjunction with turning the power supply to the FC6A Series MICROSmart on and off, use the following sequence to turn on and off the I/O power supply and CPU module main power. If the sequence is wrong, inputs and outputs may be mistakenly activated.

Power on: I/O power supply → CPU module main power
 Power off: CPU module main power → I/O power supply

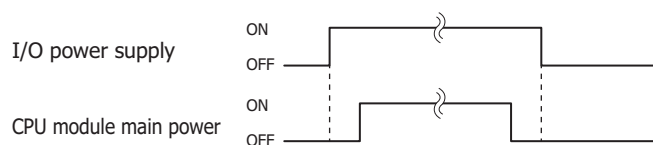

Power Supply Wiring

- Make the power line as short as possible. For details, see "Recommended Ferrule List" on page 3-46.
- Run the power line as far away as possible from motor lines.

Note:

Review the following items when there is a risk of malfunction due to electric shock and noise.

- Ground the PE and FE terminals with D-type ground (type 3: ground resistance of 100 Ω or lower).
- Do not use a shared ground wire for the FC6A Series MICROSmart and motor equipment.
- For ground wire details, see "Recommended Ferrule List" on page 3-46.

Power Supply Terminal Wiring Method

When wiring the power supply to the CPU module, the power supply terminals are removed from the CPU module, wired, and then once again attached to the CPU module.

The following procedure describes how to remove and attach the power supply terminals.

■ Removing the Power Supply Terminals

1. Slowly rotate the power supply terminals cover in the direction of the arrow.

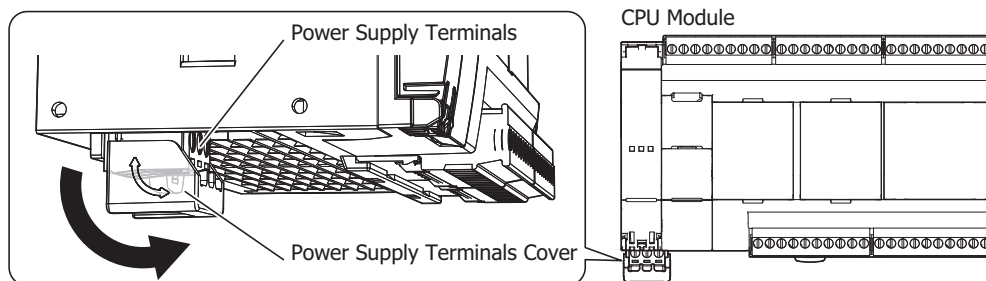

2. Rotate the power supply terminals cover until it touches the CPU module to unlock it, and then remove the power supply terminals.

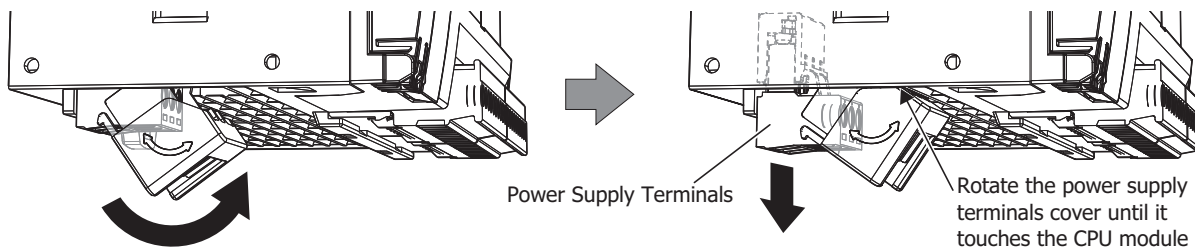

Notes:

- Rotate the power supply terminals cover in the direction of the arrow printed on the side.
- The power supply terminals move together with the power supply terminals cover when it is rotated.
- The following push-in types of CPU modules do not have the power supply terminals cover.
 - All-in-One CPU module:
FC6A-C16R4AE, FC6A-C16R4CE, FC6A-C16K4CE, FC6A-C16P4CE, FC6A-C16R4DE, FC6A-C16K4DE, FC6A-C16P4DE, FC6A-C24R4AE, FC6A-C24R4CE, FC6A-C24K4CE, FC6A-C24P4CE, FC6A-C40R4AE, FC6A-C40R4CE, FC6A-C40K4CE, FC6A-C40P4CE, FC6A-C40R4DE, FC6A-C40K4DE, FC6A-C40P4DE
 - CAN J1939 All-in-One CPU module:
FC6A-C40R4AEJ, FC6A-C40R4CEJ, FC6A-C40K4CEJ, FC6A-C40P4CEJ, FC6A-C40R4DEJ, FC6A-C40K4DEJ, FC6A-C40P4DEJ
 - Plus CPU module:
FC6A-D16R4CEE, FC6A-D16K4CEE, FC6A-D16P4CEE, FC6A-D32K4CEE, FC6A-D32P4CEE

■ Attaching the Power Supply Terminals

1. With the power supply terminals cover touching the CPU module, slowly push the power supply terminals with the attached power line straight into their original position.

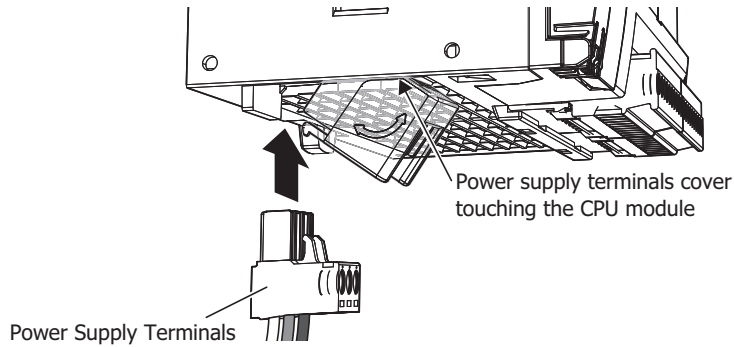

Caution

Push the power supply terminals straight in relation to the CPU module. If you push them in at an angle, there is a risk of damage or poor contact.

2. When the power supply terminals cover is rotated 45° or more from the CPU module, slowly rotate it in the direction of the arrow until it stops.
The power supply terminals cover and the power supply terminal block are locked.

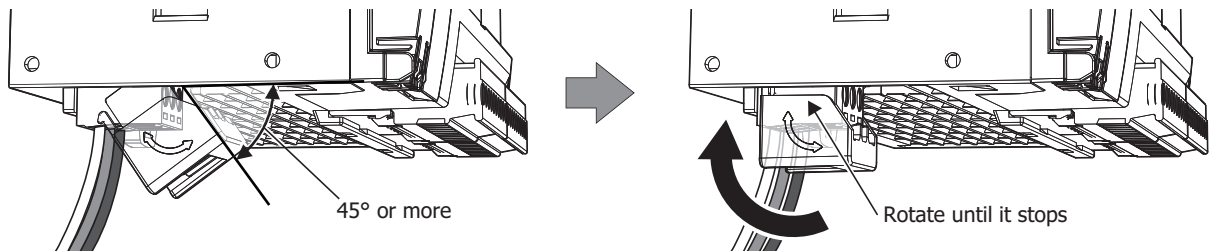

Notes:

- Rotate the power supply terminals cover in the direction of the arrow printed on the side.
- The power supply terminals move together with the power supply terminals cover when it is rotated.
- The following push-in types of CPU modules do not have the power supply terminals cover.
 - All-in-One CPU module:
FC6A-C16R4AE, FC6A-C16R4CE, FC6A-C16K4CE, FC6A-C16P4CE, FC6A-C16R4DE, FC6A-C16K4DE, FC6A-C16P4DE, FC6A-C24R4AE, FC6A-C24R4CE, FC6A-C24K4CE, FC6A-C24P4CE, FC6A-C40R4AE, FC6A-C40R4CE, FC6A-C40K4CE, FC6A-C40P4CE, FC6A-C40R4DE, FC6A-C40K4DE, FC6A-C40P4DE
 - CAN J1939 All-in-One CPU module:
FC6A-C40R4AEJ, FC6A-C40R4CEJ, FC6A-C40K4CEJ, FC6A-C40P4CEJ, FC6A-C40R4DEJ, FC6A-C40K4DEJ, FC6A-C40P4DEJ
 - Plus CPU module:
FC6A-D16R4CEE, FC6A-D16K4CEE, FC6A-D16P4CEE, FC6A-D32K4CEE, FC6A-D32P4CEE



Caution

Push the power supply terminals straight in relation to the CPU module. If you push them in at an angle, there is a risk of damage or poor contact.

Using the Ports

This section describes how to use the analog input and analog potentiometer, serial port 1, Ethernet port 1, and the USB port.

Removing and Attaching the Analog Port Cover

The following procedure describes how to remove and attach the analog port cover.

Removing the Analog Port Cover

1. Insert a flathead screwdriver into the screwdriver slot on the analog port cover and slowly move the screwdriver in the direction of the arrow to unlock the bottom lock.

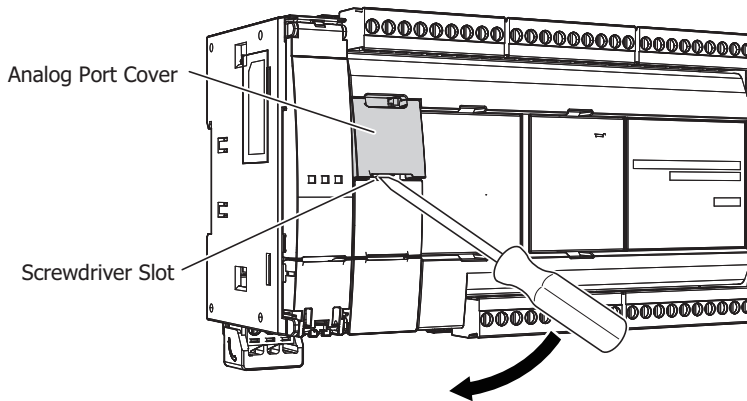

2. Lift up the analog port cover in the direction of the arrow to remove it.

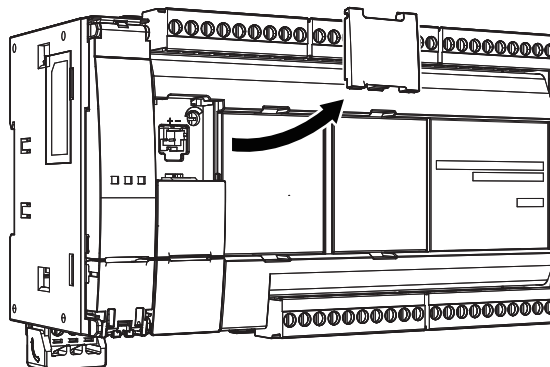

Attaching the Analog Port Cover

Attach the analog port cover after wiring the port.

1. Insert the tabs at the top of the analog port cover into the analog port cover slots, then push the bottom of the analog port cover in the direction of the arrow to attach it.

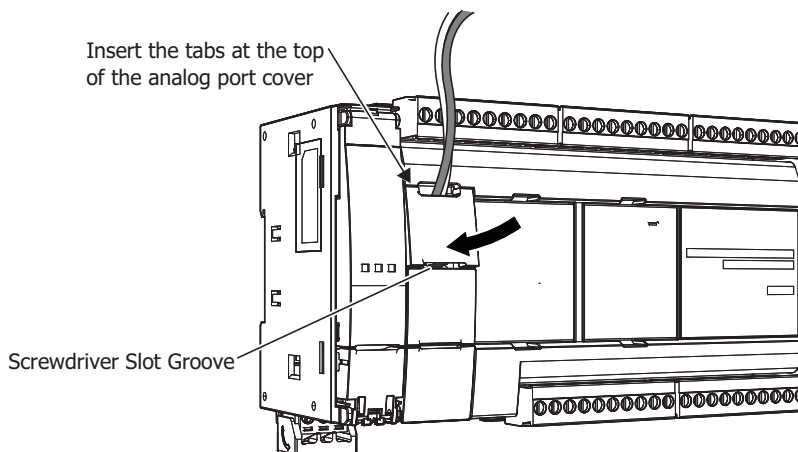

Note: Take care with the orientation of the analog port cover. The groove to insert the screwdriver goes on the bottom.

Removing and Attaching the Serial Port 1 Cover

The following procedure describes how to remove and attach the serial port 1 cover.

Removing the Serial Port 1 Cover

1. Insert a flathead screwdriver into the screwdriver slot on the serial port 1 cover and slowly move the screwdriver in the direction of the arrow to unlock the bottom lock.

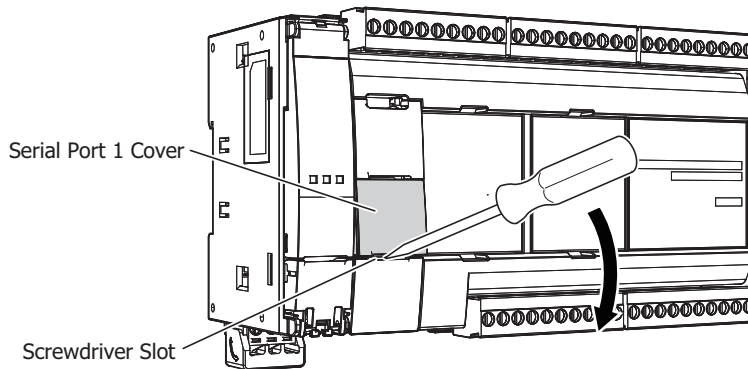

2. Lift the serial port 1 cover straight up in the direction of the arrow to remove it.

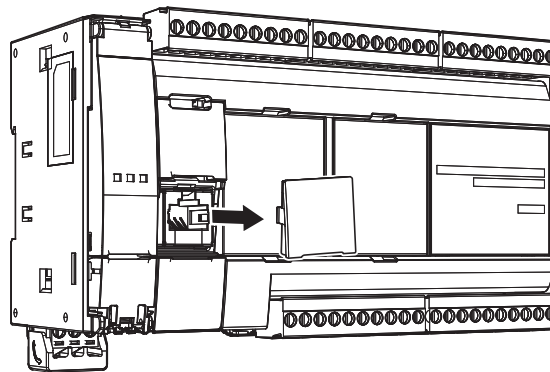

Attaching the Serial Port 1 Cover

When not using serial port 1, attach the serial port 1 cover.

1. Insert the serial port 1 cover tabs into the grooves on the left and right sides of serial port 1 and push the cover straight in to attach it.

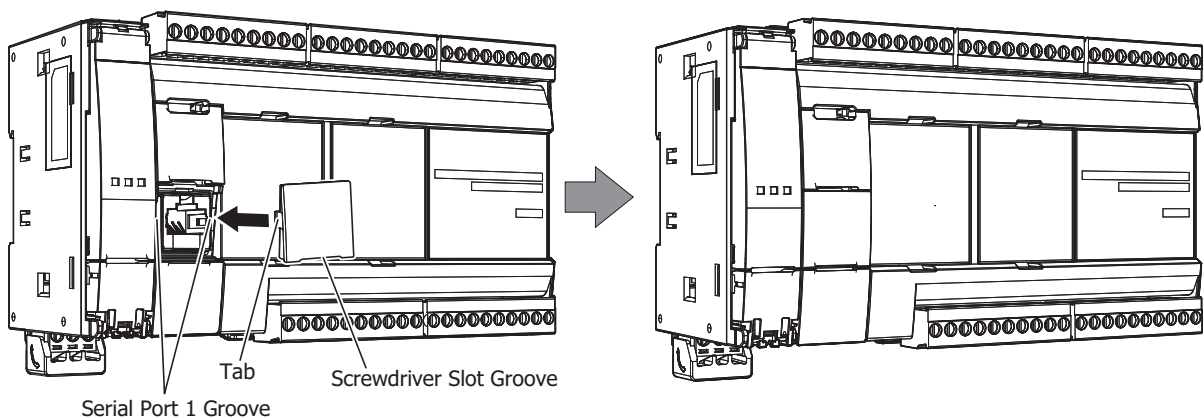

Note: Take care with the orientation of the serial port 1 cover. The groove to insert the screwdriver goes on the bottom.

Removing and Attaching the Ethernet Port 1 Cover

The following procedure describes how to remove and attach the Ethernet port 1 cover. The procedure is the same for Ethernet port 1 cover and Ethernet port 2 cover on the Plus CPU module.

Removing the Ethernet Port 1 Cover

1. Insert a flathead screwdriver into the screwdriver slot on the Ethernet port 1 cover and slowly move the screwdriver in the direction of the arrow to unlock the top lock.

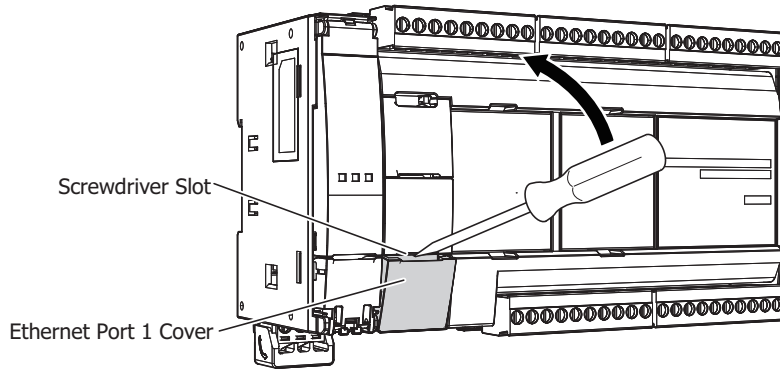

2. Lift the Ethernet port 1 cover straight up in the direction of the arrow to remove it.

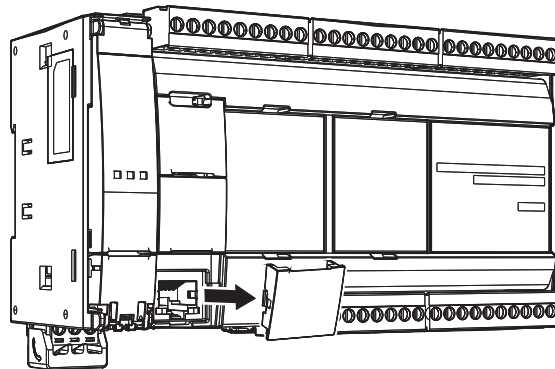

Attaching the Ethernet Port 1 Cover

When not using Ethernet port 1, attach the Ethernet port 1 cover.

1. Insert the Ethernet port 1 cover tabs into the grooves on the left and right sides of Ethernet port 1 and push the cover straight in to attach it.

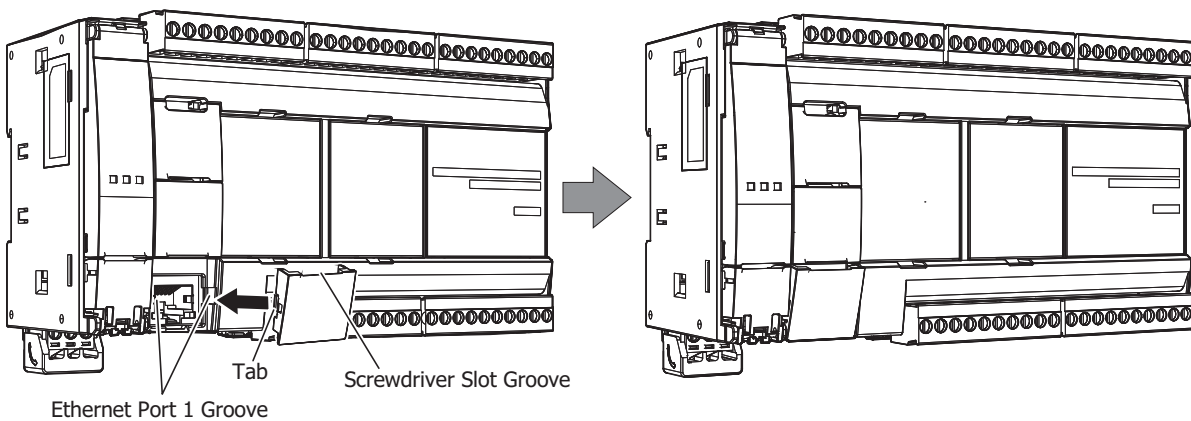

Note: Take care with the orientation of the Ethernet port 1 cover. The groove to insert the screwdriver goes on the bottom.

Opening and Closing the USB Port Cover

The following procedure describes how to open and close the USB port cover.

Opening the USB Port Cover

1. Insert a flathead screwdriver into the screwdriver slot on the USB port cover and slowly move the screwdriver in the direction of the arrow to unlock the top lock.

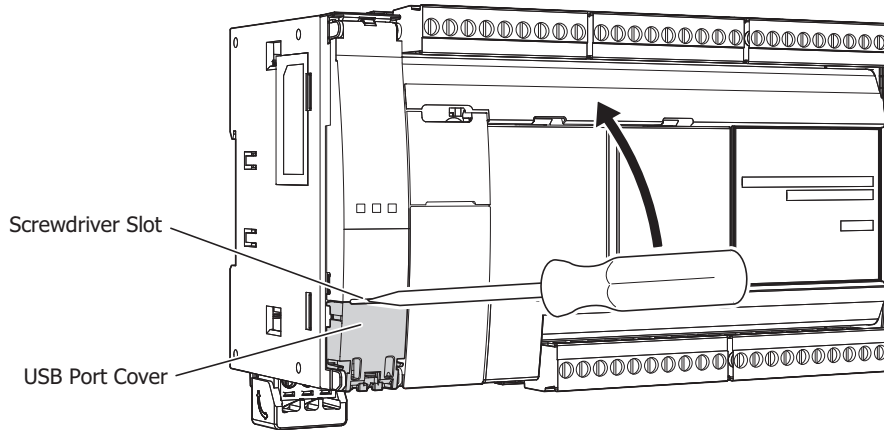

2. Open the USB port cover in the direction of the arrow.

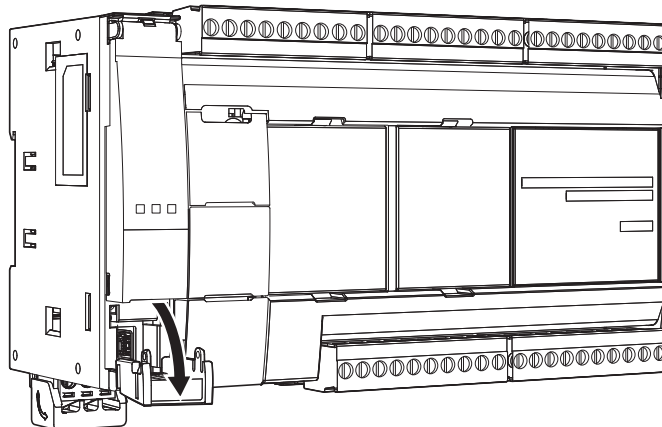

Note: To remove the USB cover, first open the cover in step 2, and then apply force in that same direction to remove the cover.

To communicate with a computer, use the USB cable (model: HG9Z-XCM42).

If you use the USB extension cable (model: HG9Z-XCE21), you can perform maintenance on an FC6A Series MICROSmart installed in a control panel from the face of the control panel. We recommend securing the USB extension cable to the USB port cover with a cable tie (HellermannTyton cable tie: T18R) so that the USB extension cable is not disconnected from the FC6A Series MICROSmart.

3: INSTALLATION AND WIRING

All-in-One CPU module/CAN J1939 All-in-One CPU module

- (1) Open the USB port cover and plug the USB cable into the USB port.
- (2) Lock the USB port cover and USB cable with a cable tie.

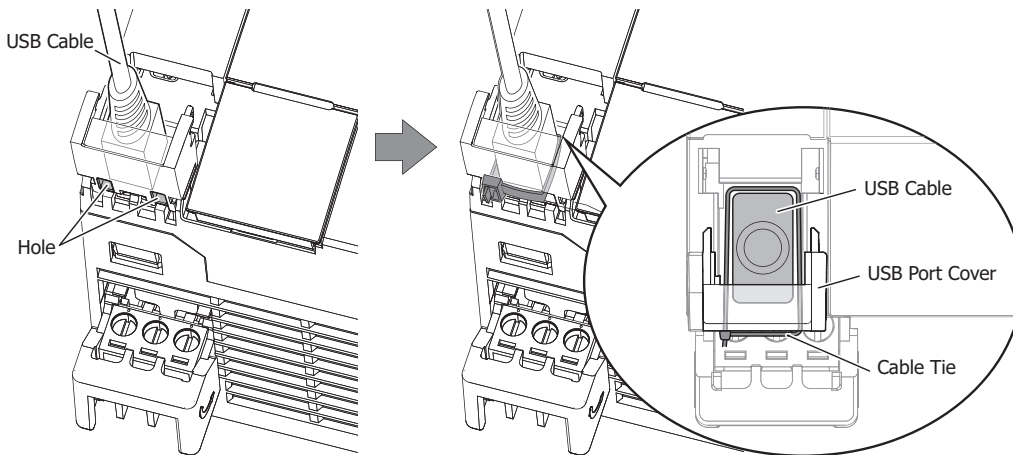

Plus CPU module

- (1) Open the SD memory card cover and remove the USB port cover.
Carefully store the removed USB port cover in a safe location.
- (2) Insert the USB cable retention pin into the top hole, and then insert it into the bottom hole.
- (3) Plug the USB cable into the USB port, and then lock the USB cable to the USB cable retention pin with a cable tie.

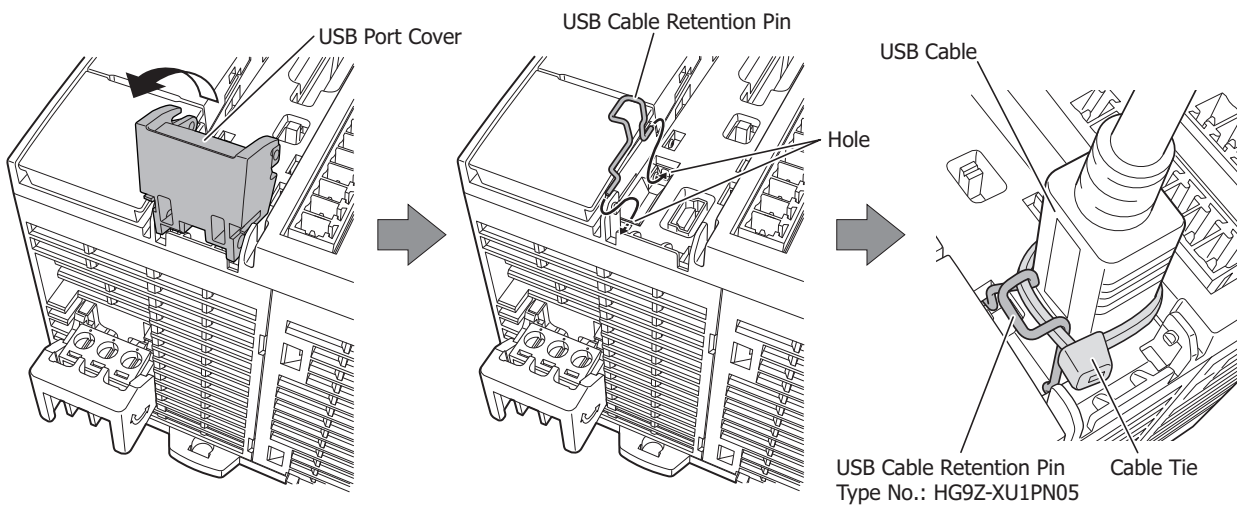



Caution

Applying too much force to the USB port cover may cause it to fall off. If this happens, make the USB port cover parallel with the CPU module as shown in the following figure, and then slowly push on the part indicated by the arrow.

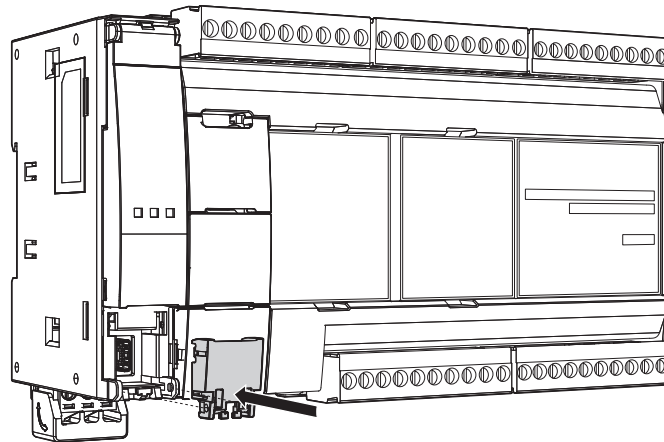

Closing the USB Port Cover

1. Close the USB port cover and push it until it clicks.

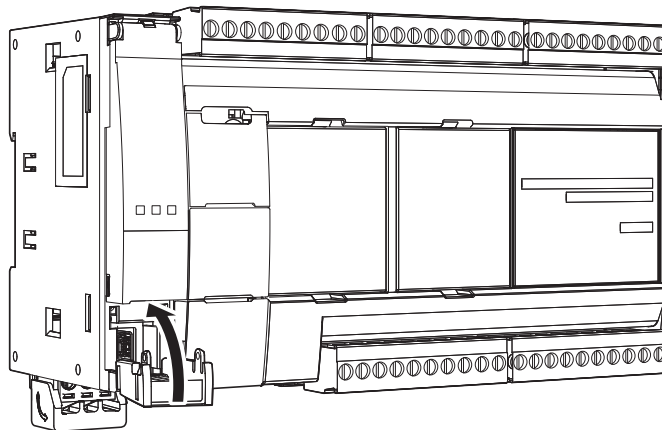

Using an SD Memory Card

This section describes how to use an SD memory card.

Opening and Closing the SD Memory Card Cover

The following procedure describes how to open and close the SD memory card cover.

Opening the SD Memory Card Cover

1. Insert a flathead screwdriver into the screwdriver slot on the SD memory card cover and slowly move the screwdriver in the direction of the arrow to unlock the bottom lock.

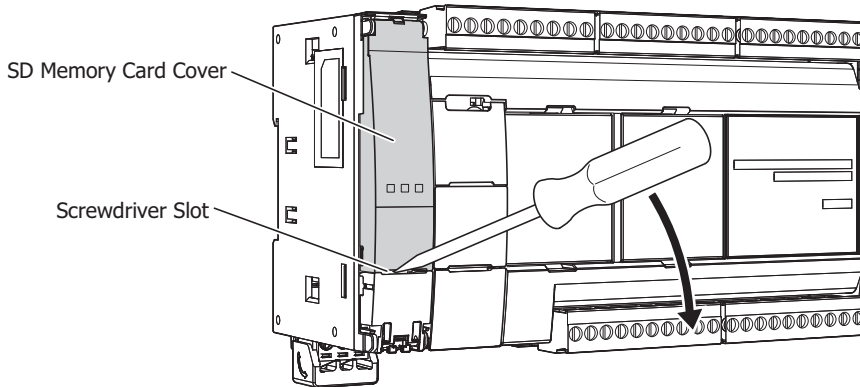

2. Open the SD memory card cover in the direction of the arrow.

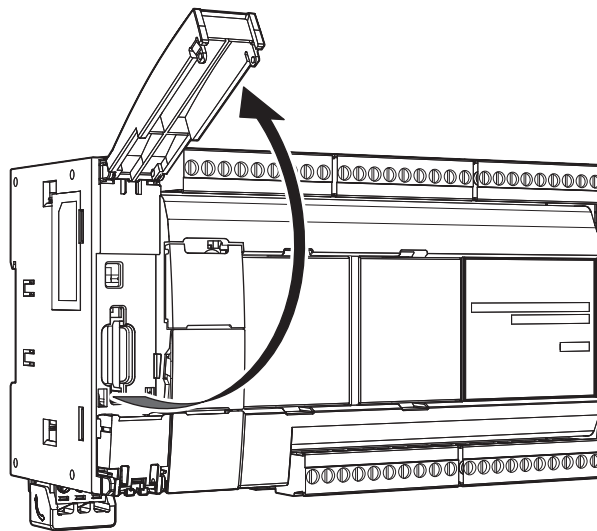

Caution

Applying too much force to the SD memory card cover may cause it to fall off. If this happens, make the SD memory card cover parallel with the CPU module as shown in the following figure, and then slowly push on the part indicated by the arrow.

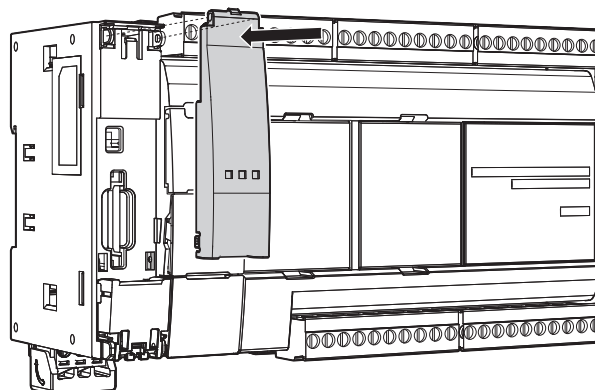

Closing the SD Memory Card Cover

1. Close the SD memory card cover and push it until it clicks.

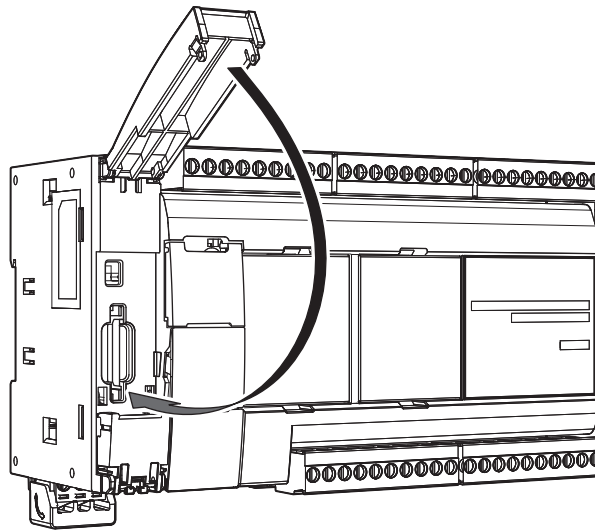

Inserting and Removing the SD Memory Card

The following procedure describes how to insert and remove the SD memory card.

Inserting the SD Memory Card

1. Unlock and open the SD memory card cover.
For details, see "Opening the SD Memory Card Cover" on page 3-30.
2. With the missing corner of the SD memory card facing the function switch side, push the SD memory card straight in until it clicks.

All-in-One CPU module
CAN J1939 All-in-One CPU module

Plus CPU module

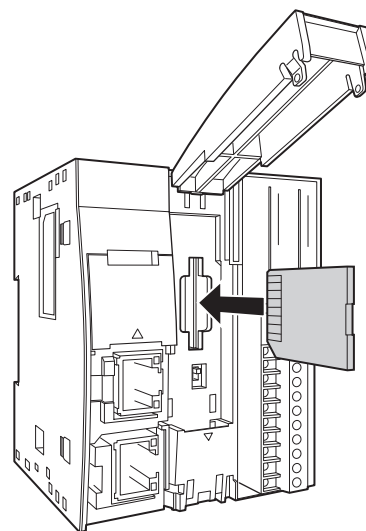
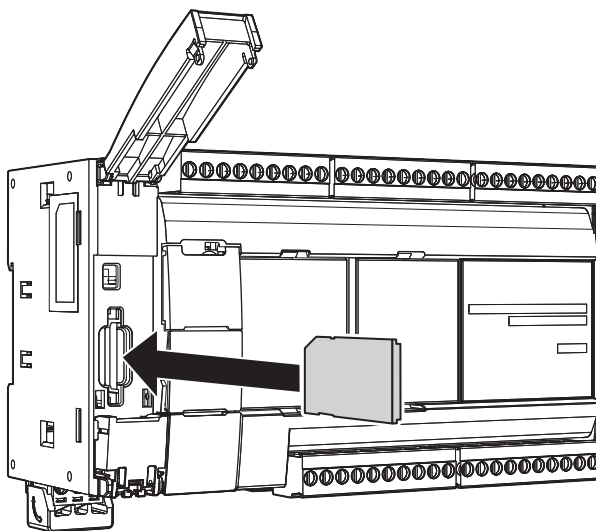

Notes:

- Use caution as the direction to insert the SD memory card depends on the model.
- Turn off the write protect switch on the SD memory card that will be inserted into the FC6A Series MICROSmart.

3. Close the SD memory card cover and push it until it clicks.
For details, see "Closing the SD Memory Card Cover" on page 3-31.

Removing the SD Memory Card

1. Unlock and open the SD memory card cover.
For details, see "Opening the SD Memory Card Cover" on page 3-30.
2. Push the SD memory card inserted into the FC6A Series MICROSmart until it clicks to unlock it.

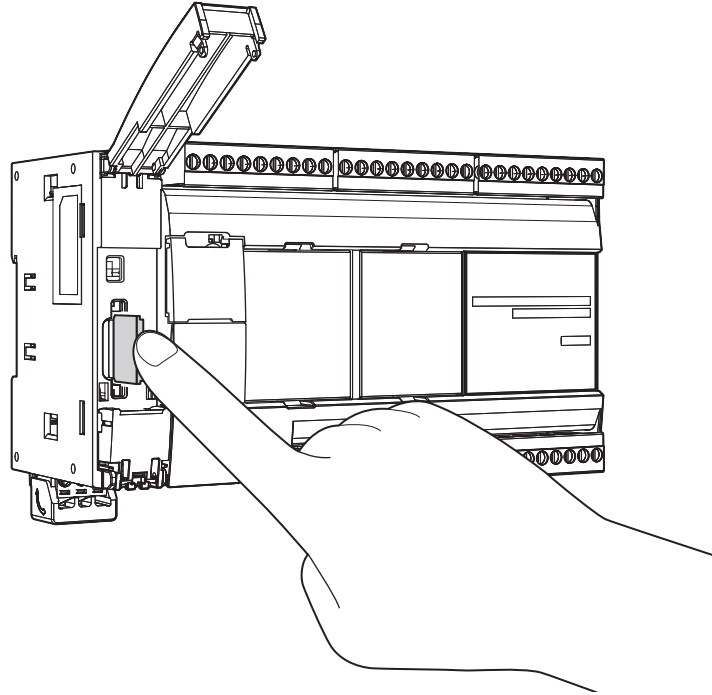

3. Slowly pull out the SD memory card.

All-in-One CPU module
CAN J1939 All-in-One CPU module

Plus CPU module

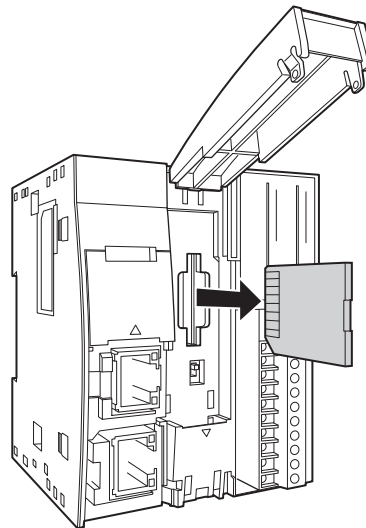
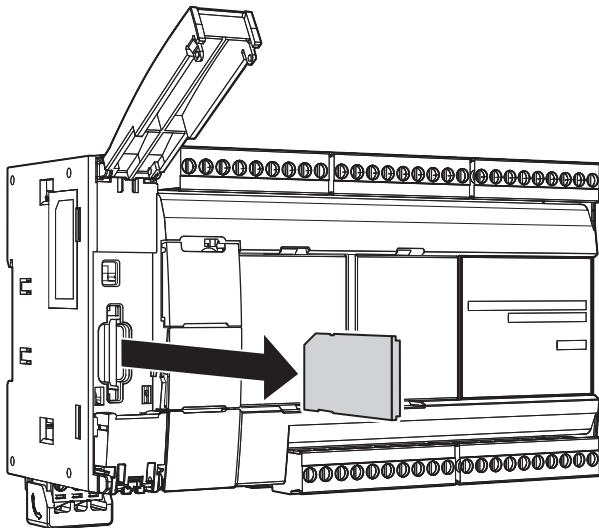

4. Close the SD memory card cover and push it until it clicks.
For details, see "Closing the SD Memory Card Cover" on page 3-31.

**Caution**

The data on the SD memory card may be corrupted by doing the following during access to the SD memory card.

- Turning the FC6A Series MICROSmart power OFF.
- Removing the SD memory card.

Do not turn OFF the FC6A Series MICROSmart power during access to the SD memory card (while the SD card status LED "SD" is flashing). First confirm that the SD card status LED "SD" is not flashing, then remove the SD memory card from FC6A Series MICROSmart. For details on the SD card status LED "SD", see "SD Memory Card" on page 11-1.

Replacing the Backup Battery

This section explains how to replace the backup battery.

Warning

Performing the work to attach and replace the backup battery in the unpowered state is recommended to avoid electric shock by touching the product and wired parts with the body or tools and to avoid damage to the product and malfunction. The backup battery can also be attached and replaced while powered and while power is supplied from the USB bus. However, first discharge any static electricity built up in the body by touching grounded metal before performing the work. Use caution so that electric shock from touching the product and wired parts with the body or tools, damage to the product, and malfunction do not occur.

Replacing the Backup Battery While Unpowered (Recommended)

To replace the backup battery, first turn off the power, and then perform the following steps 1 to 4 within 1 minute.

(The position of the battery holder is located on the right side of the top of the All-in-One CPU module and CAN J1939 All-in-One CPU module, and it is located on the left side of the top of the Plus CPU module.)

1. Grip both ends of the battery holder, and then pull it out.
The battery holder pulls out to a length of 36 mm.

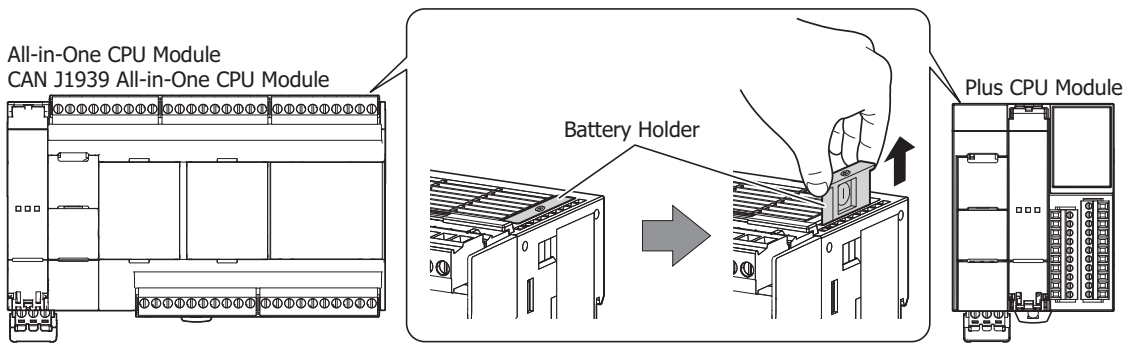

2. Remove the dead backup battery from the battery holder.
Orient the battery holder with the ⊕ side facing up. While pulling on the outside hook (1), press the backup battery from below (2).

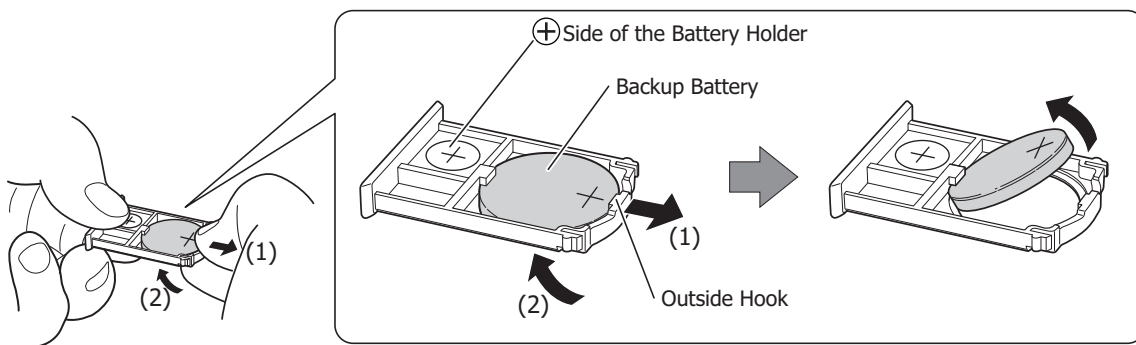

3. Insert a new backup battery into the battery holder.

Orient the battery holder with the ⊕ side facing up. Orient the new backup battery with the ⊕ side facing up. Press the backup battery into the inside hook of the battery holder (1), and then press down on the battery until you hear a click from the outside hook (2).

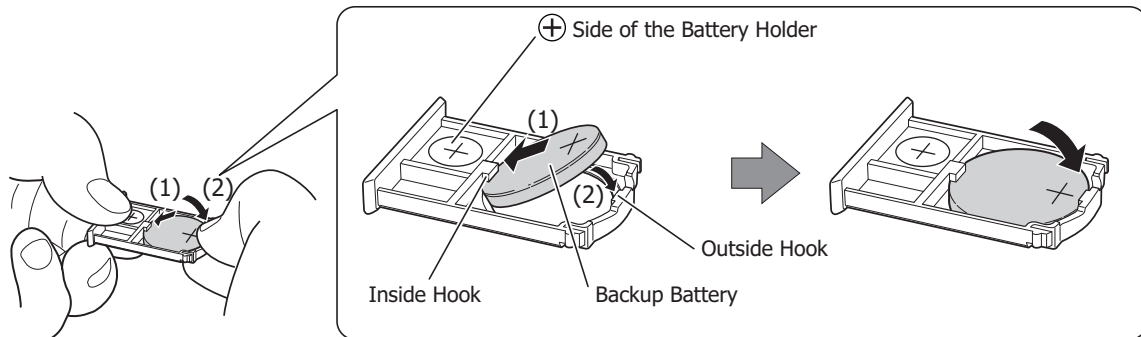

Note: Exercise caution regarding the orientation of the backup battery when you insert it.

4. Insert the battery holder into its original position, and then press it firmly as far as it will go.

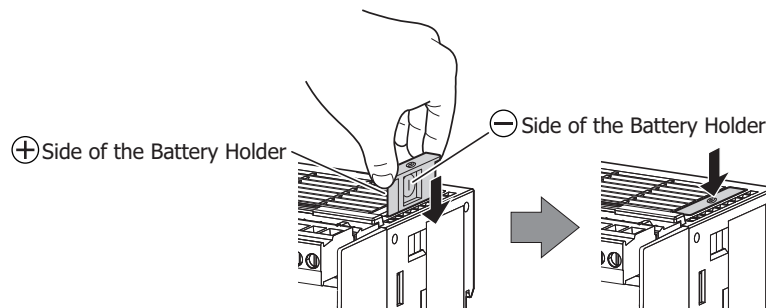

Note: Exercise caution regarding the orientation of the battery holder when you insert it.

5. After installing the battery, promptly turn on the power and confirm that the battery status LED [BAT] turns off (within one hour as a general rule).

 <p>Caution</p>	<ul style="list-style-type: none"> • To replace the backup battery while unpowered, complete the work within 1 minute after the power is turned off. If it takes a long time to replace the battery, the device values will be reset to the initial values. • After the battery is installed, relatively large amount of current may flow in the battery until the CPU module is powered. For this reason, immediately turn on the power or the USB bus power after installing the battery (within about an hour).
---	--

Replacing the Backup Battery While Power Is Supplied from the USB Bus

The backup battery can be replaced by supplying power from the USB bus. Use the following procedure to replace the backup battery by supplying power from the USB bus.

1. Turn on the power to supply to the product.
2. Connect a USB cable. (Start supplying USB bus power.)

Note: To supply power from the USB bus, use a computer or a power bank compatible with USB 2.0.

3. Turn off the power supplied to the product.
4. Replace the backup battery by following steps 1 to 4 in the replacement procedure in "Replacing the Backup Battery While Unpowered (Recommended)" on page 3-34. There is no time limit.
5. Disconnect the USB cable.
6. Turn on the power to supply to the product, and confirm that the battery status LED [BAT] turns off.

Replacing the Backup Battery While Powered

The backup battery can be replaced while the product is powered without turning off the power. Perform steps 1 to 4 in "Replacing the Backup Battery While Unpowered (Recommended)" on page 3-34 while the product is powered. There is no time limit on the replacement work.

Warning

- When the backup battery is attached and replaced while powered or while power is supplied from the USB bus, first discharge any static electricity built up in the body by touching grounded metal before performing the work. Use caution so that electric shock from touching the product and wired parts with the body or tools, damage to the product, and malfunction do not occur.
- Performing the work in the unpowered state is recommended to avoid electric shock by touching the product and wired parts with the body or tools and to avoid damage to the product and malfunction.

Caution

- If the battery dies, device values are reset to their initial values when the power is turned off. Replace the backup battery before it dies.

Recommended Backup Batteries

Panasonic: BR2032, CR2032A, CR2032B

Murata: CR2032X, CR2032W



This symbol mark means that batteries and accumulators, at their end-of life, should be disposed of separately from your household waste. If a chemical symbol is printed beneath the symbol shown above, this chemical symbol means that the battery or accumulator contains a heavy metal at a certain concentration. This will be indicated as follows:

Hg : Mercury (0.0005%) Cd : Cadmium (0.002%) Pb : Lead (0.004%)

In the European Union there are separate collection systems for used batteries and accumulators.

Please dispose of batteries and accumulators correctly in accordance with each country or local regulation.

Connection Restrictions When Expanding the PLC

Connection Restrictions When Expanding the PLC

Expansion modules, the HMI module, the cartridge base module, and cartridges on the basic expansion side operate with the internal power supply that is supplied from the CPU module or the expansion interface remote slave module. Expansion modules on the expansion interface side operate with the internal power supply that is supplied from the expansion interface module (expander).

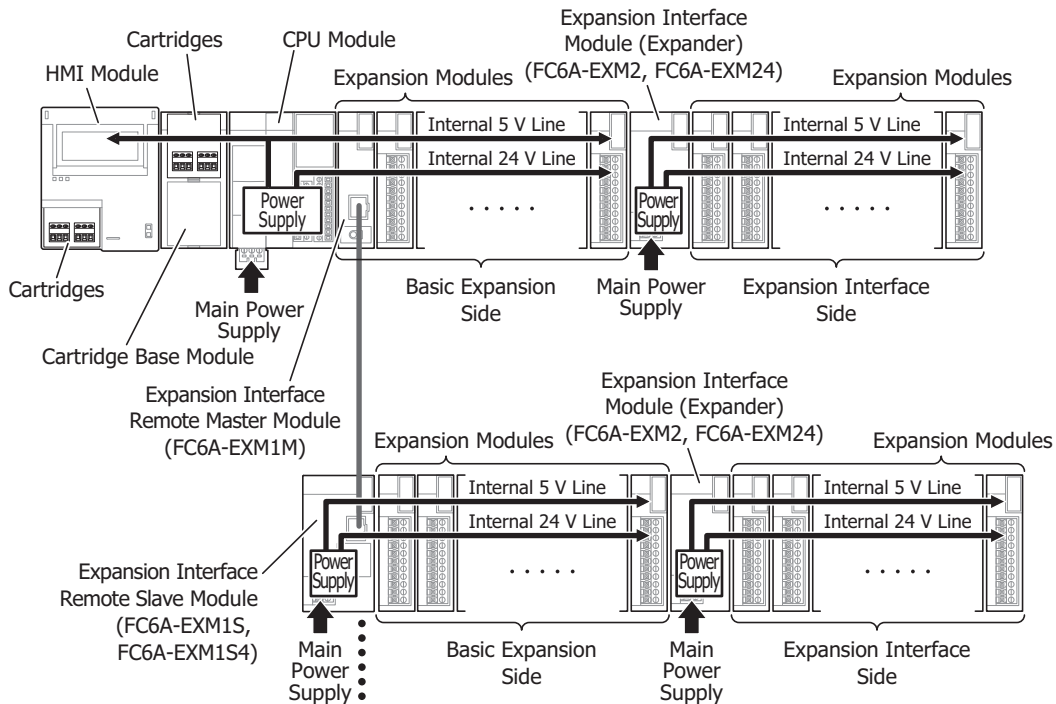

The internal power supply current that can be supplied to the expansion modules on the basic expansion side, HMI module, cartridge base module, and cartridges depends on the module supplying the power. Ensure that the total amount of current for the expansion modules on the basic expansion side, HMI module, cartridge base module, and cartridges does not exceed the limit of the internal power supply that can be supplied.

Notes:

- A maximum of eight expansion modules can be connected on the expansion interface side, regardless of the internal power supply current that can be supplied from the CPU module or the expansion interface remote slave module.
- Expansion modules require an I/O external power supply.

3: INSTALLATION AND WIRING

Connecting Modules to the CPU Module

The internal power supply current that can be supplied from the CPU module to the expansion modules on the basic expansion side, HMI module, cartridge base module, and cartridges is as follows.

CPU Module		Maximum Number of Modules That Can Be Connected to the CPU Module						
		Expansion Modules (basic expansion side) ^{*1}	HMI Module		Cartridge Base Module		CPU Module Unit	
				Cartridges		Cartridges		Cartridges
All-in-One CPU module	16-I/O type	4 ^{*2}	1	1 ^{*3}	—	—	—	1
	24-I/O type	7 ^{*2}	1	1 ^{*3}	—	—	—	1
	40-I/O type	7 ^{*2}	1	1 ^{*3}	—	—	—	2
CAN J1939 All-in-One CPU module	40-I/O type	7 ^{*2}	1	1 ^{*3}	—	—	—	2
Plus CPU module	Plus 16-I/O type	7 ^{*2*4}	1	1	1	2	—	—
	Plus 32-I/O type							



CPU Module		Internal Power Supply Current That Can Be Supplied from the CPU Module			
		Internal 5 V Line Total ^{*5}		Internal 24 V Line Total ^{*6}	
		Ambient Operating Temperature (-10 to 55°C)	Expanded Ambient Operating Temperature (-25 to 10°C, 55 to 65°C)	Ambient Operating Temperature (-10 to 55°C)	Expanded Ambient Operating Temperature (-25 to 10°C, 55 to 65°C)
All-in-One CPU module	16-I/O type	≤ 695 mA	≤ 347 mA	≤ 126 mA	≤ 63 mA
	24-I/O type	≤ 890 mA	≤ 445 mA	≤ 167 mA	≤ 83 mA
	40-I/O type	≤ 1,070 mA	≤ 535 mA	≤ 270 mA	≤ 135 mA
CAN J1939 All-in-One CPU module	40-I/O type	≤ 960 mA	≤ 480 mA	≤ 270 mA	≤ 135 mA
Plus CPU module	Plus 16-I/O type	≤ 1,070 mA	≤ 535 mA	≤ 350 mA	≤ 175 mA
	Plus 32-I/O type				

*1 The number of modules that can be connected on the basic expansion side does not include the expansion interface module (expander). When using the expansion interface module (expander), add the following current.

Module Type	Model	Internal 5 V Line Current
Expansion interface module (expander)	FC6A-EXM2, FC6A-EXM24	20 mA

*2 Only the following number of communication modules can be connected to the CPU module, regardless of the internal power supply current that can be supplied from the CPU module.

Module Type	Maximum No. of Modules (Total on Basic Expansion and Expansion Interface Sides)
All-in-One CPU module	3
CAN J1939 All-in-One CPU module	3
Plus CPU module	15

*3 Only an analog I/O cartridge can be connected.

*4 When an expansion interface remote master module (FC6A-EXM1M) is connected to the basic expansion side, a maximum of five modules can be connected on the basic expansion side.

*5 The internal power supply for the internal 5 V line is used to run the expansion modules (basic expansion side), the HMI module, and the cartridges. Calculate the total current that is used by the modules and ensure that the limit is not exceeded. Use caution because the upper limits differ with expanded ambient operating temperatures (-25 to -10°C and 55 to 65°C). For details, see "Internal Power Supply Current of the Modules and Cartridges" on page 3-39.

*6 The internal power supply for the internal 24 V line is used to drive the output module relays and transistors. Calculate the total current when the outputs are simultaneously ON with the following values as the current per output and ensure that the limit is not exceeded. Use caution because the upper limits differ with expanded ambient operating temperatures (-25 to -10°C and 55 to 65°C).

- Relay output: 6 mA/point
- Transistor output: 1.5 mA/point

Connecting Modules to the Expansion Interface Remote Slave Module

A maximum of seven expansion modules can be connected on the basic expansion side, regardless of the internal power supply current that can be supplied from the expansion interface remote slave module.



Caution

The CPU module cannot detect the internal power supply current that the expansion modules are using. Observe the restrictions in this section because malfunction or failure may result if the FC6A Series MICROSmart is continuously used when the current exceeds the limit.

Internal Power Supply Current of the Modules and Cartridges

Module Type		Model	Internal 3.3 V Line Current*1	Internal 5 V Line Current	Internal 24 V Line Current
Digital I/O module	Digital input module	FC6A-N08B1/FC6A-N08B4	—	30 mA	—
		FC6A-N16B1/FC6A-N16B4	—	40 mA	—
		FC6A-N16B3	—	40 mA	—
		FC6A-N32B3	—	65 mA	—
		FC6A-N08A11/FC6A-N08A14	—	40 mA	—
	Digital output module	FC6A-R081/FC6A-R084	—	35 mA	6 mA/point
		FC6A-R161/FC6A-R164	—	50 mA	6 mA/point
		FC6A-T08P1/FC6A-T08P4	—	25 mA	1.5 mA/point
		FC6A-T16P1/FC6A-T16P4	—	30 mA	1.5 mA/point
		FC6A-T16P3	—	30 mA	1.5 mA/point
		FC6A-T32P3	—	45 mA	1.5 mA/point
		FC6A-T08K1/FC6A-T08K4	—	25 mA	1.5 mA/point
		FC6A-T16K1/FC6A-T16K4	—	30 mA	1.5 mA/point
		FC6A-T16K3	—	30 mA	1.5 mA/point
	FC6A-T32K3	—	45 mA	1.5 mA/point	
	Digital mixed I/O module	FC6A-M08BR1/FC6A-M08BR4	—	30 mA	6 mA/point
		FC6A-M24BR1/FC6A-M24BR4	—	55 mA	6 mA/point
	Analog I/O module	Analog input module	FC6A-J2C1/FC6A-J2C4	—	40 mA
FC6A-J4A1/FC6A-J4A4			—	45 mA	—
FC6A-J8A1/FC6A-J8A4			—	40 mA	—
FC6A-J4CN1/FC6A-J4CN4			—	50 mA	—
FC6A-J4CH1Y/FC6A-J4CH4Y			—	50 mA	—
FC6A-J8CU1/FC6A-J8CU4			—	45 mA	—
Analog output module		FC6A-K2A1/FC6A-K2A4	—	40 mA	—
		FC6A-K4A1/FC6A-K4A4	—	50 mA	—
Analog mixed I/O module		FC6A-L03CN1/FC6A-L03CN4	—	55 mA	—
		FC6A-L06A1/FC6A-L06A4	—	60 mA	—
PID module		FC6A-F2M1/FC6A-F2M4	—	65 mA	—
		FC6A-F2MR1/FC6A-F2MR4	—	65 mA	—
Serial communication module	FC6A-SIF52/FC6A-SIF524	—	35 mA	35 mA	
Cartridges	Digital I/O cartridge	FC6A-PN4	35mA	—	—
		FC6A-PTK4	35mA	—	—
		FC6A-PTS4	35mA	—	—
	Analog I/O cartridge	FC6A-PJ2A	35mA	—	—
		FC6A-PJ2CP	35mA	—	—
		FC6A-PK2AV	35mA	80 mA	—
		FC6A-PK2AW	35mA	190 mA	—
	Communication cartridge	FC6A-PC1	35mA	10 mA	—
		FC6A-PC3	35mA	60 mA	—
		FC6A-PC4	35mA	120 mA	—
Cartridge base module (no installed cartridges)*2	FC6A-HPH1	—	—	—	
HMI module (no installed cartridges)	FC6A-PH1	—	150 mA	15 mA*3	

3: INSTALLATION AND WIRING

Module Type	Model	Internal 3.3 V Line Current*1	Internal 5 V Line Current	Internal 24 V Line Current
HMI module + cartridge	FC6A-PH1+FC6A-PJ2A	—	170 mA	15 mA*3
	FC6A-PH1+FC6A-PJ2CP	—	170 mA	15 mA*3
	FC6A-PH1+FC6A-PK2AV	—	250 mA	15 mA*3
	FC6A-PH1+FC6A-PK2AW	—	360 mA	15 mA*3
	FC6A-PH1+FC6A-PC1	—	180 mA	15 mA*3
	FC6A-PH1+FC6A-PC3	—	230 mA	15 mA*3
	FC6A-PH1+FC6A-PC4	—	290 mA	15 mA*3
	FC6A-PH1+FC6A-PN4	—	175 mA	15 mA*3
	FC6A-PH1+FC6A-PTK4	—	175 mA	15 mA*3
	FC6A-PH1+FC6A-PTS4	—	175 mA	15 mA*3

*1 Not included in the calculation of the connection restriction.

*2 There is no change in the current of the internal power supply for the cartridge base module, even if cartridges are connected.

*3 Current for the backlight. This is not included in the calculation of the connection restriction.

■ Connection Example 1

This example describes the number of connected modules, the internal 5 V line current, and the internal 24 V line current when the expansion modules, HMI module, and cartridges in the below diagram are connected to the 16-I/O type.

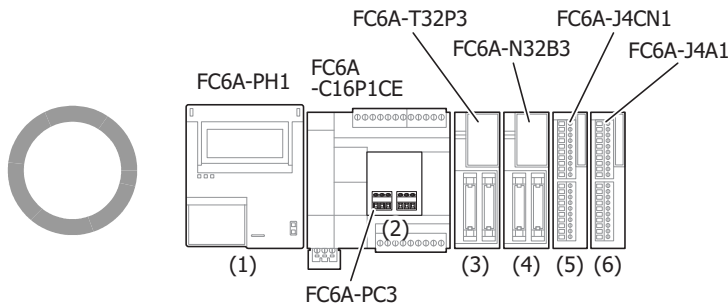

No.	Module Type	Model	Internal 5 V Line Current	Internal 24 V Line Current
(1)	HMI Module (no installed cartridges)	FC6A-PH1	150 mA	—
(2)	Communication Cartridge	FC6A-PC3	60 mA	—
(3)	Digital Output Module	FC6A-T32P3	45 mA	48 mA (= 1.5 mA × 32 points)
(4)	Digital Input Module	FC6A-N32B3	65 mA	—
(5)	Analog Input Module	FC6A-J4CN1	50 mA	—
(6)	Analog Input Module	FC6A-J4A1	45 mA	—
			415 mA (695 mA or lower)	48 mA (126 mA or lower)

- Number of connected modules

For the 16-I/O type, the number of modules that can be connected must be four expansion modules (basic expansion side), one HMI module, and two cartridges or lower. There are four expansion modules (basic expansion side), one HMI module, and one cartridge, so there is no problem because the maximum number of modules was not exceeded.

- Internal 5 V line current

The current must be 695 mA or lower. The total current is 415 mA, so there is no problem because it is not exceeded 695 mA.

- Internal 24 V line current

The current must be 126 mA or lower. The total current is 48 mA, so there is no problem because it is not exceeded 126 mA.

■ Connection Example 2

This example describes the number of connected modules, the internal 5 V Line Current, and the internal 24 V line current when the expansion modules, HMI module, and cartridges in the below diagram are connected to the 40-I/O type.

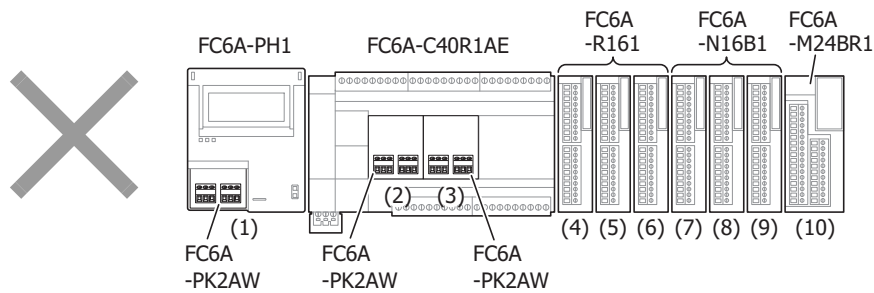

No.	Module Type	Model	Internal 5 V Line Current	Internal 24 V Line Current
(1)	HMI Module + Cartridge	FC6A-PH1 + FC6A-PK2AW	360 mA	—
(2)	Analog I/O Cartridge	FC6A-PK2AW	190 mA	—
(3)	Analog I/O Cartridge	FC6A-PK2AW	190 mA	—
(4)	Digital Output Module	FC6A-R161	50 mA	96 mA (= 6 mA × 16 points)
(5)	Digital Output Module	FC6A-R161	50 mA	96 mA (= 6 mA × 16 points)
(6)	Digital Output Module	FC6A-R161	50 mA	96 mA (= 6 mA × 16 points)
(7)	Digital Input Module	FC6A-N16B1	40 mA	—
(8)	Digital Input Module	FC6A-N16B1	40 mA	—
(9)	Digital Input Module	FC6A-N16B1	40 mA	—
(10)	Digital Mixed I/O Module	FC6A-M24BR1	55 mA	48 mA (= 6 mA × 8 points)
			1,065 mA (1,070 mA or lower)	336 mA (270 mA or lower)

- Number of connected modules
For the 40-I/O type, the number of modules that can be connected must be seven expansion modules (basic expansion side), one HMI module, and three cartridges or lower. There are seven expansion modules (basic expansion side), one HMI module, and two cartridges, so there is no problem because the maximum number of modules was not exceeded.
- Internal 5 V line current
The current must be 1,070 mA or lower. The total current is 1,065 mA, so there is no problem because it does not exceed 1,070 mA.
- Internal 24 V line current
The current must be 270 mA or lower. The total current is 336 mA, which exceeds 270 mA.
Program the PLC so that 45 or fewer relay outputs turn ON simultaneously (270 mA or lower = 6 mA × 45 points) or use the expansion interface module (FC6A-EXM2, FC6A-EXM24) and connect the digital output modules with an insufficient amount of current to the expansion interface side.

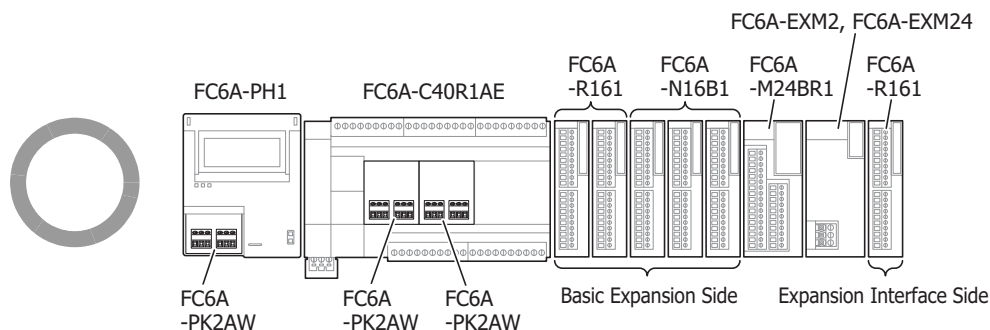

3: INSTALLATION AND WIRING

Calculating the Power Consumed by the Main Power Supply

Calculate the power by referring to the values of the modules given in the table in "Internal Power Supply Current of the Modules and Cartridges" on page 3-39.

■ Examples of Calculating the Power Consumed by Expansion Modules

When the FC6A-R081 is connected to the All-in-One CPU module/CAN J1939 All-in-One CPU module

Calculate the voltage conversion in the CPU module with the following efficiencies.

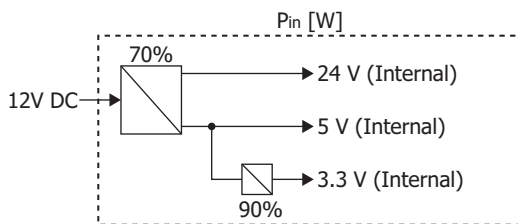
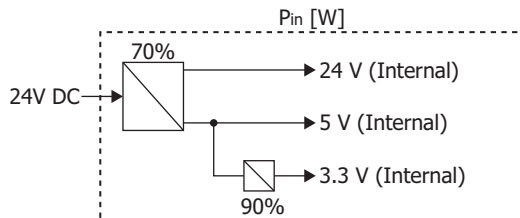
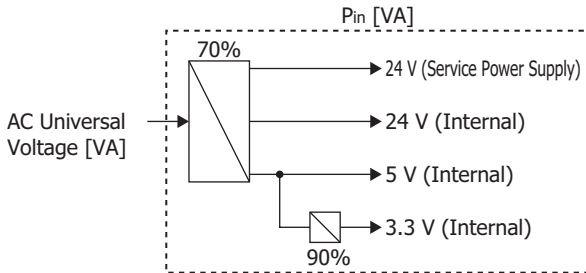

For the FC6A-R081

$$\begin{aligned}
 P_{R081} &= \frac{\overbrace{(I_{out} \times V_{out})}^{5\text{ V}} + \overbrace{(I_{out} \times V_{out})}^{24\text{ V}}}{0.7} \\
 &= \frac{\left(\frac{0\text{ A} \times 3.3\text{ V}}{0.9 \times 5\text{ V}}\right) + (0.035\text{ A} \times 5\text{ V}) + (0.006\text{ A} \times 8\text{ points} \times 24\text{ V})}{0.7} \\
 &\approx 1.9\text{ [W]}
 \end{aligned}$$

When the FC6A-R081 or FC6A-PC4 is connected to the Plus CPU module or an expansion interface module
 Calculate the voltage conversion in the CPU module and expansion interface module with the following efficiencies.

Plus CPU module

Expansion interface module (Expander) (FC6A-EXM2, FC6A-EXM24)
 Expansion interface module (remote master/slave) (FC6A-EXM1M, FC6A-EXM1S, FC6A-EXM1S4)

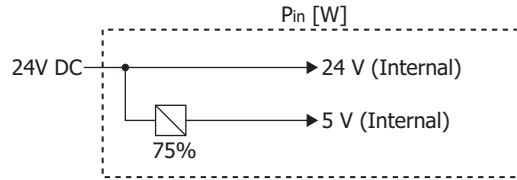
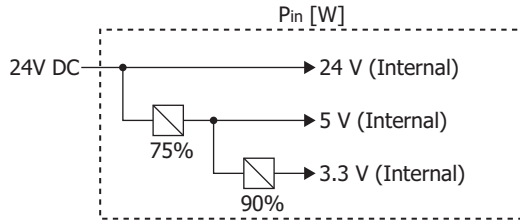

For the FC6A-R081

$$P_{R081} = \frac{\left(\frac{I_{out} \times V_{out}}{0.75} \right) + (I_{out} \times 24 \text{ V})}{0.75} + (0.006 \text{ A} \times 8 \text{ points} \times 24 \text{ V})$$

$$= \frac{\left(\frac{0 \text{ A} \times 3.3 \text{ V}}{0.9 \times 5 \text{ V}} \right) + (0.035 \text{ A} \times 5 \text{ V})}{0.75} + (0.006 \text{ A} \times 8 \text{ points} \times 24 \text{ V})$$

$$\approx 1.39 \text{ [W]}$$

For the FC6A-PC4*1

$$P_{PC4} = \frac{\left\{ \left(\frac{I_{out} \times 3.3 \text{ V}}{0.9 \times 5 \text{ V}} \right) + I_{out} \right\} \times 5 \text{ V}}{0.75}$$

$$= \frac{\left\{ \left(\frac{0.035 \text{ A} \times 3.3 \text{ V}}{0.9 \times 5 \text{ V}} \right) + 0.12 \text{ A} \right\} \times 5 \text{ V}}{0.75}$$

$$\approx 0.97 \text{ [W]}$$

*1 Cartridges cannot be connected to expansion interface modules.

Example 1 of Calculating the Power Consumed by the Main Power Supply

This example shows how to calculate the power consumed by the main power supply when the expansion module, HMI module, and cartridge in the below diagram are connected to the 16-I/O type.

Example:

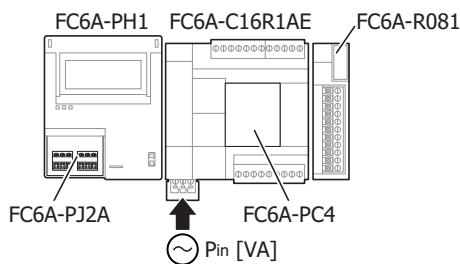

FC6A-C16R1AE : 33 [VA] when alone*1

FC6A-PC4 : $\frac{\left\{ \left(\frac{0.035 \text{ A} \times 3.3 \text{ V}}{0.9 \times 5 \text{ V}} \right) + 0.12 \text{ A} \right\} \times 5 \text{ V}}{0.7} \approx 1.04 \text{ [VA]}$

FC6A-R081 : $\frac{(0.035 \text{ A} \times 5 \text{ V}) + (0.006 \times 8 \text{ points} \times 24 \text{ V})}{0.7} \approx 1.9 \text{ [VA]}$

FC6A-PH1 + FC6A-PJ2A : $\frac{(0.17 \text{ A} \times 5 \text{ V}) + (0.015 \text{ A} \times 24 \text{ V})}{0.7} \approx 1.73 \text{ [VA]}$

↓

$$P_{in} \approx 33 + 1.04 + 1.9 + 1.73$$

$$\approx 37.67 \text{ [VA]}$$

*1 For the power consumption of each CPU module alone, see "Product Specifications" on page 2-1.

3: INSTALLATION AND WIRING

The power consumed by the main power supply will differ if the CPU module is different, even if the system configuration is the same.

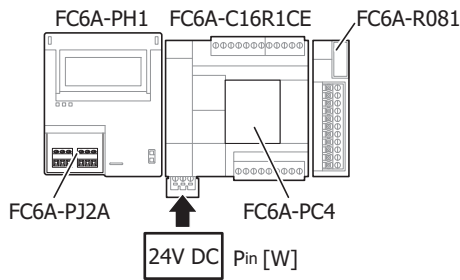

FC6A-C16R1CE	:	3.36 [W] when alone ^{*1}
FC6A-PC4	:	≈ 1.04 [W]
FC6A-R081	:	≈ 1.9 [W]
FC6A-PH1 + FC6A-PJ2A	:	≈ 1.73 [W]

$$\begin{aligned}
 P_{in} &\approx 3.36 + 1.04 + 1.9 + 1.73 \\
 &\approx 8.03 \text{ [W]}
 \end{aligned}$$

*1 For the power consumption of each CPU module alone, see "Product Specifications" on page 2-1.

■ Example 2 of Calculating the Power Consumed by the Main Power Supply

This example shows how to calculate the power consumed by the main power supply when the expansion modules and cartridge in the below diagram are connected to the Plus 16-I/O type.

Example:

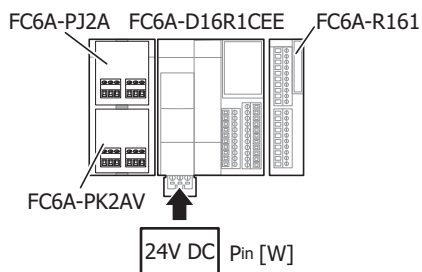

FC6A-D16R1CEE	:	2.88 [W] when alone ^{*1}
FC6A-PJ2A	:	$= \frac{(0.035 \text{ A} \times 3.3 \text{ V})}{0.9 \times 5 \text{ V}} \times 5 \text{ V} \approx 0.17 \text{ [W]}$
FC6A-PK2AV	:	$= \frac{\left\{ \frac{(0.035 \text{ A} \times 3.3 \text{ V})}{0.9 \times 5 \text{ V}} + 0.08 \text{ A} \right\} \times 5 \text{ V}}{0.75} \approx 0.7 \text{ [W]}$
FC6A-R161	:	$= \frac{0.05 \text{ A} \times 5 \text{ V}}{0.75} + (0.006 \text{ A} \times 16 \text{ points} \times 24 \text{ V}) \approx 2.64 \text{ [W]}$

$$\begin{aligned}
 P_{in} &\approx 2.88 + 0.17 + 0.7 + 2.64 \\
 &\approx 6.39 \text{ [W]}
 \end{aligned}$$

*1 For the power consumption of each CPU module alone, see "Product Specifications" on page 2-1.

Terminal Connection

This section describes types of terminals and how to use them.

- When connecting stranded wire or multiple solid wires to a terminal block, use appropriate ferrule for the terminal block. For details, see "Recommended Ferrule List" on page 3-46.
- 1-wire and 2-wire ferrules can be used with the FC6A Series MICROSmart.

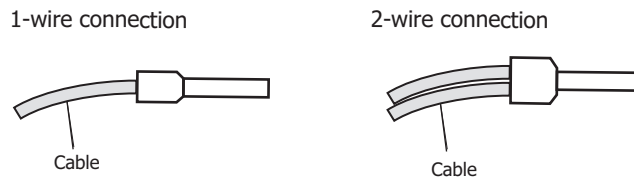

Terminals for Terminal Blocks

Crimp ferrules using an appropriate tool according to the size of ferrules. Cut the end of the wire to the same length or about 0.5 mm longer than the ferrule.

Ensure that the core wire does not protrude at the end of the shield and there are no whiskers.

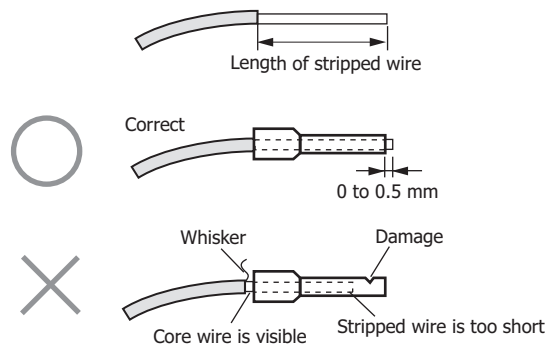

- The thickness and stripping length of stranded wire and single wire differs according to the connectors that will be used. For wire thickness, see "Recommended Ferrule List" on page 3-46.
- Single wire assumes the use of one wire. Do not attach two or more wires to the one connector hole.
- When using single wires, you do not need to use ferrules.

3: INSTALLATION AND WIRING

Recommended Ferrule List

The following ferrules can be used with the FC6A Series MICROSmart.

The recommended ferrules are manufactured by Phoenix Contact (top) or Weidmüller (bottom).

■ All-in-One CPU module/CAN J1939 All-in-One CPU module

CPU Module Terminals				Power Supply Terminals		Input Terminals Output Terminals		CAN Port (CAN J1939 All-in-One CPU module only)	
Wire Type				UL1007 UL2464 Equivalent	UL1015 Equivalent	UL1007 UL2464 Equivalent	UL1015 Equivalent	UL1007 UL2464 Equivalent*1	UL1015 Equivalent*1
Stripping length (mm)				7		7		10	
Wire thickness (mm ²)				0.2 to 2.5		0.2 to 2.5		0.2 to 2.5	
Wire gauge	AWG 24	1-wire usage	AI 0,25- 6 (3203040) H0,25/10 HBL (9025740000)	Yes	—	Yes	—	—	—
			AI 0,25- 8 (3203037) H0,25/12T GE (9021020000)	Yes	—	Yes	—	—	—
			AI 0,25-10 (3241128) —	—	—	—	—	Yes	—
	AWG22	1-wire usage	AI 0,34- 6 (3203053) H0,34/10 TK (9025750000)	Yes	—	Yes	—	—	—
			AI 0,34- 8 (3203066) H0,34/12 TK (9025770000)	Yes	—	Yes	—	—	—
			AI 0,34-10 (3241129) —	—	—	—	—	Yes	—
	AWG20	1-wire usage	AI 0,5- 6 (3200687) H0,5/12D W (9019000000)	Yes	—	Yes	—	—	—
			AI 0,5- 8 (3200014) H0,5/14D W (9019010000)	Yes	—	Yes	—	—	—
			AI 0,5- 8 GB (1208966) —	—	Yes	—	Yes	—	—
			AI 0,5-10 (3201275) H0,5/16D W (9019020000)	—	—	—	—	Yes	—
			AI 0,5-10 GB (3203150) H0,5/16 DS W (9020910000)	—	—	—	—	—	Yes
		2-wire usage	AI-TWIN 2 x 0,5-8 (3200933) H0,5/14D ZH W (9037380000)	Yes	—	Yes	—	—	—
			AI-TWIN 2 x 0,5-10 (3203309) H0,5/16D ZH W (9037390000)	—	—	—	—	Yes	—
	AWG18	1-wire usage	AI 0,75- 6 (3200690) H0,75/12D GR (9019030000)	Yes	—	Yes	—	—	—
			AI 0,75- 8 (3200519) H0,75/14D GR (9019040000)	Yes	—	Yes	—	—	—
			AI 0,75-10 (3201288) H0,75/16D GR (9019050000)	—	—	—	—	Yes	—
			AI 1-8 (3200030) H1,0/14D R (9019080000)	—	Yes	—	Yes	—	—
			AI 1-10 (3200182) H1,0/16D R (9019100000)	—	—	—	—	—	Yes
		2-wire usage	AI-TWIN 2 x 0,75-8 (3200807) H0,75/14D ZH GR (9037410000)	Yes	—	Yes	—	—	—
	AI-TWIN 2 x 0,75-10 (3200975) H0,75/16D ZH GR (9037420000)		—	—	—	—	Yes	—	
	AWG16	1-wire usage	AI 1,5- 6 (3200755) —	Yes	Yes	Yes	Yes	—	—
			AI 1,5- 8 (3200043) H1,5/14D SW (9019120000)	Yes	Yes	Yes	Yes	—	—
			AI 1,5-10 (3200195) H1,5/16D SW (9019130000)	—	—	—	—	Yes	Yes
		2-wire usage	AI-TWIN 2 x 1,5-8 (3200823) H1,5/16D ZH SW (9037470000)	Yes	Yes	Yes	Yes	—	—

CPU Module Terminals		Power Supply Terminals		Input Terminals Output Terminals		CAN Port (CAN J1939 All-in-One CPU module only)	
Wire Type		UL1007 UL2464 Equivalent	UL1015 Equivalent	UL1007 UL2464 Equivalent	UL1015 Equivalent	UL1007 UL2464 Equivalent*1	UL1015 Equivalent*1
Screwdriver	SZS 0.4x2.5 (1205037) SDS 0.4X2.5X75 (9009030000)	—		—		—	
	SZS 0.6x3.5 (1205053) SDS 0.6X3.5X100 (9008330000)	Yes		Yes		Yes	
Tightening torque (N)		0.51		0.51		0.51	

*1 For the wires that can be used, see "Wiring the CAN J1939 Bus" on page 3-52.

■ Plus CPU module

CPU Module Terminals				Power Supply Terminals		Input Terminals/Output Terminals (FC6A-D16R1CEE, FC6A-D16K1CEE, FC6A-D16P1CEE, FC6A-D16R4CEE, FC6A-D16K4CEE, FC6A-D16P4CEE only)	
Wire Type				UL1007 UL2464 Equivalent	UL1015 Equivalent	UL1007 UL2464 Equivalent	UL1015 Equivalent
Stripping length (mm)				7		9	
Wire thickness (mm ²)				0.2 to 2.5		0.14 to 1.50	
Wire gauge	AWG 24	1-wire usage	AI 0,25- 6 (3203040) H0,25/10 HBL (9025740000)	Yes	—	—	—
			AI 0,25- 8 (3203037) H0,25/12T GE (9021020000)	Yes	—	Yes	—
			AI 0,25-10 (3241128) —	—	—	Yes	—
	AWG22	1-wire usage	AI 0,34- 6 (3203053) H0,34/10 TK (9025750000)	Yes	—	—	—
			AI 0,34- 8 (3203066) H0,34/12 TK (9025770000)	Yes	—	Yes	—
			AI 0,34-10 (3241129) —	—	—	Yes	—
	AWG20	1-wire usage	AI 0,5- 6 (3200687) H0,5/12D W (9019000000)	Yes	—	—	—
			AI 0,5- 8 (3200014) H0,5/14D W (9019010000)	Yes	—	Yes	—
			AI 0,5- 8 GB (1208966) —	—	Yes	—	Yes
			AI 0,5-10 (3201275) H0,5/16D W (9019020000)	—	—	Yes	—
			AI 0,5-10 GB (3203150) H0,5/16 DS W (90202910000)	—	—	—	Yes
		2-wire usage	AI-TWIN 2 x 0,5-8 (3200933) H0,5/14D ZH W (9037380000)	Yes	—	—	—
			AI-TWIN 2 x 0,5-10 (3203309) H0,5/16D ZH W (9037390000)	—	—	Yes	—
	AWG18	1-wire usage	AI 0,75- 6 (3200690) H0,75/12D GR (9019030000)	Yes	—	—	—
			AI 0,75- 8 (3200519) H0,75/14D GR (9019040000)	Yes	—	—	—
			AI 0,75-10 (3201288) H0,75/16D GR (9019050000)	—	—	—	—
			AI 1-8 (3200030) H1,0/14D R (9019080000)	—	Yes	—	—
			AI 1-10 (3200182) H1,0/16D R (9019100000)	—	—	—	—
		2-wire usage	AI-TWIN 2 x 0,75-8 (3200807) H0,75/14D ZH GR (9037410000)	Yes	—	—	—
			AI-TWIN 2 x 0,75-10 (3200975) H0,75/16D ZH GR (9037420000)	—	—	—	—

3: INSTALLATION AND WIRING

CPU Module Terminals				Power Supply Terminals		Input Terminals/Output Terminals (FC6A-D16R1CEE, FC6A-D16K1CEE, FC6A-D16P1CEE, FC6A-D16R4CEE, FC6A-D16K4CEE, FC6A-D16P4CEE only)	
Wire Type				UL1007 UL2464 Equivalent	UL1015 Equivalent	UL1007 UL2464 Equivalent	UL1015 Equivalent
Wire gauge	AWG16	1-wire usage	AI 1,5- 6 (3200755) —	Yes	Yes	—	—
			AI 1,5- 8 (3200043) H1,5/14D SW (9019120000)	Yes	Yes	—	—
			AI 1,5-10 (3200195) H1,5/16D SW (9019130000)	—	—	—	—
	2-wire usage	AI-TWIN 2 x 1,5-8 (3200823) H1,5/16D ZH SW (9037470000)	Yes	Yes	—	—	
Screwdriver			SZS 0.4×2.5 (1205037) SDS 0.4X2.5X75 (9009030000)	—		Yes	
			SZS 0.6×3.5 (1205053) SDS 0.6X3.5X100 (9008330000)	Yes		—	
Tightening torque (N)				0.51		0.28	

■ Expansion Modules, Expansion Interface Module (Expander), and Expansion Interface Remote Slave Module

Expansion Modules, Expansion Interface Module (Expander), and Expansion Interface Remote Slave Module Terminal Block Types				3.81 mm Pitch		5.08 mm Pitch	
Model				FC6A-N16B1, FC6A-R161, FC6A-T16K1, FC6A-T16P1, FC6A-M24BR1, FC6A-J4A1, FC6A-J8A1, FC6A-L06A1, FC6A-J4CN1, FC6A-J4CH1Y, FC6A-J8CU1, FC6A-F2M1, FC6A-F2MR1, FC6A-SIF52,	FC6A-N16B4, FC6A-R164, FC6A-T16K4, FC6A-T16P4, FC6A-M24BR4, FC6A-J4A4, FC6A-J8A4, FC6A-L06A4, FC6A-J4CN4, FC6A-J4CH4Y, FC6A-J8CU4, FC6A-F2M4, FC6A-F2MR4, FC6A-SIF524	FC6A-N08B1, FC6A-N08B4, FC6A-N08A11, FC6A-N08A14, FC6A-R081, FC6A-R084, FC6A-T08K1, FC6A-T08K4, FC6A-T08P1, FC6A-T08P4, FC6A-M08BR1, FC6A-M08BR4, FC6A-J2C1, FC6A-J2C4, FC6A-K2A1, FC6A-K2A4, FC6A-K4A1, FC6A-K4A4, FC6A-L03CN1, FC6A-L03CN4, FC6A-EXM2, FC6A-EXM24, FC6A-EXM1S, FC6A-EXM1S4	
Wire Type				UL1007 UL2464 Equivalent	UL1015 Equivalent	UL1007 UL2464 Equivalent	UL1015 Equivalent
Stripping length (mm)				9		10	
Wire thickness (mm ²)				0.14 to 1.50		0.2 to 2.5	
Wire gauge	AWG 24	1-wire usage	AI 0,25- 6 (3203040) H0,25/10 HBL (9025740000)	—	—	—	—
			AI 0,25- 8 (3203037) H0,25/12T GE (9021020000)	Yes	—	—	—
			AI 0,25-10 (3241128) —	Yes	—	Yes	—
	AWG22	1-wire usage	AI 0,34- 6 (3203053) H0,34/10 TK (9025750000)	—	—	—	—
			AI 0,34- 8 (3203066) H0,34/12 TK (9025770000)	Yes	—	—	—
			AI 0,34-10 (3241129) —	Yes	—	Yes	—

Expansion Modules, Expansion Interface Module (Expander), and Expansion Interface Remote Slave Module Terminal Block Types				3.81 mm Pitch		5.08 mm Pitch	
Model				FC6A-N16B1, FC6A-R161, FC6A-T16K1, FC6A-T16P1, FC6A-M24BR1, FC6A-J4A1, FC6A-J8A1, FC6A-L06A1, FC6A-J4CN1, FC6A-J4CH1Y, FC6A-J8CU1, FC6A-F2M1, FC6A-F2MR1, FC6A-SIF52,	FC6A-N16B4, FC6A-R164, FC6A-T16K4, FC6A-T16P4, FC6A-M24BR4, FC6A-J4A4, FC6A-J8A4, FC6A-L06A4, FC6A-J4CN4, FC6A-J4CH4Y, FC6A-J8CU4, FC6A-F2M4, FC6A-F2MR4, FC6A-SIF524	FC6A-N08B1, FC6A-N08A11, FC6A-R081, FC6A-T08K1, FC6A-T08P1, FC6A-M08BR1, FC6A-J2C1, FC6A-K2A1, FC6A-K4A1, FC6A-L03CN1, FC6A-EXM2, FC6A-EXM1S,	FC6A-N08B4, FC6A-N08A14, FC6A-R084, FC6A-T08K4, FC6A-T08P4, FC6A-M08BR4, FC6A-J2C4, FC6A-K2A4, FC6A-K4A4, FC6A-L03CN4, FC6A-EXM24, FC6A-EXM1S4
Wire Type				UL1007 UL2464 Equivalent	UL1015 Equivalent	UL1007 UL2464 Equivalent	UL1015 Equivalent
Wire gauge	AWG20	1-wire usage	AI 0,5- 6 (3200687) H0,5/12D W (9019000000)	—	—	—	—
			AI 0,5- 8 (3200014) H0,5/14D W (9019010000)	Yes	—	—	—
			AI 0,5- 8 GB (1208966) —	—	Yes	—	—
			AI 0,5-10 (3201275) H0,5/16D W (9019020000)	Yes	—	Yes	—
			AI 0,5-10 GB (3203150) H0,5/16 DS W (9202910000)	—	Yes	—	Yes
		AI-TWIN 2 x 0,5-8 (3200933) H0,5/14D ZH W (9037380000)	—	—	—	—	
	AWG18	1-wire usage	AI 0,75- 6 (3200690) H0,75/12D GR (9019030000)	—	—	—	—
			AI 0,75- 8 (3200519) H0,75/14D GR (9019040000)	—	—	—	—
			AI 0,75-10 (3201288) H0,75/16D GR (9019050000)	—	—	Yes	—
			AI 1-8 (3200030) H1,0/14D R (9019080000)	—	—	—	—
			AI 1-10 (3200182) H1,0/16D R (9019100000)	—	—	—	Yes
		2-wire usage	AI-TWIN 2 x 0,75-8 (3200807) H0,75/14D ZH GR (9037410000)	—	—	—	—
AWG16	1-wire usage	AI 1,5- 6 (3200755) —	—	—	—	—	
		AI 1,5- 8 (3200043) H1,5/14D SW (9019120000)	—	—	—	—	
		AI 1,5-10 (3200195) H1,5/16D SW (9019130000)	—	—	Yes	Yes	
	2-wire usage	AI-TWIN 2 x 1,5-8 (3200823) H1,5/16D ZH SW (9037470000)	—	—	—	—	
	Screwdriver	SZS 0.4x2.5 (1205037) SDS 0.4X2.5X75 (9009030000)		Yes		—	
		SZS 0.6x3.5 (1205053) SDS 0.6X3.5X100 (9008330000)		—		Yes	
Tightening torque (N)				0.28		0.51	

3: INSTALLATION AND WIRING

■ Expansion Interface Remote Master Module, HMI Module, and Cartridge

Module Type				Expansion Interface Remote Master Module		HMI Module		Cartridges	
Wire Type				UL1007 UL2464 Equivalent	UL1015 Equivalent	UL1007 UL2464 Equivalent	UL1015 Equivalent	UL1007 UL2464 Equivalent	UL1015 Equivalent
Stripping length (mm)				7		7		5	
Wire thickness (mm ²)				0.14 to 2.5		0.14 to 2.5		0.14 to 1.50	
Wire gauge	AWG 24	1-wire usage	AI 0,25- 6 (3203040) H0,25/10 HBL (9025740000)	—	—	Yes	—	Yes	—
			AI 0,25- 8 (3203037) H0,25/12T GE (9021020000)	Yes	—	Yes	—	—	—
			AI 0,25-10 (3241128) —	—	—	—	—	—	—
	AWG22	1-wire usage	AI 0,34- 6 (3203053) H0,34/10 TK (9025750000)	—	—	Yes	—	Yes	—
			AI 0,34- 8 (3203066) H0,34/12 TK (9025770000)	Yes	—	Yes	—	—	—
			AI 0,34-10 (3241129) —	—	—	—	—	—	—
Wire gauge	AWG20	1-wire usage	AI 0,5- 6 (3200687) H0,5/12D W (9019000000)	—	—	Yes	—	Yes	—
			AI 0,5- 8 (3200014) H0,5/14D W (9019010000)	Yes	—	Yes	—	—	—
			AI 0,5- 8 GB (1208966) —	—	Yes	—	Yes	—	—
		2-wire usage	AI 0,5-10 (3201275) H0,5/16D W (9019020000)	—	—	—	—	—	—
			AI 0,5-10 GB (3203150) H0,5/16 DS W (9202910000)	—	—	—	—	—	—
			AI-TWIN 2 x 0,5-8 (3200933) H0,5/14D ZH W (9037380000)	Yes	—	Yes	—	—	—
	AWG18	1-wire usage	AI 0,75- 6 (3200690) H0,75/12D GR (9019030000)	—	—	Yes	—	—	—
			AI 0,75- 8 (3200519) H0,75/14D GR (9019040000)	Yes	—	Yes	—	—	—
			AI 0,75-10 (3201288) H0,75/16D GR (9019050000)	—	—	—	—	—	—
		2-wire usage	AI 1-8 (3200030) H1,0/14D R (9019080000)	Yes	—	—	Yes	—	—
			AI 1-10 (3200182) H1,0/16D R (9019100000)	—	—	—	—	—	—
			AI-TWIN 2 x 0,75-8 (3200807) H0,75/14D ZH GR (9037410000)	Yes	—	Yes	—	—	—
AWG16	1-wire usage	AI 1,5- 6 (3200755) —	—	—	Yes	Yes	—	—	
		AI 1,5- 8 (3200043) H1,5/14D SW (9019120000)	Yes	Yes	—	Yes	—	—	
		AI 1,5-10 (3200195) H1,5/16D SW (9019130000)	—	—	—	—	—	—	
	2-wire usage	AI-TWIN 2 x 1,5-8 (3200823) H1,5/16D ZH SW (9037470000)	Yes	—	—	—	—	—	
Screwdriver	SZS 0.4×2.5 (1205037) SDS 0.4×2.5×75 (9009030000)		—	—	—	—	Yes	—	
	SZS 0.6×3.5 (1205053) SDS 0.6×3.5×100 (9008330000)		—	—	Yes	—	—	—	
	SZF 1-0,6×3,5 (1204517) SDS 0.6×3.5×100 (9008330000)		Yes*1	—	—	—	—	—	
Tightening torque (N)				—*2		0.51		0.22 to 0.25	

*1 Used when removing the wires.

*2 Push-in type.

Crimping Tool

The following crimping tool can be used with FC6A Series MICROSmart.

Tool Name	Model Number (Order Number)	
	Phoenix Contact	Weidmüller
Crimping tool	CRIMPFOX 6 (1212034)	PZ 6 Roto L (1444050000)



Caution

- Do not touch live terminals. There is a risk of electric shock.
- When powered, the terminals that are connected to external devices may become hot. Do not touch the terminals immediately after turning the power off.
- Do not touch the power supply terminals immediately after turning the power off. There is a risk of electric shock.
- Insert the wire all the way to the tip of the ferrule and crimp it.
- When connecting stranded wire or multiple wires to a terminal block, use a ferrule. Otherwise there is a risk of wires becoming disconnected.
- When using single wires, you do not need to use ferrules.
- Single wire assumes the use of one wire. Do not attach two or more wires to the one connector hole.

Wiring the CAN J1939 Bus

This section describes the CAN port terminal arrangement, internal equivalent circuit, and specifications.

CAN Port Terminal Arrangement

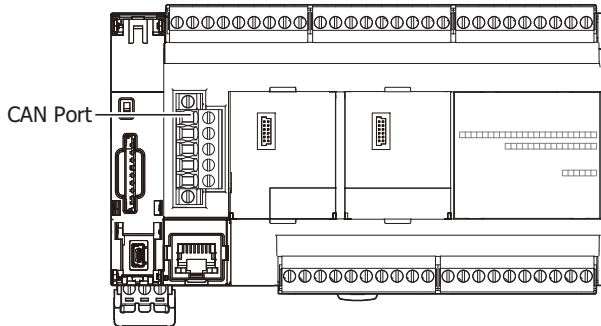

No.	Signal Wire	Details
1	SG	CAN external power supply (-)
2	CAN_L	CAN_L bus line (dominant low)
3	CAN_SHLD	CAN cable shield*1
4	CAN_H	CAN_H bus line (dominant high)
5	(V+)	CAN external power supply (+). (N.C. Not connected internally.)

*1 Internally connected to the SG via a resistor and capacitor connected in a series. (R = 1 Ω, 0.68 μF)

Internal Equivalent Circuit

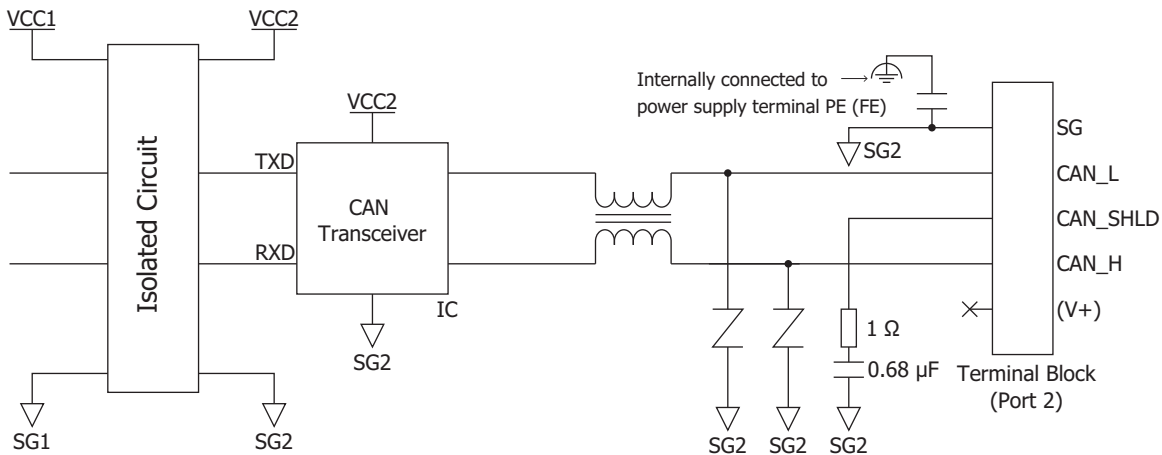

CAN J1939 Wiring

The specifications and wiring examples differ according to CAN protocol standard J1939-11 and J1939-15. Connect terminating resistance (120 Ω, 0.5 W or higher) between CAN_H and CAN_L at both ends of the main line when wiring the CAN port.

CAN Protocol Standard		J1939-11	J1939-15
Communication Speed		250 kbps	
Nodes		30	10
Cable	Wire Configuration	Twisted pair	
		Shielded	Unshielded
	0.3 mm ² to 0.82 mm ² (AWG 22 to 18)		
	Applicable Standards	ISO 11898/1993	
	Characteristic Impedance	120 Ω	
Cable Length		40 m maximum, stub 1 m maximum	40 m maximum, stub 3 m maximum

J1939-11

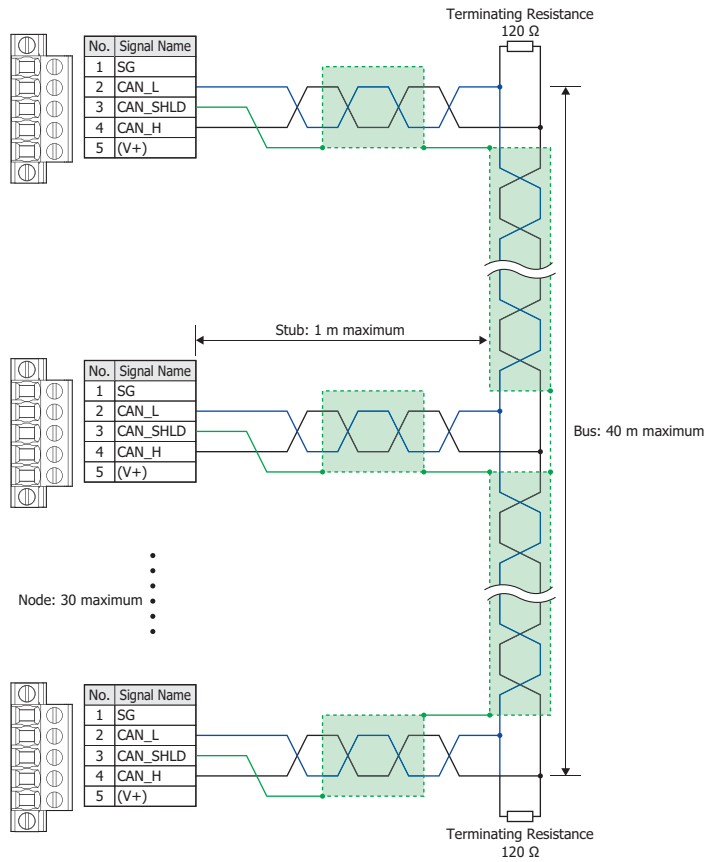

J1939-15

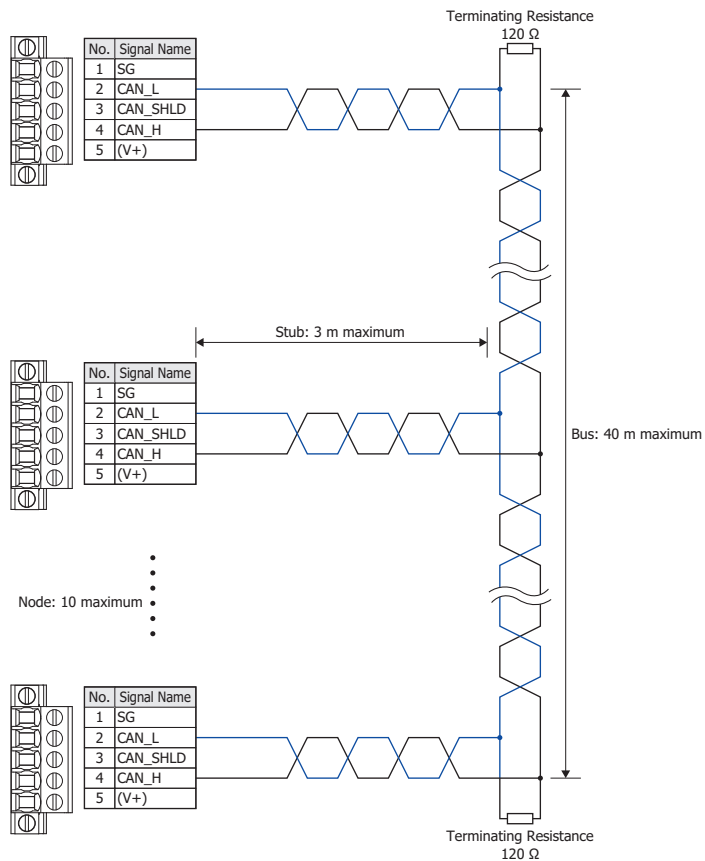

4: OPERATION BASICS

Introduction

The following version of WindLDR is required for FC6A Series MICROSmart programming and maintenance:

- When you use All-in-One CPU module/CAN J1939 All-in-One CPU module: WindLDR version 8.0.0 or later
- When you use Plus CPU module: WindLDR version 8.6.0 or later

For details on how to check the version, see "Checking the WindLDR Version Number" on page 4-16.

This chapter describes basic procedures for operating WindLDR, programming and maintenance software for the FC6A Series MICROSmart.

Start WindLDR

■ Windows 10

Click Start and then **All Apps > IDEC Automation Organizer > WindLDR**.

■ Windows 8

Click **WindLDR** in the tiles on the Start screen.

■ Windows 7

Click **Start** and then **Programs > IDEC Automation Organizer > WindLDR**.

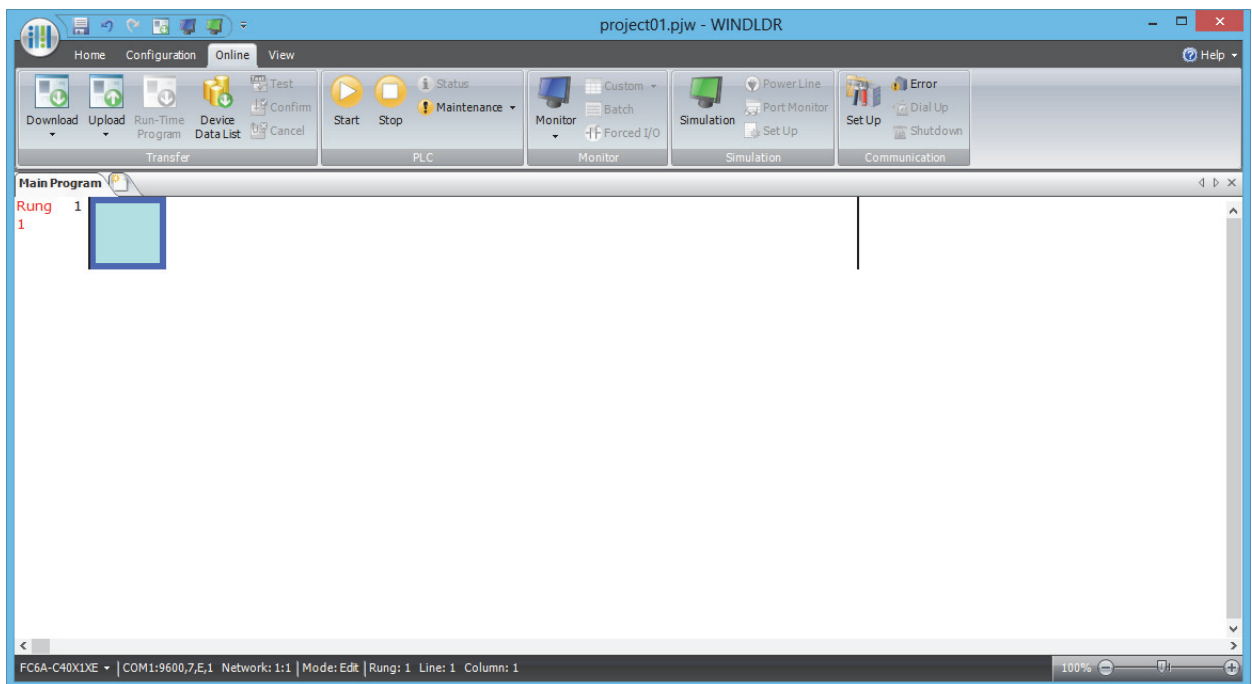

PLC Selection

Before programming a user program on WindLDR, select a PLC type.

1. Select **Configuration** from the WindLDR menu bar, then select **PLC Type**.
The **PLC Selection** dialog box appears.
2. Select a PLC type in the selection box and the programming language to use.
3. Click **OK**.

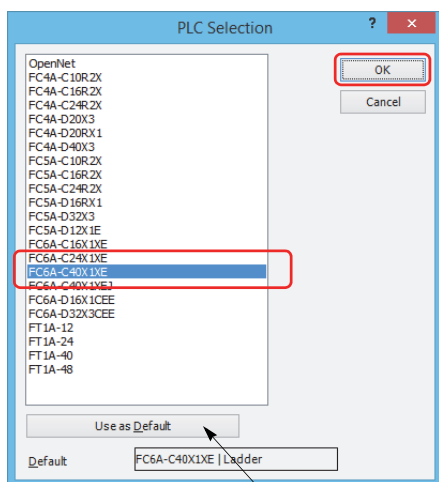

Select the PLC type from the list and click **Use as Default** to set the selected PLC type as the default type when WindLDR starts.

In WindLDR, the FC6A Series MICROSmart is categorized by the number of inputs and outputs and the PLC type names are displayed as follows.

PLC Selection Option	Type No.
FC6A-C16X1XE	FC6A-C16R1AE, FC6A-C16R1CE, FC6A-C16K1CE, F6A-C16P1CE, FC6A-C16R1DE, FC6A-C16K1DE, FC6A-C16P1DE FC6A-C16R4AE, FC6A-C16R4CE, FC6A-C16K4CE, F6A-C16P4CE, FC6A-C16R4DE, FC6A-C16K4DE, FC6A-C16P4DE
FC6A-C24X1XE	FC6A-C24R1AE, FC6A-C24R1CE, FC6A-C24P1CE, FC6A-C24K1CE FC6A-C24R4AE, FC6A-C24R4CE, FC6A-C24P4CE, FC6A-C24K4CE
FC6A-C40X1XE	FC6A-C40R1AE, FC6A-C40R1CE, FC6A-C40P1CE, FC6A-C40K1CE, FC6A-C40R1DE, FC6A-C40P1DE, FC6A-C40K1DE FC6A-C40R4AE, FC6A-C40R4CE, FC6A-C40P4CE, FC6A-C40K4CE, FC6A-C40R4DE, FC6A-C40P4DE, FC6A-C40K4DE
FC6A-C40X1XEJ	FC6A-C40R1AEJ, FC6A-C40R1CEJ, FC6A-C40P1CEJ, FC6A-C40K1CEJ, FC6A-C40R1DEJ, FC6A-C40P1DEJ, FC6A-C40K1DEJ, FC6A-C40R4AEJ, FC6A-C40R4CEJ, FC6A-C40P4CEJ, FC6A-C40K4CEJ, FC6A-C40R4DEJ, FC6A-C40P4DEJ, FC6A-C40K4DEJ
FC6A-D16X1CEE	FC6A-D16R1CEE, FC6A-D16R4CEE, FC6A-D16K1CEE, FC6A-D16K4CEE, FC6A-D16P1CEE, FC6A-D16P4CEE
FC6A-D32X3CEE	FC6A-D32K3CEE, FC6A-D32K4CEE, FC6A-D32P3CEE, FC6A-D32P4CEE

PLC selection is now complete. Next, create a ladder program.

Create Program

Create Ladder Program

This section describes the operating procedure to create a ladder program in WindLDR.

Note: For details about devices, see "Devices" on page 6-1. See the "FC6A Series MICROSmart Ladder Programming Manual" for details on basic and advanced instructions.

Sample User Program

Create a simple program using WindLDR. The sample program performs the following operation:

When only input I0 is turned on, output Q0 is turned on.

When only input I1 is turned on, output Q1 is turned on.

When both inputs I0 and I1 are turned on, output Q2 flashes in 1-s increments.

Rung No.	Input I0	Input I1	Output Operation
1	ON	OFF	Output Q0 is turned ON.
2	OFF	ON	Output Q1 is turned ON.
3	ON	ON	Output Q2 flashes in 1-s increments.

Note: One collection of a group of instructions that control output or advanced instructions is called a rung. WindLDR manages programs in rung units. Function descriptions can be configured as rung comments for individual rungs.

Start WindLDR

From the **Start** menu of Windows, select **Programs > IEC Automation Organizer > WindLDR**.

WindLDR starts and a blank ladder editing screen appears with menus and tool bars shown on top of the screen.

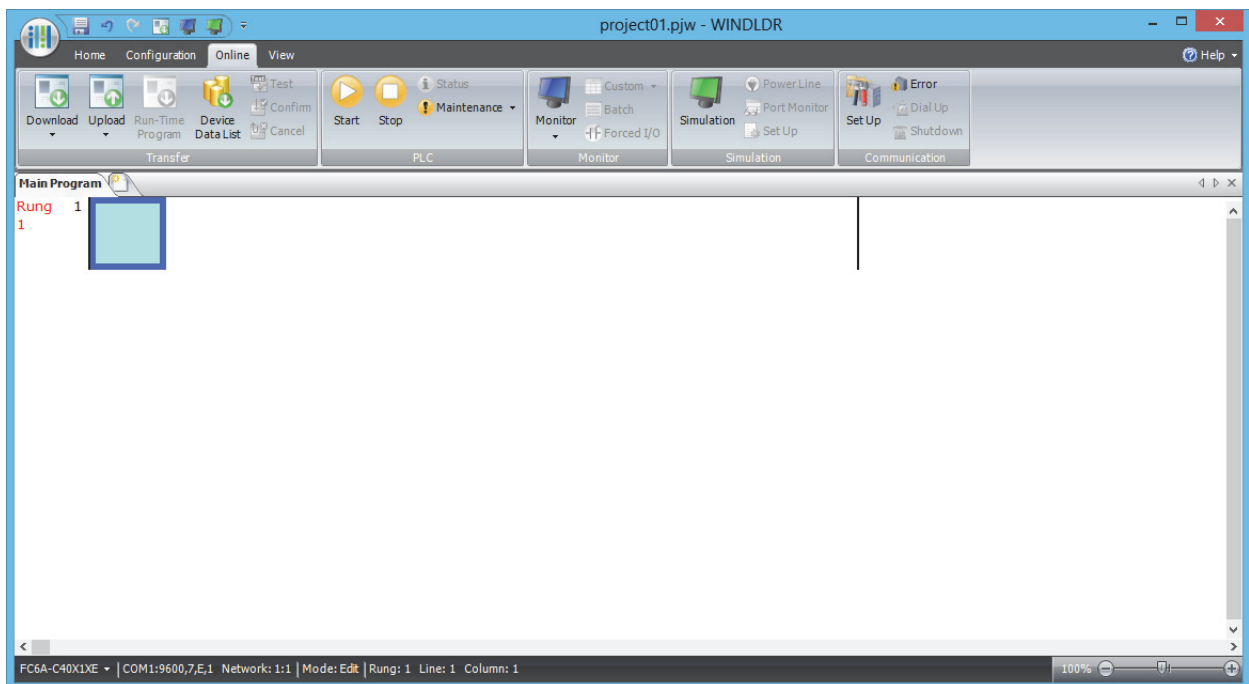

4: OPERATION BASICS

Edit User Program Rung by Rung

Start the user program with the LOD instruction by inserting a NO contact of input I0.

1. From the WindLDR menu bar, select **Home > Basic > A (Normally Open)**.

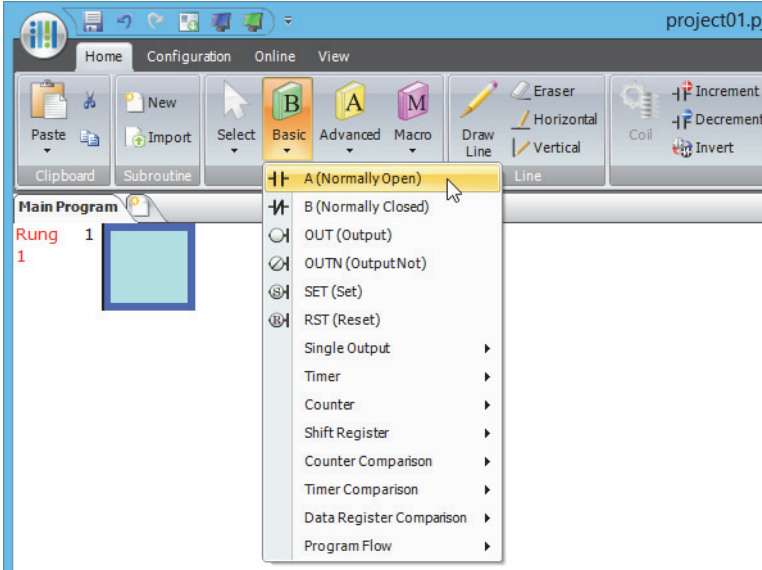

2. Move the mouse pointer to the first column of the first line where you want to insert a NO contact, and click the left mouse button.

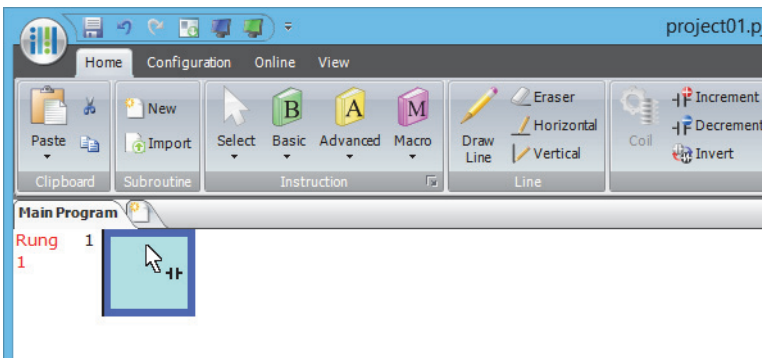

3. Double-click **Normally Open**.
The **A (Normally Open)** dialog box is displayed.

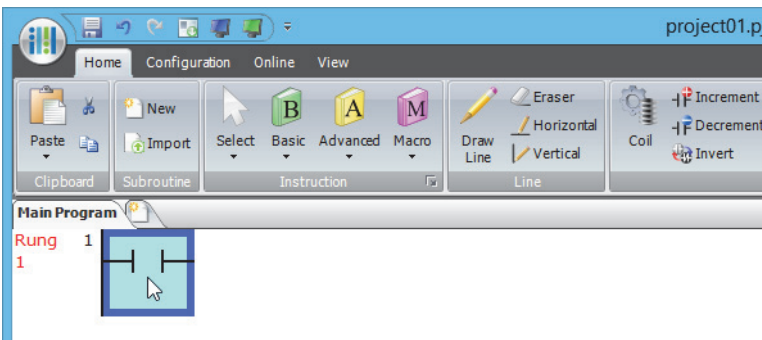

4. Enter **I0** in the **Tag Name** field, and click **OK**.

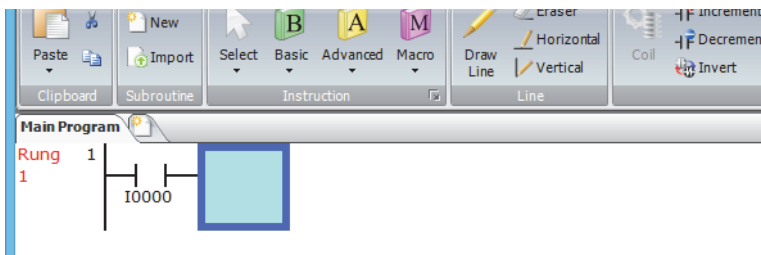
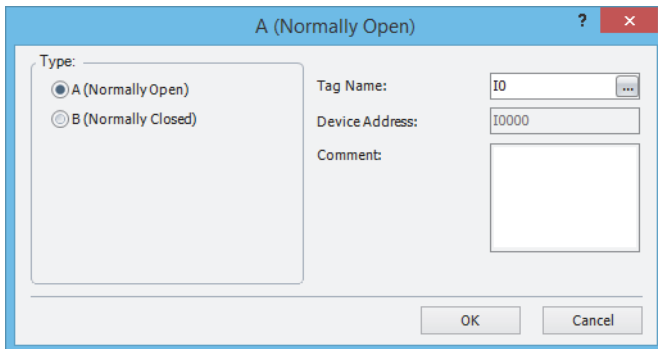

Note:

- To enter an NO contact from the right-click menu, right-click at the location to insert the NO contact, and on the right-click menu, click **Basic Instructions (B)**, then **A (Normally Open)**.
- To enter an NO contact from the keyboard, press **A** to display the **Coil Selection** dialog box. Select **A (Normally Open)**, and then press **[Enter]** (Enter).

A NO contact of input I0 is programmed in the first column of the first ladder line. Next, program the ANDN instruction by inserting a NC contact of input I1.

5. From the WindLDR menu bar, select **Home > Basic > B (Normally Closed)**.
6. Move the mouse pointer to the second column of the first ladder line where you want to insert a NC contact, and click the left mouse button.
7. Double-click **Normally Closed**.
The **B (Normally Closed)** dialog box is displayed.

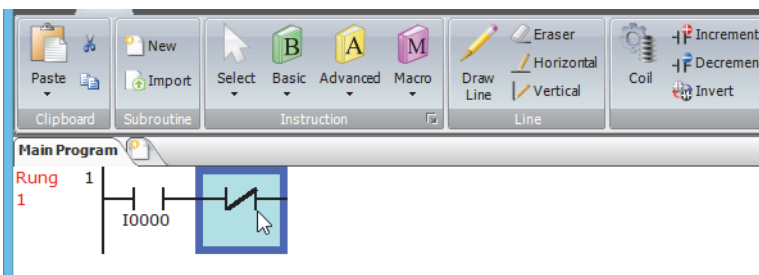

8. Enter **I1** in the Tag Name field, and click **OK**.

An NC contact of input I1 is programmed in the second column of the first ladder line. At the end of the first ladder line, program the OUT instruction by inserting a NO coil of output Q0.

9. From the WindLDR menu bar, select **Home > Basic > OUT (Output)**.
10. Move the mouse pointer to the third column of the first ladder line where you want to insert an output coil, and click the left mouse button.

Note: Another method to insert an instruction (either basic or advanced) is to type the instruction symbol, OUT, where you want to insert the instruction.

4: OPERATION BASICS

11. Double-click **Output**.

The **Out (Output)** dialog box is displayed.

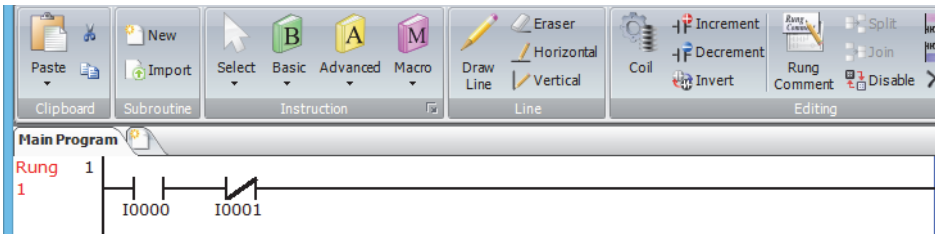

12. Enter **Q0** in the Tag Name field, and click **OK**.

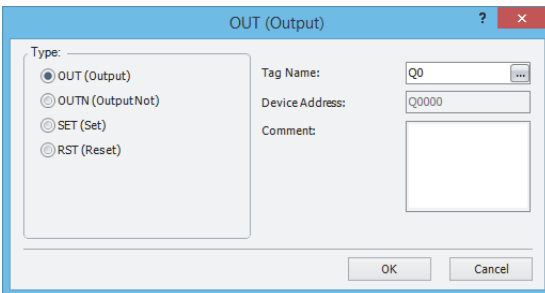

A NO output coil of output Q0 is programmed in the right-most column of the first ladder line. This completes programming for rung 1.

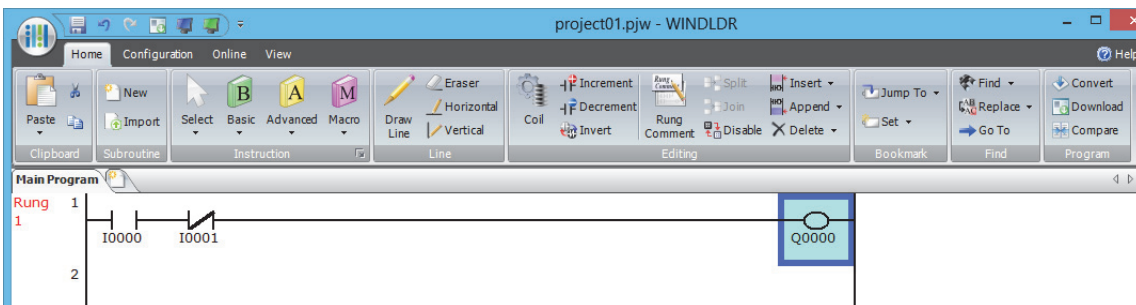

Continue programming for rungs 2 and 3 by repeating similar procedures.

A new rung is inserted by pressing the **Enter** key while the cursor is on the preceding rung. A new rung can also be inserted by selecting **Home > Append > Append a Rung**.

When completed, the ladder program looks like below.

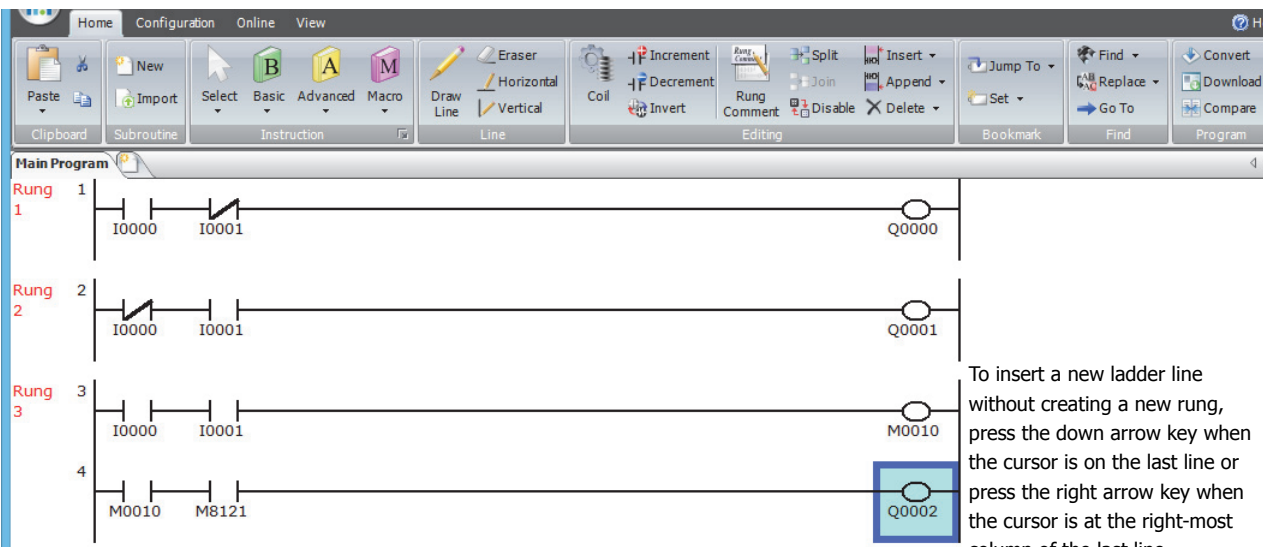

Convert Program

The program can be checked whether it contains any user program syntax error.

From the menu bar, select **Home > Convert (Program group)**.

When the instruction/FB symbols are connected correctly, the program conversion is completed successfully. If any error is found, the errors are listed on the Info Window. Then, make corrections as necessary.

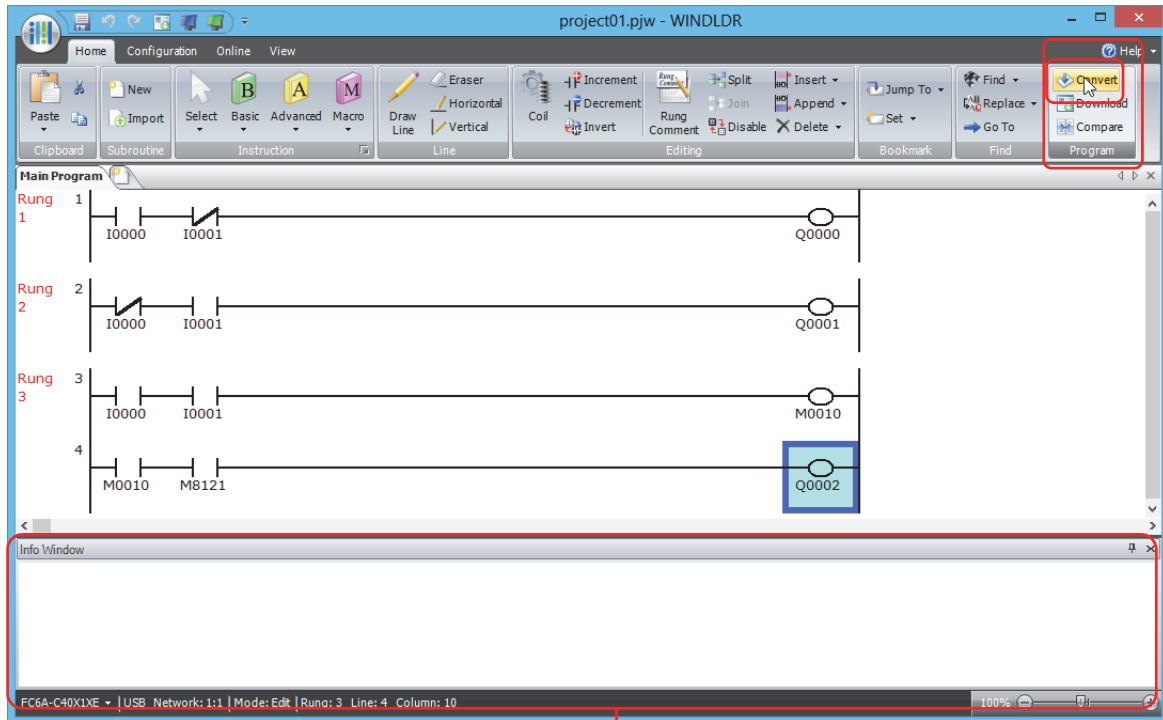

Info Window

Save Project

This section describes the operating procedure to save the created ladder program as a project file.

1. Save the current project with a new name.

Click  (application) button > **Save As** > **WindLDR Project**.

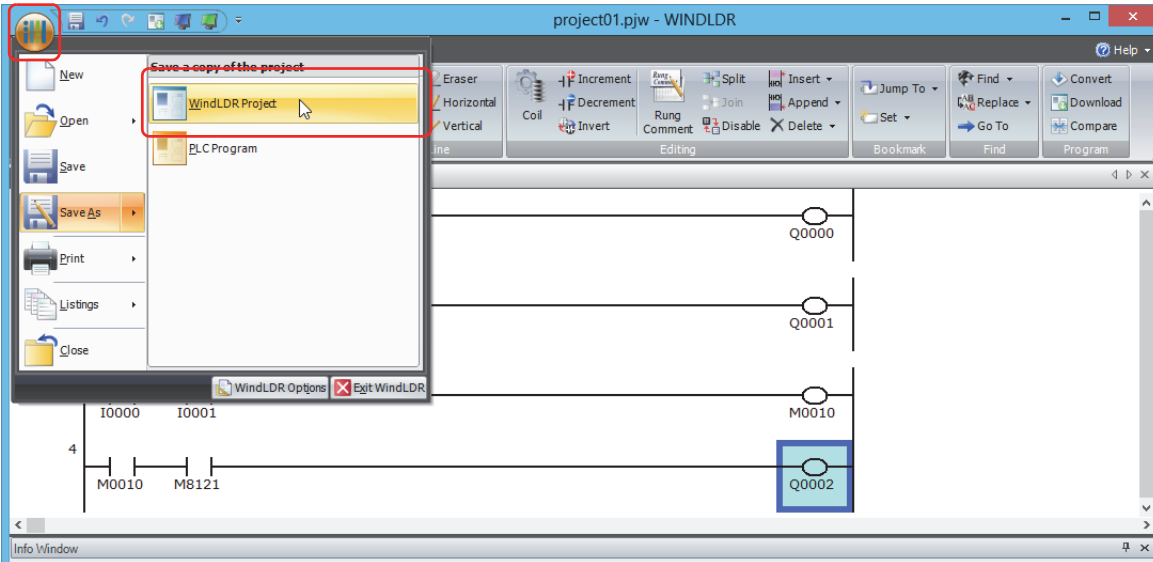

2. Enter the file name in **File name**, specify the folder to save to, and click **Save**.

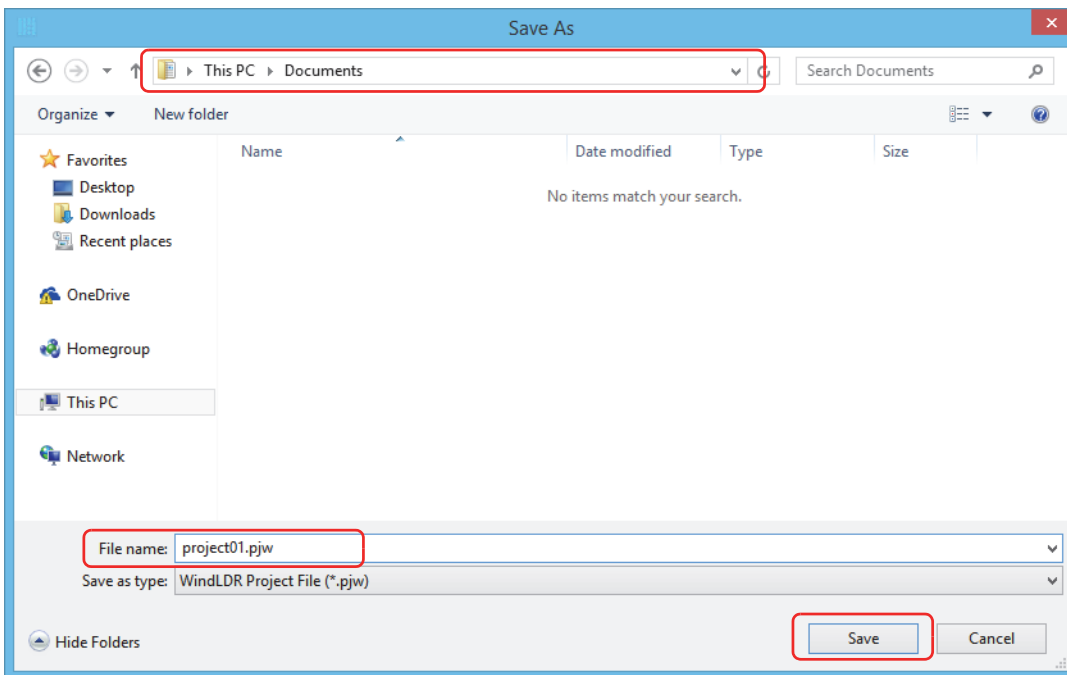

This completes the procedure to save a project to a file.

Note: The saved file is called a project file. The extension is ".pjw".

Simulate Operation

This section describes the operating procedure to check the operation of the user program before transferring it to the FC6A Series MICROSmart.

From the WindLDR menu bar, select **Online > Simulation**. The Simulation screen appears.

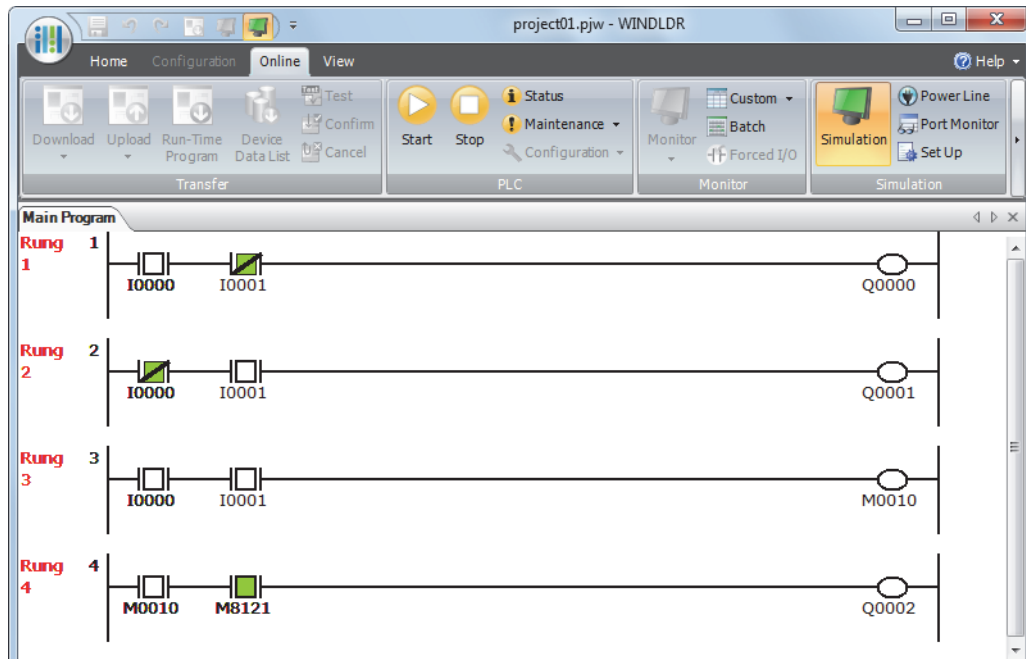

Select and right-click the input contact you want to change, and on the right-click menu, click **Set** or **Reset**.

To quit simulation, from the WindLDR menu bar, select **Online > Simulation**.

Notes:

- You can also change the status of an input contact by double-clicking it.
- To quit simulation, from the WindLDR menu bar, once more select **Online > Simulation > Simulation**.

Download Program

While WindLDR is running on a PLC, you can download the user program to the FC6A Series MICROSmart.

User programs can be downloaded to the FC6A Series MICROSmart from WindLDR using USB or Ethernet.

This section describes the operating procedure from configuring communication settings to downloading the user program using a USB connection as an example.

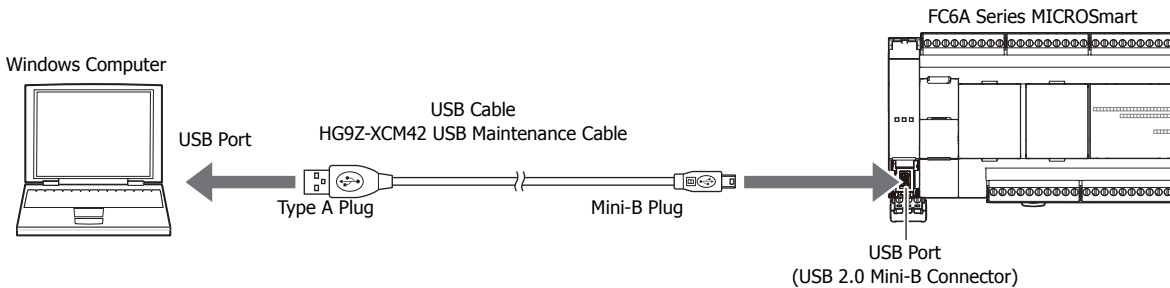

Notes:

- In order for WindLDR to communicate with the FC6A Series MICROSmart via USB, a dedicated USB driver must be installed on the computer. For details, see "How to install USB driver". Click ▼ to the right of the icon (?) at the top right corner of the WindLDR window and click **How to install USB driver** to display **How to install USB driver**.
- A user program is a combination of a ladder program and the setting details (Function Area Settings).

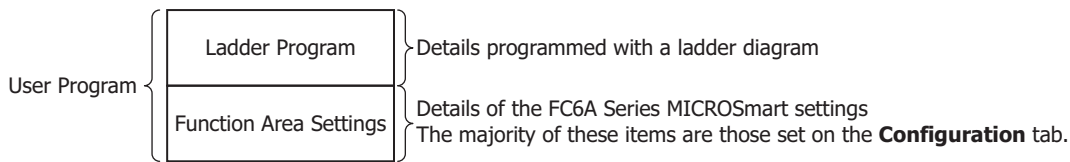

1. From the WindLDR menu bar, select **Online > Set Up**. The **Communication Settings** dialog box is displayed.
2. Click the **USB** tab and then click **OK**.

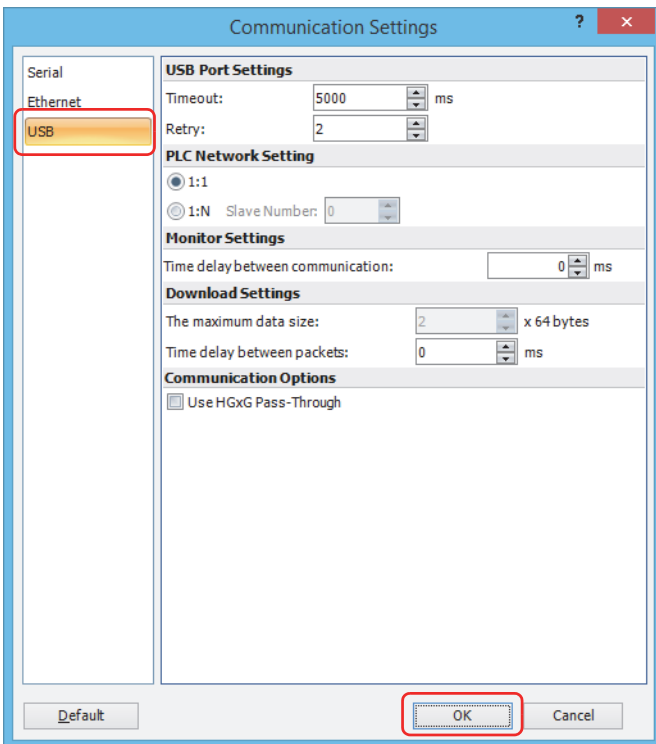

The communication method is now set to USB. Next, download a user program.

3. From the WindLDR menu bar, select **Online > Download**. The **Download** dialog box appears, then click **OK**. The user program is downloaded to the FC6A Series MICROSmart.

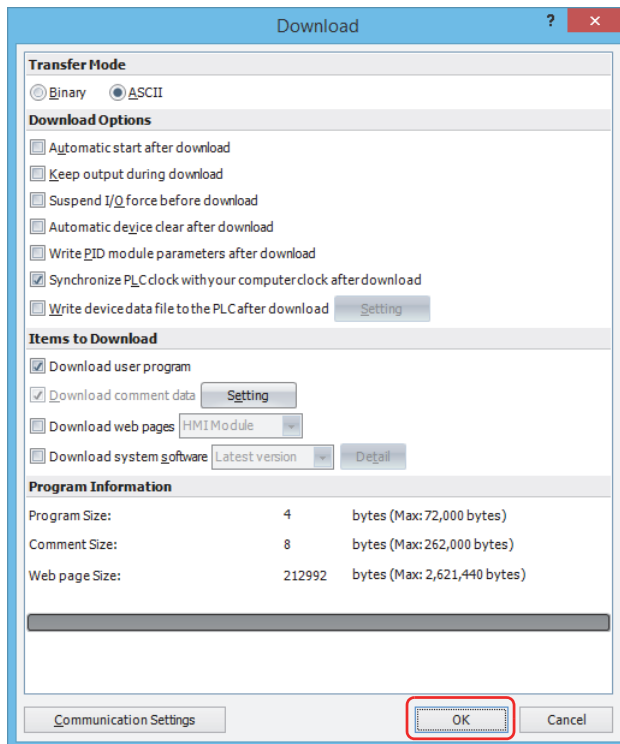

Note: The Download dialog box can also be opened by selecting **Home > Download**.

Note: When downloading a user program, all values and selections in the Function Area Settings are also downloaded to the FC6A Series MICROSmart. For details on function settings, see "Functions and Settings" on page 5-1.

When the following message appears, the download has completed successfully. Click **OK**.

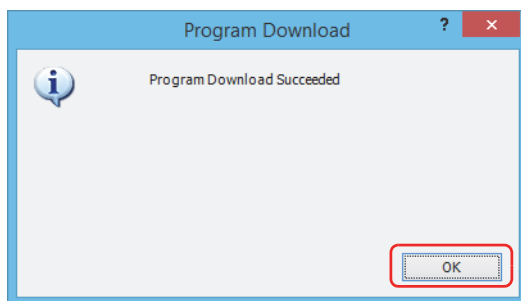

Notes:

- The PLC will not run if the function switch is 0 when **Run/Stop PLC by Function Switch** is enabled in WindLDR and a program is downloaded with **Automatic start after download** enabled. To run the PLC, the function switch must be set to 1.
- Enabled is the default setting for **Run/Stop PLC by Function Switch** in WindLDR.

4: OPERATION BASICS

Monitor Operation

Another powerful function of WindLDR is to monitor the PLC operation on the computer. The input and output statuses of the sample program can be monitored in the ladder diagram.

From the WindLDR menu bar, select **Online > Monitor > Monitor**.

When both inputs I0 and I1 are on, the ladder diagram on the monitor screen looks as follows:

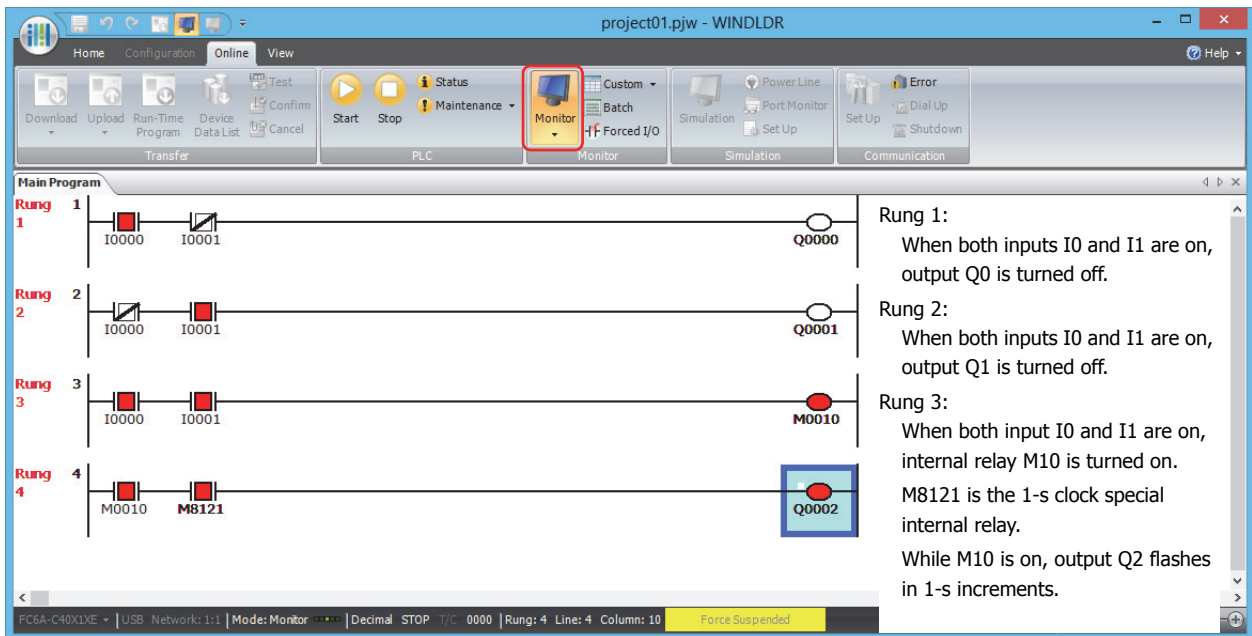

Exit WindLDR

This section describes the operating procedure to exit WindLDR.

When you have completed monitoring, you can exit WindLDR either directly from the monitor screen or from the editing screen. In both cases, from the WindLDR application button, click **Exit WindLDR**.

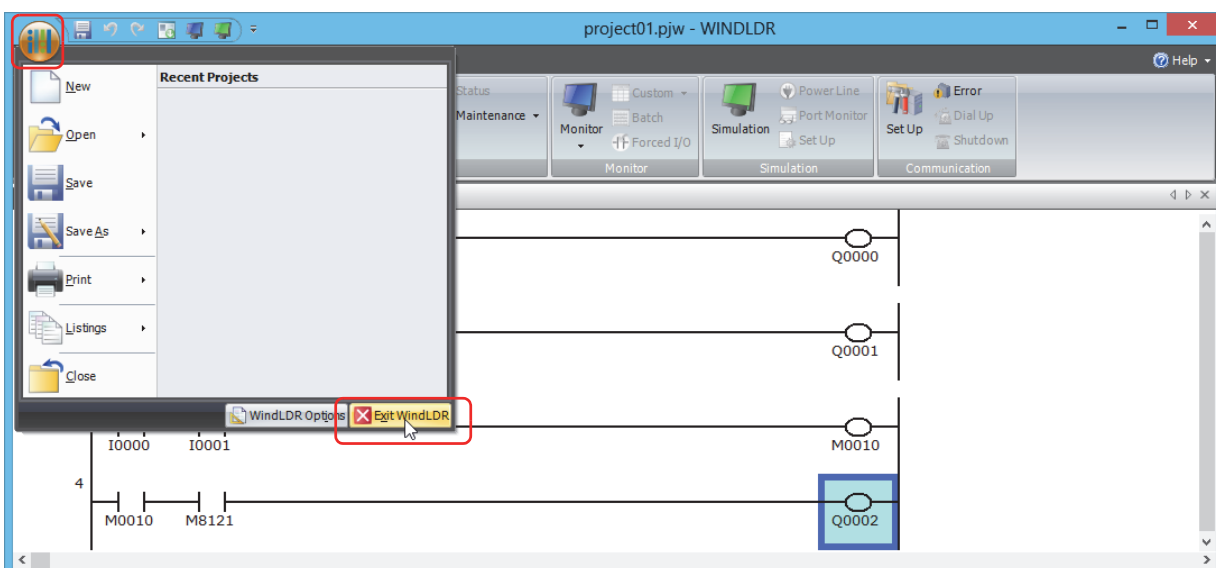

Windows Displayed in the Workspace

This section describes how to change the position and display method of windows.

Changing the position of windows

You can change the display position of the window by dragging and dropping the title bar of the window or its tab to disable docking. Windows that are not docked are called floating windows.

Disabling docking

This section describes how to disable the docking of a title bar or tab of a window.

- If you drag the title bar of the workspace window, you can move all the docked windows together.

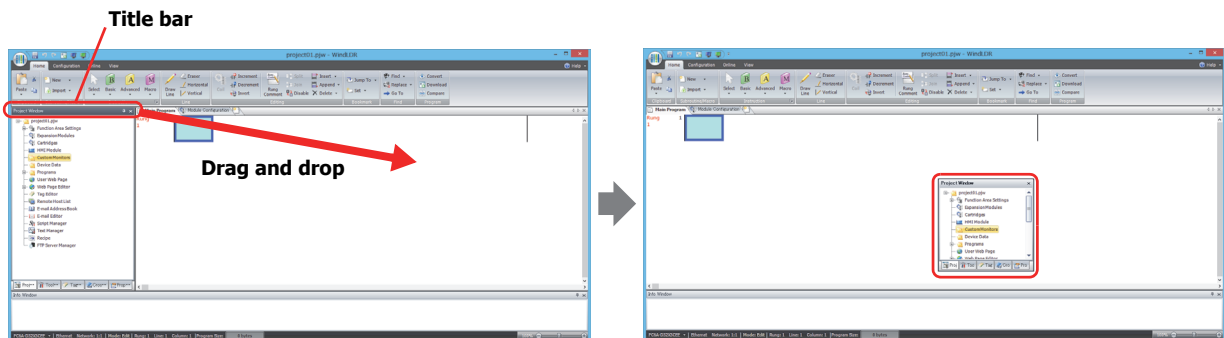

- If you drag the tab of a workspace window, you can move just the selected window.

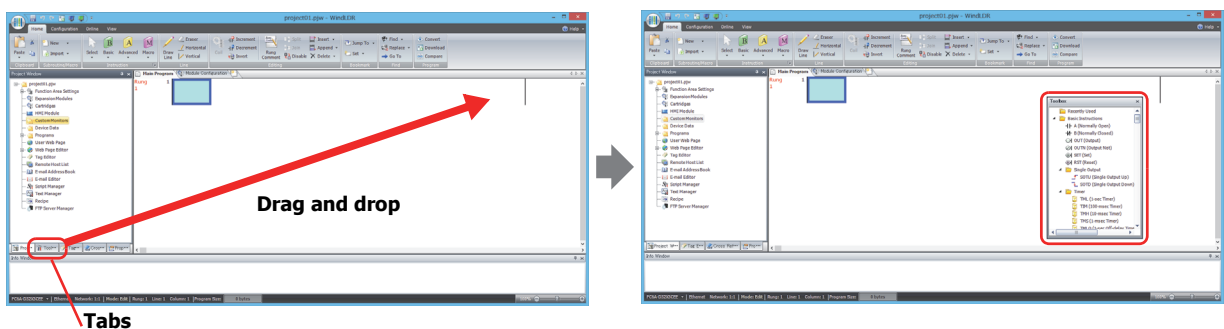

Docking windows

This section describes how to dock a floating window to another window or the frame at the top, bottom, left, and right sides of WindLDR.

1. Drag the window's title bar or tab.
The  (Docking) icon is displayed.

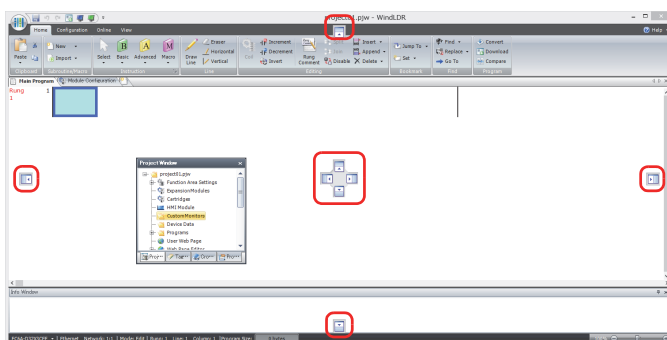

4: OPERATION BASICS

Note: When the mouse cursor gets close to a  (Docking) icon while dragging the title bar or tab, the location to dock the window is displayed.

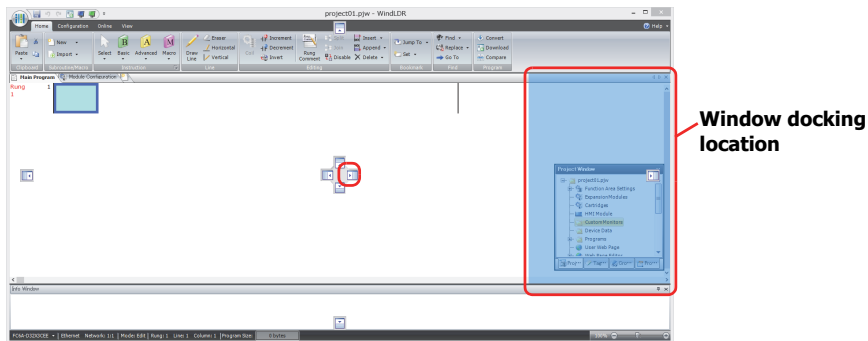

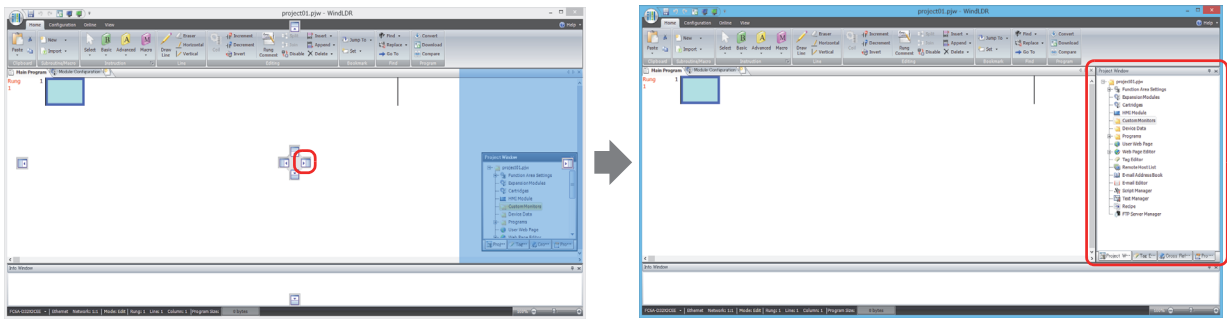

2. Drop the title bar or tab on the  (Docking) icon to dock that window to WindLDR's left, right, top, or bottom frame or a separate window.

- If the workspace window is dropped on the  (Docking) icon, it is docked to WindLDR's left, right, top, or bottom frame.

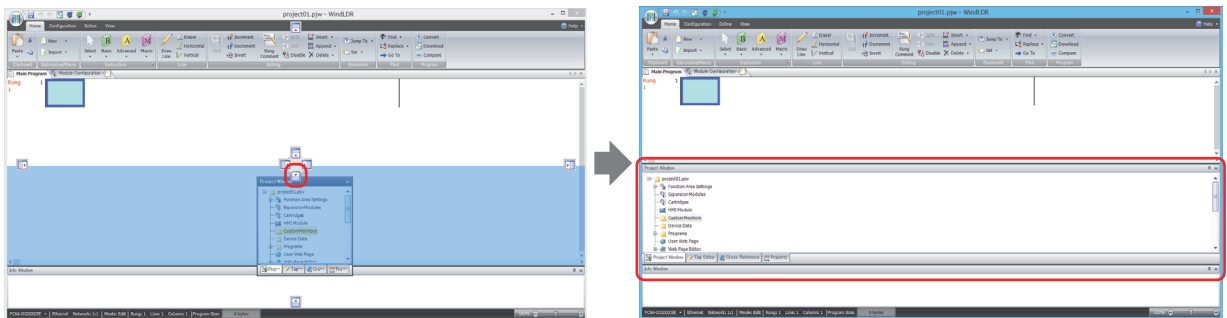

- If a floating window is dropped on the  (Docking) icon, it is docked to WindLDR's left, right, top, or bottom frame or a docked window.



- If you put the mouse cursor on another window while dragging a floating windows title bar, the  (Docking) icon is displayed. Drop the title bar on the  (Docking) icon to dock the floating window to that window. Change the displayed window with the tabs.

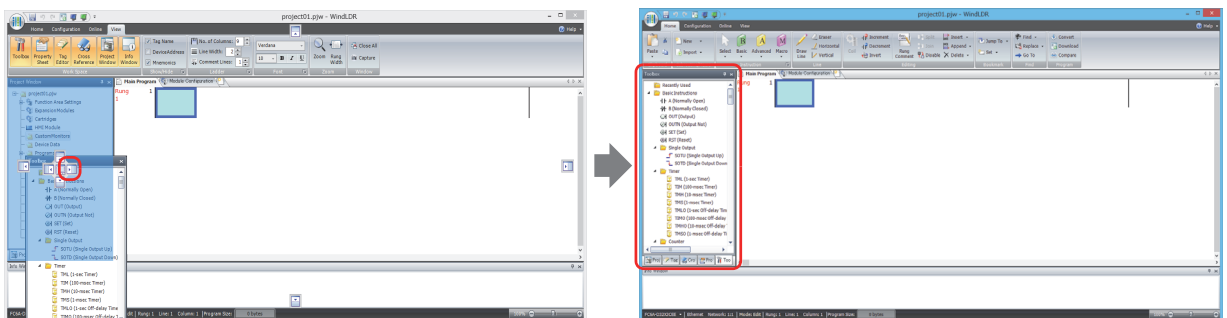

Changing the display method of windows

If the workspace window is docked, you can change the window to automatically hide and show only its tabs.

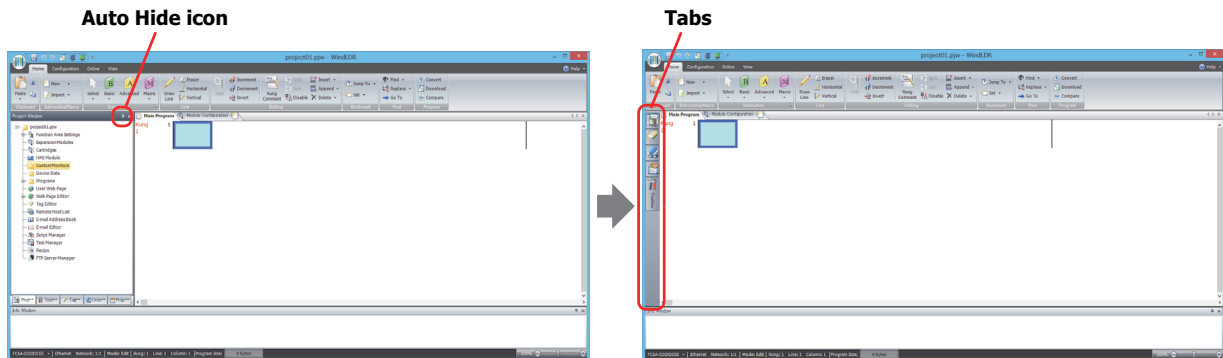

- Click the  (Auto Hide) icon to change the window to show only its tabs.

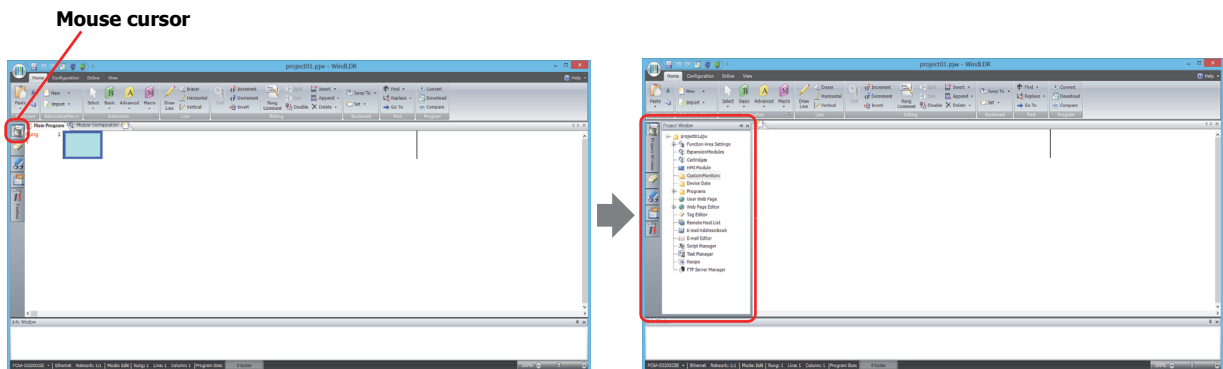

- The window is displayed when you bring the mouse cursor close to the tabs.



Notes:

- Click  (Auto Hide) to secure the window in place.
- Click  (Close) to close the window.

Checking the WindLDR Version Number

This section describes how to check the WindLDR version.

1. Click  (application) button > **WindLDR Options**.

The **WindLDR Options** dialog box appears.

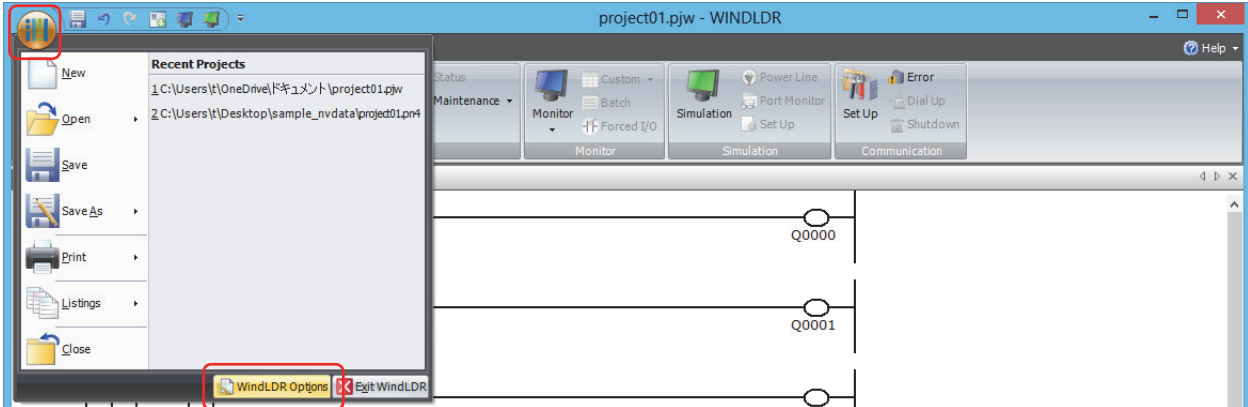

2. Click the **Resources** tab, and then click **About**.

The **About WindLDR** dialog box appears.

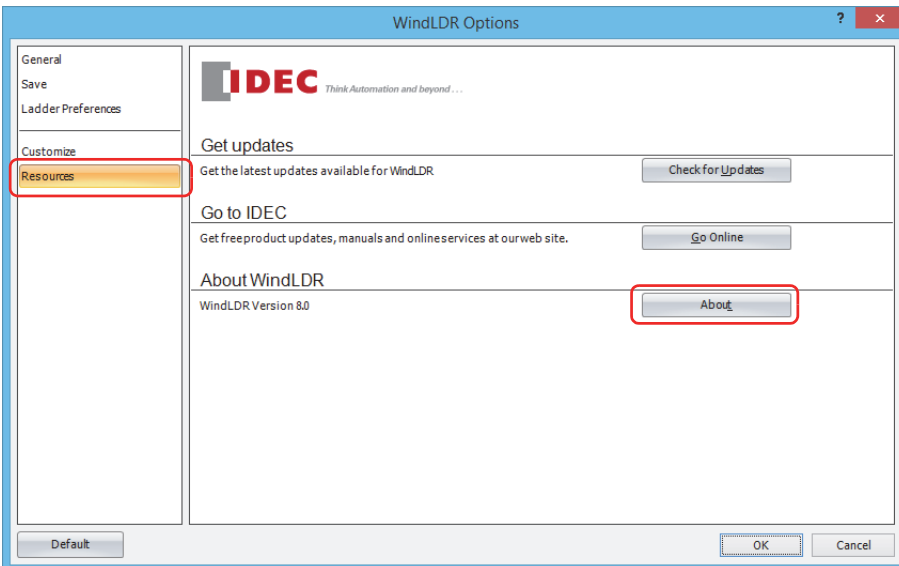

You can check the WindLDR version. When finished, click **OK**.



Note: When using the FC6A Series MICROsmart, use the following versions of WindLDR.

- All-in-One CPU module/CAN J1939 All-in-One CPU module: WindLDR version 8.0.0 or later
- Plus CPU module: WindLDR version 8.6.0 or later

If you are using a version of WindLDR that does not meet this condition, click **Check for Updates** on the **Resources** tab to obtain the latest version of WindLDR.

This concludes the procedure for checking the WindLDR version.

Ladder Program Operation

The FC6A Series MICROSmart performs the following operations to process ladder programs.

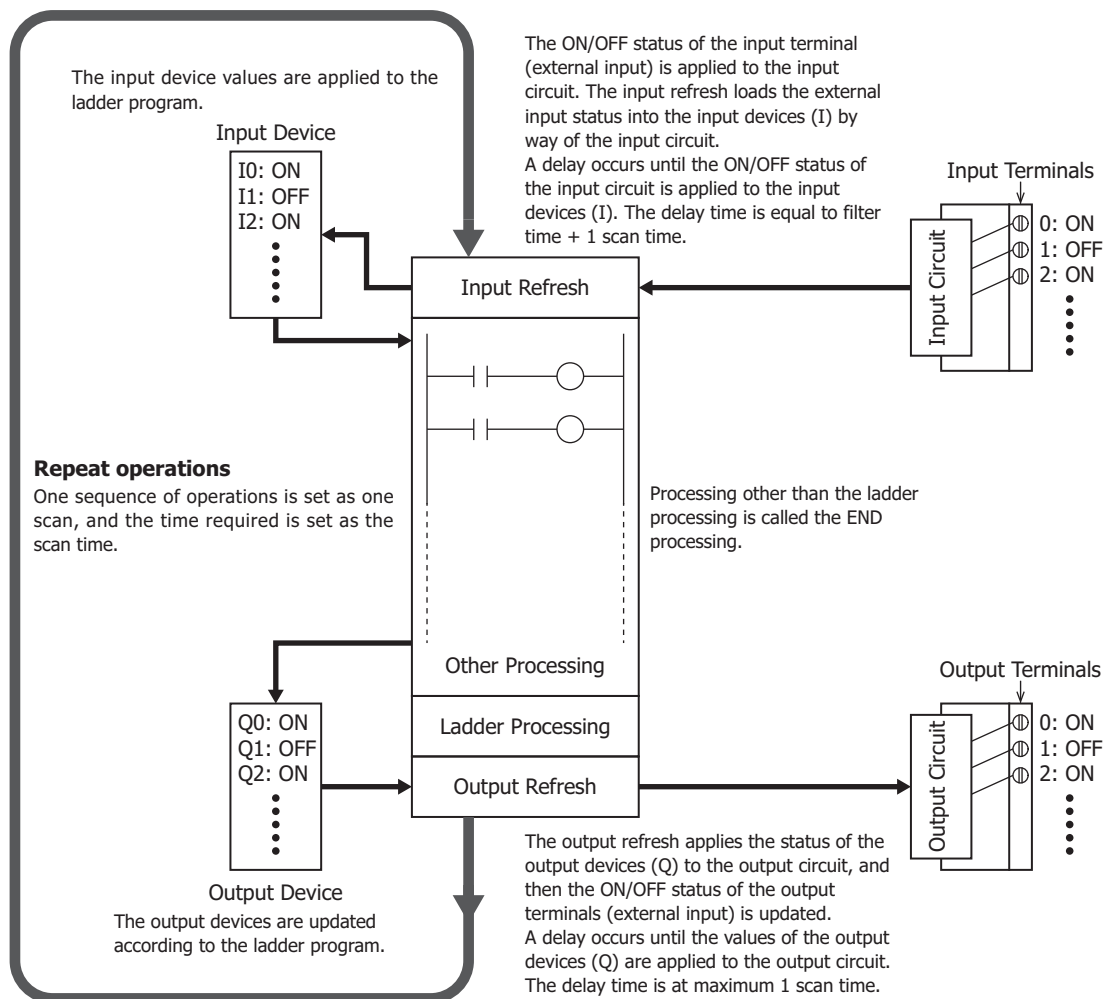

Notes:

- The delay time of the hardware is added to the actual input and output delay times. For details on the hardware input/output delay times, see "Product Specifications" on page 2-1.
- The filter time differs depending on the input used.
 - When the input is a CPU module input (I0 to I27)
See the input filter time configured in the WindLDR **Function Area Settings**. The initial value is 3 ms.
 - When the input is an expansion input (I30 or greater)
There is no filter time.

Start/Stop Operation

This section describes how to run and stop the FC6A Series MICROSmart.



Caution

Make sure of safety before starting and stopping the FC6A Series MICROSmart. Incorrect operation of the FC6A Series MICROSmart may cause machine damage or accidents.

You can start and stop FC6A Series MICROSmart operations by using WindLDR operations, FC6A Series MICROSmart operations, function switch operations, menu operations using an HMI module, by turning the FC6A Series MICROSmart on or off, or by using the stop/reset input function by way of external input.

- For operations using WindLDR, see "Start/Stop Operation Using WindLDR" on page 4-18.
- For operations using the FC6A Series MICROSmart power supply, see "Start/Stop Operation Using the Power Supply" on page 4-19.
- For operations using the function switch, see "Function Switch Configuration" on page 5-11.
- For operations using an HMI module, see "HMI Function" on page 7-1.
- For the stop input settings, see "Stop Input" on page 5-5.
- For the reset input settings, see "Reset Input" on page 5-5.

The switch from start to stop is performed during the END processing of the user program, and the following functions are also stopped when the user program is stopped. For details on END processing, see the appendix "Breakdown of END Processing Time" in the "FC6A Series MICROSmart Ladder Programming Manual".

High-speed counter/frequency measurement/user interrupt/catch input/timer interrupt/user communication/pulse output

- You can use M8025 (Maintain Outputs While Stopped) to select whether to maintain or clear the outputs while the CPU is stopped.
For details on M8025 (Maintain Outputs While Stopped), see "M8025: Maintain Outputs While Stopped" on page 6-10.
- The current value of the timer instruction is reset.
For details on timer instructions, see Chapter 4 "TML (1-s Timer)" in the "FC6A Series MICROSmart Ladder Programming Manual".

Also, when you switch from stop to start, the device status is cleared or kept depending on **Memory Backup** in the **Function Area Settings**. For details, see "Memory Backup" on page 5-13.

Start/Stop Operation Using WindLDR

The FC6A Series MICROSmart can be started and stopped using WindLDR run on a Windows computer connected to the FC6A Series MICROSmart. When the **Start** button is pressed in the menu bar shown below, start control special internal relay M8000 is turned on to start the FC6A Series MICROSmart. When the **Stop** button is pressed, M8000 is turned off to stop the FC6A Series MICROSmart.

1. Connect the computer to the FC6A Series MICROSmart, start WindLDR, and power up the FC6A Series MICROSmart.
2. Check that a stop input is not designated using **Configuration > Run/Stop Control > Stop and Reset Inputs**. See "Stop Input and Reset Input" on page 5-5.

Note: When a stop input is designated, the FC6A Series MICROSmart cannot be started or stopped by turning start control special internal relay M8000 on or off.

3. Select **Online** from the WindLDR menu bar.
The Online tab appears.

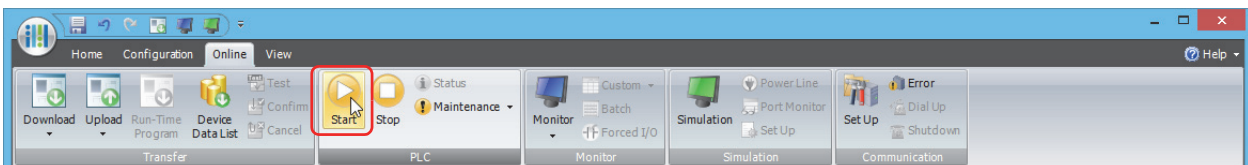

4. Click the **Start** button to start operation, then the start control special internal relay M8000 is turned on.

5. Click the **Stop** button to stop operation, then the start control special internal relay M8000 is turned off.
The PLC operation can also be started and stopped while WindLDR is in the monitor mode. Select **Online > Monitor > Monitor** and click the **Start** or **Stop** button.

Note: Special internal relay M8000 is a keep type internal relay and stores the status when the power is turned off. M8000 retains its previous status when the power is turned on again. However, when the backup battery is dead, M8000 loses the stored status, and can be turned on or off as programmed when the FC6A Series MICROSmart is powered up. The selection is made in **Configuration > Run/Stop Control > Run/Stop Selection at Memory Backup Error**. See "Run/Stop Selection at Keep Data Error" on page 5-9.

Start/Stop Operation Using the Power Supply

The FC6A Series MICROSmart can be started and stopped by turning power on and off.

1. Power up the FC6A Series MICROSmart to start operation.
2. Turn power on and off to start and stop operation.

5: FUNCTIONS AND SETTINGS

Introduction

This chapter describes the FC6A Series MICROSmart's special functions and convenient functions that you should know about in using the WindLDR (Windows compatible) PLC programming software.

Function List

The FC6A Series MICROSmart supports many functions in addition to instructions.

For functions that require advanced setup including the high-speed counters, user program protection functions, and Ethernet communication functions, first configure those settings in the **Function Area Settings** dialog box, and then download the user program to the FC6A Series MICROSmart.

Function Name	Overview	Reference	Setup Location
Stop input	The FC6A Series MICROSmart can be started/stopped with a specified input.	5-7	Function area settings
Reset input	The device values of the FC6A Series MICROSmart can be cleared with a specified input.	5-7	
Run/stop selection at keep data error	This function specifies the user program operating state (run/stop) when the FC6A Series MICROSmart power is turned on when the backup battery has died.	5-9	
Run/stop selection at power up	Whether to start or stop the FC6A Series MICROSmart regardless of the M8000 status when the FC6A Series MICROSmart is powered up can be specified.	5-10	
Function switch configuration	This function configures the operation when the FC6A Series MICROSmart function switch is used.	5-11	
Memory backup	Whether to clear or keep the device values, such as counter current values, when the FC6A Series MICROSmart starts running can be specified.	5-13	
High-speed counter	The high-speed counters can be used to count input pulses from rotary encoders or proximity switches regardless of the scan time.	5-15	
Catch input	The catch input can be used to receive short pulses from sensors regardless of the scan time.	5-35	
Interrupt input	When a quick response to an external input is required, such as in positioning control, the interrupt input can call a subroutine to execute an interrupt program.	5-37	
Frequency measurement	The pulse frequency of input signals to input terminals can be counted regardless of the scan time.	5-40	
Input filter	The input filter rejects short input pulses when the FC6A Series MICROSmart is used with input signals containing noises.	5-42	
Analog voltage input	Analog voltage input, such as input from pressure sensor, can be read and stored in special data register as digital value.	5-44	
Analog potentiometer	This function changes the analog value used in a user program with the FC6A Series MICROSmart's analog potentiometer.	5-46	
Timer interrupt	When executing the same program repeatedly regardless of the scan time is required, the timer interrupt can call a subroutine at specified time interval.	5-48	
Forced I/O function	The inputs or outputs of the FC6A Series MICROSmart can forcibly be turned on or off regardless of the actual inputs and outputs status.	5-50	Monitor
External memory devices	Configure the CSV file format of the log data to save to the SD memory card.	5-54	Function area settings
Log data file size	The maximum file size of the log data that is saved to the SD memory card can be configured.	5-55	
32-bit data storage setting	The order of upper and lower words for 32-bit data can be specified.	5-56	
User program protection	The user program in the FC6A Series MICROSmart can be protected with a password against the user program upload or download.	5-58	
Watchdog timer settings	The watchdog timer monitors the FC6A Series MICROSmart operation and the watchdog time preset value can be changed.	5-60	
Constant scan time	The scan time of the FC6A Series MICROSmart can be made constant by specifying the constant scan time.	5-61	
Daylight savings time	The internal clock of the FC6A Series MICROSmart can automatically be adjusted according to the configured daylight saving time period.	5-62	
Clock function	The FC6A Series MICROSmart can operate according to the current date and time and be used in applications, such as lighting or air conditioning.	5-63	Instructions

5: FUNCTIONS AND SETTINGS

Function Name	Overview	Reference	Setup Location
Battery monitor	This function monitors the voltage of the backup battery.	5-66	—
USB boot	This function starts the FC6A Series MICROSmart with only USB bus power (5 V).	5-68	—
User program capacity	This function selects the FC6A Series MICROSmart user program capacity.	5-70	Function area settings
Online Edit	This function rewrites the user program without stopping FC6A Series MICROSmart operation.	5-71	—
Communication port	Configures the communication methods and ports for the connected devices.	Communication Manual	Function area settings
Network settings	Configures information for connecting the FC6A Series MICROSmart to a network.		
Ethernet Port 1			
Ethernet Port 2			
Network management	Configures SNTP settings and the PING instruction timeout time.		
Connection settings	Communication mode and parameters for the Ethernet communication can be configured for each connection so that the FC6A Series MICROSmart can communicate with other network devices over the Ethernet.		

Function Area Settings

This section describes the function area settings that configure the environment settings for using the FC6A Series MICROSmart, such as the operation when starting the FC6A Series MICROSmart and the communication ports.

The function area settings are configured on the **Function Area Settings** dialog box in the WindLDR PLC programming software (Windows compatible).

Displaying the Dialog Box

To display the **Function Area Settings** dialog box, on the **Configuration** tab, in the **Function Area Settings** group, click a configuration item.

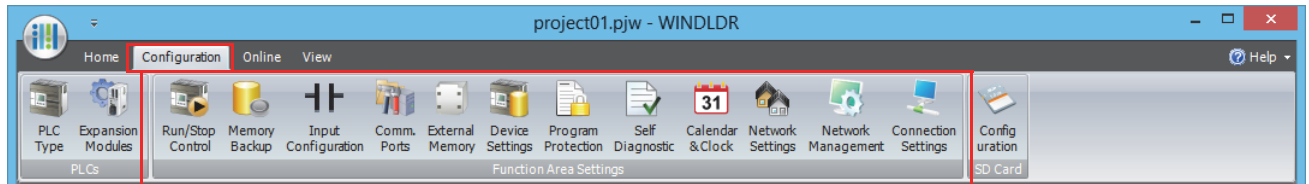

The **Function Area Settings** dialog box is displayed with the selected configuration item.

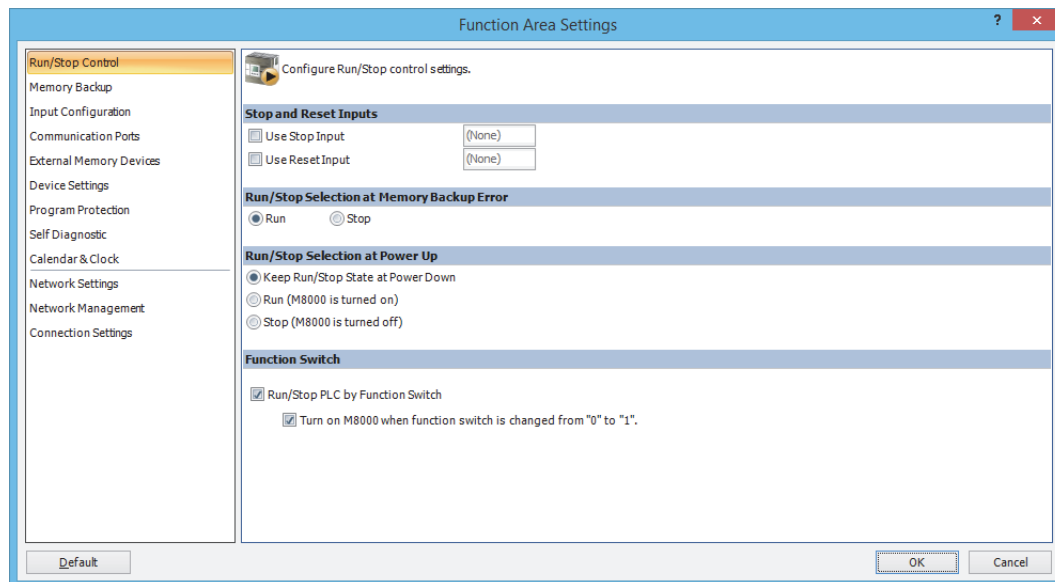

Configuration Items and Functions

The function area settings configuration items and functions are as follows.

- | | |
|------------------|--|
| Run/Stop Control | <p>Configure the following run/stop control settings.</p> <ul style="list-style-type: none"> • Stop input • Reset input • Run/stop selection at memory backup error • Run/stop selection at power up • Function switch configuration |
| Memory Backup | <p>These functions keep or clear devices (the contents of memory) when a user program starts operation (RUN).</p> <p>The following devices can be configured to be kept or cleared.</p> <ul style="list-style-type: none"> • Internal relays • Shift registers • Counters • Data registers |

5: FUNCTIONS AND SETTINGS

Input Configuration	<p>These settings configure special input functions such as the external input filter values and high-speed counters.</p> <ul style="list-style-type: none">• High-speed counter• Catch input• Interrupt input• Frequency measurement• Input filter• Analog voltage input• Analog input• Timer interrupt
Communication Ports	<p>These settings configure the FC6A Series MICROSmart communication ports that communicate with external devices.</p> <ul style="list-style-type: none">• Maintenance communication• User communication• Modbus RTU master/slave• Data link master/slave station• J1939 (CAN J1939 All-in-One CPU module only)
External Memory Devices	<p>These settings configure the CSV file format and the maximum file size of the log data that is saved to the SD memory card.</p> <ul style="list-style-type: none">• CSV file format• Data log and trace*1
Device Settings	<p>Configure the order to store the upper and lower words for 32-bit data.</p>
Program Protection	<p>Applies the protection to the user program by configuring a password so unauthorized users cannot inadvertently upload or download it.</p>
Self Diagnostic Calendar & Clock	<p>Configure the watchdog timer monitoring the operating status of the FC6A Series MICROSmart.</p> <p>The FC6A Series MICROSmart is equipped with an internal clock and its calendar data (year, month, day, day of the week) and clock data (hour, minute, second) can be used in user programs. Daylight savings time can also be configured for the internal clock.</p>
Network Settings*2	<p>These settings configure information for connecting the All-in-One CPU module to a network using Ethernet port 1.</p>
Network Management*2	<p>These settings configure the FC6A Series MICROSmart's internal clock and the ping timeout time for the PING instruction and when the auto ping function is being executed.</p> <ul style="list-style-type: none">• SNTP settings• Ping settings
Ethernet Port 1*1	<p>These settings configure information for connecting the Plus CPU module to a network using Ethernet port 1. These settings are also used to configure SNTP settings for getting the time, the ping timeout duration when using the PING instruction or auto ping, the send e-mail settings, web server settings, and FTP client/server settings.</p> <ul style="list-style-type: none">• IP settings• DNS settings• SNTP settings• Ping settings• E-mail settings• Web server settings• FTP client settings• FTP server settings
Ethernet Port 2*1	<p>These settings configure information for connecting the Plus CPU module to a network using Ethernet port 2. These settings are also used to configure the ping timeout duration when using the PING instruction or auto ping.</p> <ul style="list-style-type: none">• IP settings• DNS settings• Ping settings
Connection Settings	<p>These settings configure server/client communication used in FC6A Series MICROSmart Ethernet communication.</p> <ul style="list-style-type: none">• Maintenance communication server• User communication server/client• User communication (UDP)*1• Modbus TCP communication server/client

*1 Can be used only with the Plus CPU module.

*2 Can be used only with the All-in-One CPU module.

Stop Input and Reset Input

As described on "Start/Stop Operation" on page 4-18, the FC6A Series MICROSmart can be started and stopped using a stop input or reset input, which can be designated from the **Function Area Settings** menu. When the designated stop or reset input is turned on, the FC6A Series MICROSmart stops operation.

Since these settings relate to the user program, the user program must be downloaded to the FC6A Series MICROSmart after changing any of these settings.

Stop Input

This section describes the stop input that stops execution of the FC6A Series MICROSmart user program with an external input.

Function Description

This function stops execution of the FC6A Series MICROSmart user program with an external input, such as a switch on a control panel. Specify an FC6A Series MICROSmart normal external input for the stop input.

When the stop input is turned on, the user program that is being executed will stop. When the stop input is turned off, the user program will be executed from the beginning.

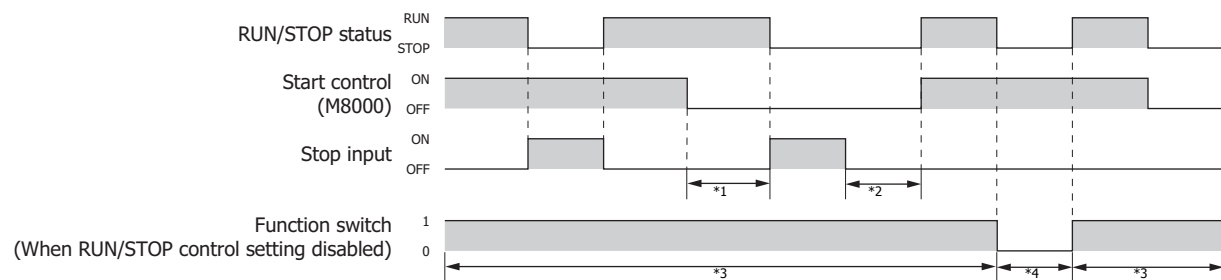

*1 Even when M8000 (start control) is turned off, if the stop input is off, the FC6A Series MICROSmart maintains the RUN status.

*2 Even when the stop input is off, M8000 (start control) is off, so the FC6A Series MICROSmart does not change to the RUN status.

*3 When the function switch is set to the function to control FC6A Series MICROSmart RUN/STOP, the status changes to that corresponding to the stop input and M8000 when the function switch is 1.

*4 When the function switch is set to the function to control FC6A Series MICROSmart RUN/STOP, the status will not change to the RUN status if M8000 is turned on when the function switch is 0.

The external inputs that can be specified as the stop input are as follows.

All-in-One CPU module

Type	16-I/O type	24-I/O type	40-I/O type
External Input	I0 to I7, I10	I0 to I7, I10 to I15	I0 to I7, I10 to I17, I20 to I27

Plus CPU module

Type	Plus 16-I/O type	Plus 32-I/O type
External Input	I0 to I7	I0 to I7, I10 to I17

Notes:

- The stop input operation has priority over the WindLDR RUN/STOP operation (M8000 ON/OFF).
- In addition to the FC6A Series MICROSmart stopping the user program with an external input, RUN/STOP operations can also be performed by operating the function switch and by changing the start control (M8000) value with WindLDR.
- While the reset input is on, user program execution stops. For details on the reset input, see "Reset Input" on page 5-5.

Reset Input

This section describes the reset input that clears FC6A Series MICROSmart device values with an external input.

Function Description

This function clears FC6A Series MICROSmart device values with an external input, such as a switch on a control panel. Specify an FC6A Series MICROSmart normal external input for the reset input.

When the reset input is turned on, the user program that is being executed will stop, and all devices and general errors will be cleared except the special internal relays and special data registers. When the reset input is turned off, the user program will be executed from the beginning.

To turn off the reset input and execute the user program again, the following conditions must be met.

- M8000 is on
- The stop input is off (when the stop input has been configured)
- The function switch is 1 (when the function to control FC6A Series MICROSmart RUN/STOP has been configured)

If these conditions are not met, the user program will not be executed and the FC6A Series MICROSmart will remain stopped even if the reset input is turned off.

The external inputs that can be specified as the reset input are as follows.

5: FUNCTIONS AND SETTINGS

All-in-One CPU module

Type	16-I/O type	24-I/O type	40-I/O type
External Input	I0 to I7, I10	I0 to I7, I10 to I15	I0 to I7, I10 to I17, I20 to I27

Plus CPU module

Type	Plus 16-I/O type	Plus 32-I/O type
External Input	I0 to I7	I0 to I7, I10 to I17

Programming WindLDR

1. From the WindLDR menu bar, select **Configuration > Run/Stop Control**.
The **Function Area Settings** dialog box for Run/Stop Control appears.

2. Click the check box under the Stop and Reset Inputs.

Stop Input: Click the check box on the left of Use Stop Input and type a desired input number available on the FC6A Series MICROSmart in the Stop Input field.

Reset Input: Click the check box on the left of Use Reset Input and type a desired reset number available on the FC6A Series MICROSmart in the Reset Input field.

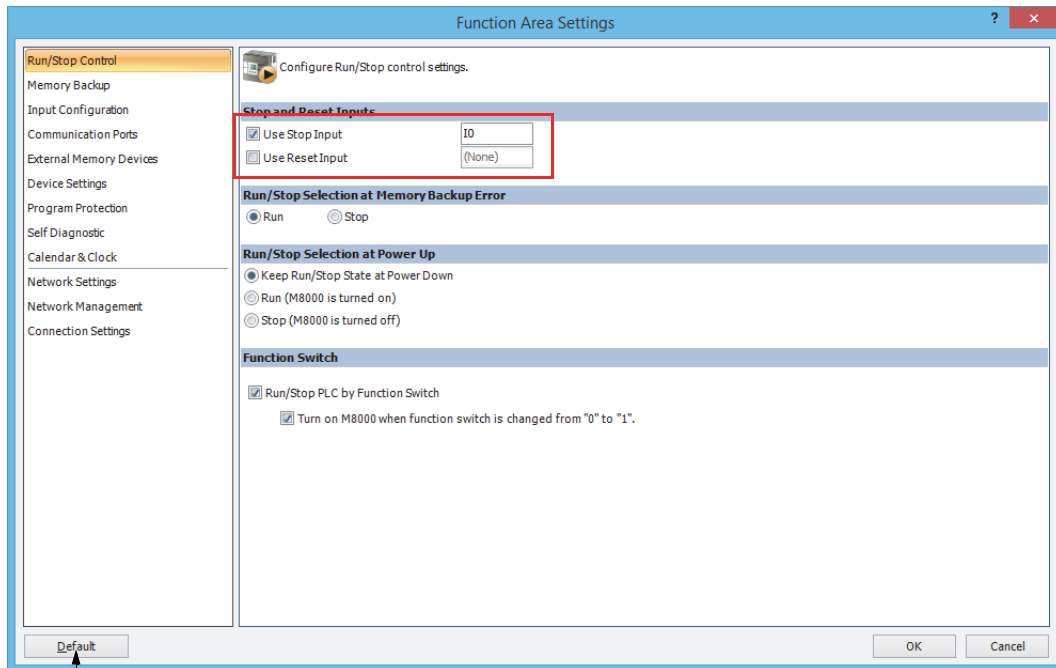

Resets all Function Area Settings values to defaults.

Default: No stop and reset inputs are designated.

3. Click **OK**.

This concludes configuring the settings.

After you download the user program, you can stop it by turning on I0.

5: FUNCTIONS AND SETTINGS

When I1 is specified as the reset input and I1 is turned on, the user program is stopped and device values are cleared. Device values of FC6A Series MICROSmart at each status is as follows:

		During Run	Stopped	Stop to Run	During Reset	Power Off
Outputs		Program operation	OFF	Maintained	OFF	OFF
Internal Relays, Shift Registers, Counters, Data Registers	Range Specified as "Keep"*1	Program operation	Maintained	Maintained	Cleared	Maintained
	Range Specified as "Clear"*1	Program operation	Maintained	Cleared	Cleared	Maintained
Special Internal Relays		Program operation	*2	Maintained	Maintained	*2
Special Data Registers		Program operation	Maintained	Maintained	Maintained	Maintained
Non-retentive Data Registers		Program operation	Maintained	Maintained	Cleared	Cleared
Timer Current Values		Program operation	Maintained	Initialized	Cleared	Cleared

*1 Keep and clear designations for internal relays, shift registers, counters, and data registers can be configured in the **Function Area Settings** dialog box in WindLDR. For details, see "Memory Backup" on page 5-13.

*2 See "Special Internal Relay" on page 6-4.

Run/Stop Selection at Keep Data Error

This section describes the function for specifying the run/stop status of the user program when the FC6A Series MICROSmart "keep" data is lost.

The keep data (data that is maintained by the FC6A Series MICROSmart), such as the device values and the current time, is lost when the FC6A Series MICROSmart power is turned off and left this way for a long time such that the backup battery dies. When the FC6A Series MICROSmart has lost its keep data and is turned on, a keep data error occurs. You can specify the run/stop status of the user program when this keep data error occurs.

Specify **Stop** when unexpected operation may result due to running the FC6A Series MICROSmart when the keep data has been lost. Specify **Run** when you want to run the FC6A Series MICROSmart at all times regardless of whether a keep data error has occurred.

Notes:

- The FC6A Series MICROSmart uses the backup battery to maintain the run/stop status (status of M8000) immediately before the power is turned off. When the power is turned on, operation starts according to the maintained run/stop status.
- If you turn on the FC6A Series MICROSmart with its maintained data deleted, a keep data error will occur and the value of the special internal relay M8000 (start control) will be lost.
- If a keep data error occurs, the data kept by the FC6A Series MICROSmart will be lost.
- If you specify **Stop** for **Run/Stop Selection at Keep Data Error**, the FC6A Series MICROSmart will stop if a keep data error occurs. To run the FC6A Series MICROSmart, perform the appropriate operations from WindLDR, an HMI module, or the main unit's function switch. For details, see "Start/Stop Operation" on page 4-18.
- When a keep data error occurs, the error code is written to special data register D8005 (general error code). For details, see "General Error Codes" on page 13-3.

Programming WindLDR

1. From the WindLDR menu bar, select **Configuration > Run/Stop Control**.
The **Function Area Settings** dialog box is displayed.
2. Click **RUN** or **STOP** under **Run/Stop Selection at Keep Data Error**.

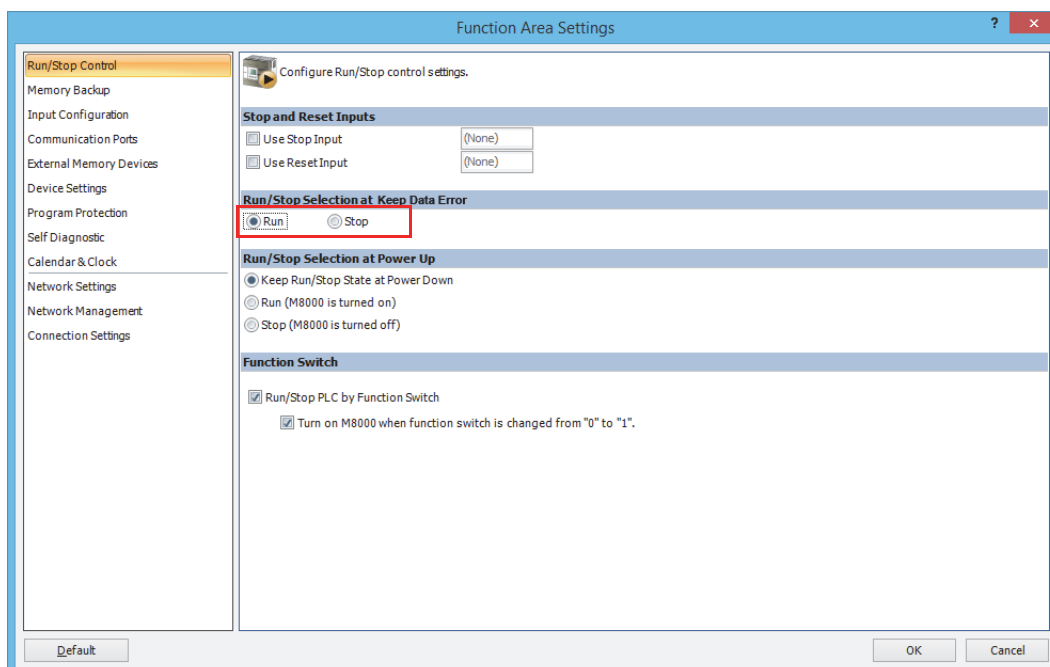

3. Click **OK**.

This concludes configuring the settings.

Run/Stop Selection at Power Up

Start control special internal relay M8000 maintains its status when the FC6A Series MICROSmart is powered down. When powered up, the FC6A Series MICROSmart is started or stopped according to the M8000 status. The Run/Stop Selection at Power Up is used to select whether to start or stop the FC6A Series MICROSmart regardless of the M8000 status when the FC6A Series MICROSmart is powered up.

Stop and reset inputs and function switch have priority over **Run/Stop Selection at Power Up**. When the memory backup error occurs, the FC6A Series MICROSmart is started or stopped according to Run/Stop Selection at Memory Backup Error regardless of Run/Stop Selection at Power Up. For start/stop operation, see "Start/Stop Operation" on page 4-18.

Since this settings relate to the user program, the user program must be downloaded to the FC6A Series MICROSmart after changing this settings.

Programming WindLDR

1. From the WindLDR menu bar, select **Configuration > Run/Stop Control**.

The **Function Area Settings** dialog box for Run/Stop Control appears.

2. Click the button under Run/Stop Selection at Power Up.

Keep Run/Stop State at Power Down (Default):

Click this button to keep the run/stop status at power down when the FC6A Series MICROSmart is powered up.

Run (M8000 is turned on):

Click this button to always start the FC6A Series MICROSmart when the FC6A Series MICROSmart is powered up. However, when the function to control running and stopping the FC6A Series MICROSmart is set for the function switch, the function switch must be set to 1.

Stop (M8000 is turned off):

Click this button to always stop the FC6A Series MICROSmart when the FC6A Series MICROSmart is powered up.

This example designates Keep Run/Stop Status at Power Down.

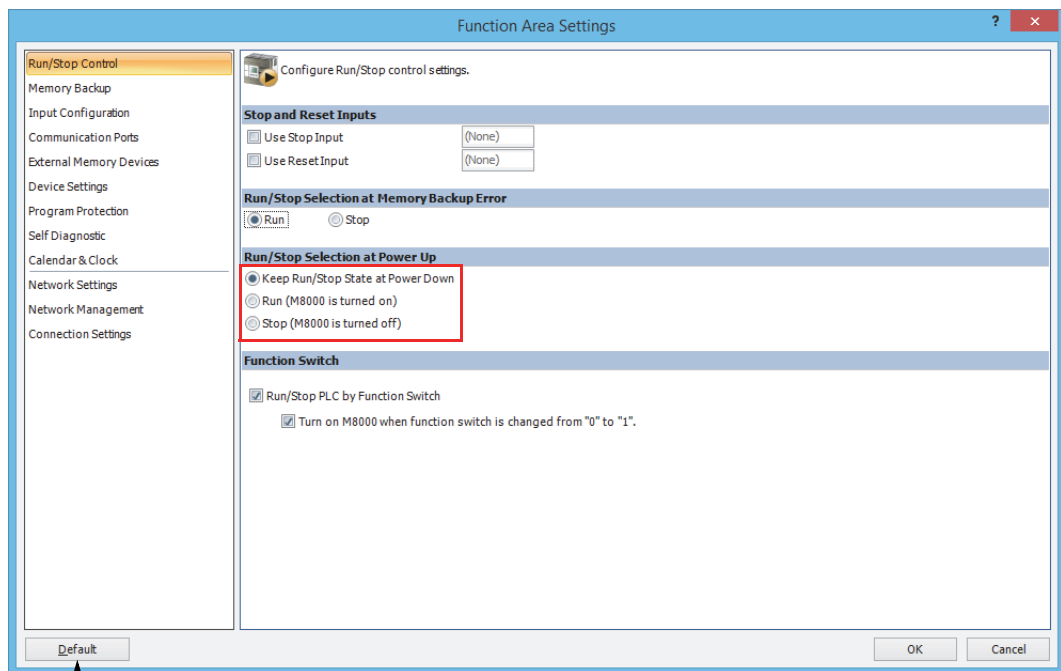

Resets all Function Area Settings values to defaults.

3. Click **OK**.

This concludes configuring the settings.

Function Switch Configuration

This section describes the function of the function switch on the front of the FC6A Series MICROSmart.

Function Description

When Function switch is 0, special internal relay M8073 (Function switch status) turns off. When Function switch is 1, M8073 turns on. The function switch can be used as an external switch by using M8073.

When special internal relay M8000 (start control) is on, running and stopping the FC6A Series MICROSmart can be controlled with the function switch.

Notes:

- Stop input and reset input have priority over the status of M8000.
- Enabled is the default setting for **Run/Stop PLC by Function Switch** and **Turn on M8000 when function switch is changed from "0" to "1"**. in WindLDR.

When **RUN/STOP PLC by Function Switch** is disabled

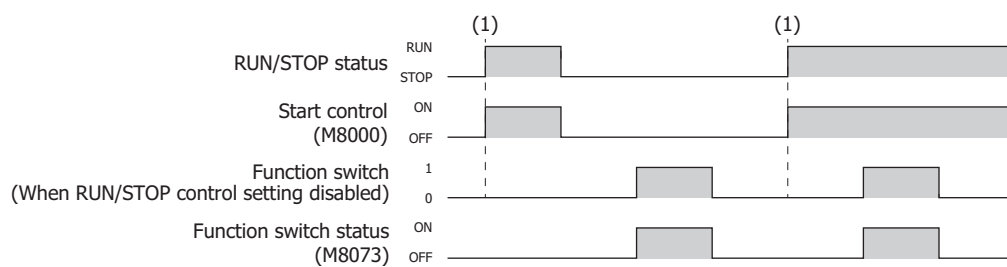

(1) The FC6A Series MICROSmart run/stop status is controlled by the status of M8000, regardless of the function switch.

* M8073 turns on and off according to the status of the function switch.

When **RUN/STOP PLC by Function Switch** is enabled and **Turn on M8000 when function switch is changed from "0" to "1"** is disabled

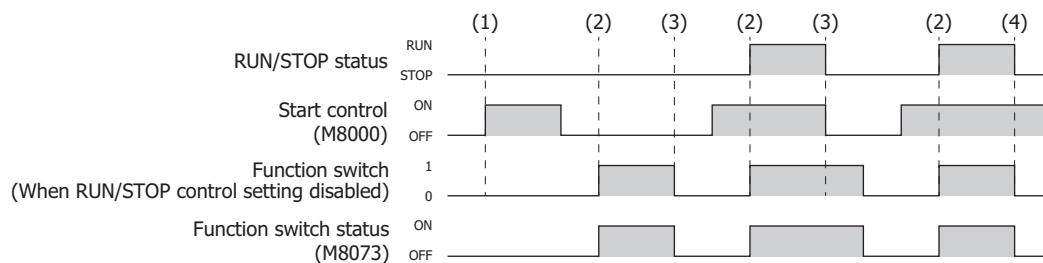

(1) When the function switch is 0, the FC6A Series MICROSmart remains in the stopped state, even when M8000 is turned on.

(2) When the function switch is changed from 0 to 1, the FC6A Series MICROSmart runs or stops according to the status of M8000.

(3) When the function switch is 1, the FC6A Series MICROSmart stops when M8000 is turned off.

(4) When the function switch is changed from 1 to 0, the FC6A Series MICROSmart stops.

* M8073 turns on and off according to the status of the function switch.

5: FUNCTIONS AND SETTINGS

When **Run/Stop PLC by Function Switch** and **Turn on M8000 when function switch is changed from "0" to "1"**. are enabled (For the default setting)

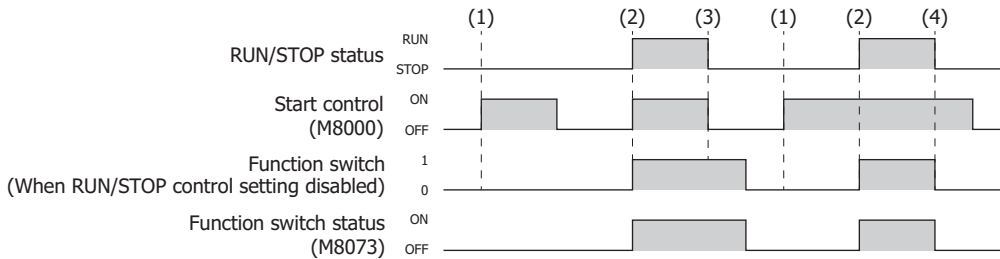

- (1) When the function switch is 0, the FC6A Series MICROSmart remains in the stopped state, even when M8000 is turned on.
 - (2) When the function switch is changed from 0 to 1, and when M8000 is off, it is turned on (remains on when on) and the FC6A Series MICROSmart runs.
 - (3) When the function switch is 1, the FC6A Series MICROSmart stops when M8000 is turned off.
 - (4) When the function switch is changed from 1 to 0, the FC6A Series MICROSmart stops.
- * M8073 turns on and off according to the status of the function switch.

WindLDR Settings

When assigning the function to control FC6A Series MICROSmart running and stopping to the function switch, you must configure **Run/Stop Control** under **Function Switch** in the WindLDR **Function Area Settings**.

• Operation procedure

1. From the WindLDR menu bar, select **Configuration > Run/Stop Control**.
The **Function Area Settings** dialog box is displayed.
2. Select the **Run/Stop PLC by Function Switch** check box.
Select the **Turn on M8000 when function switch is changed from "0" to "1"**. check box.

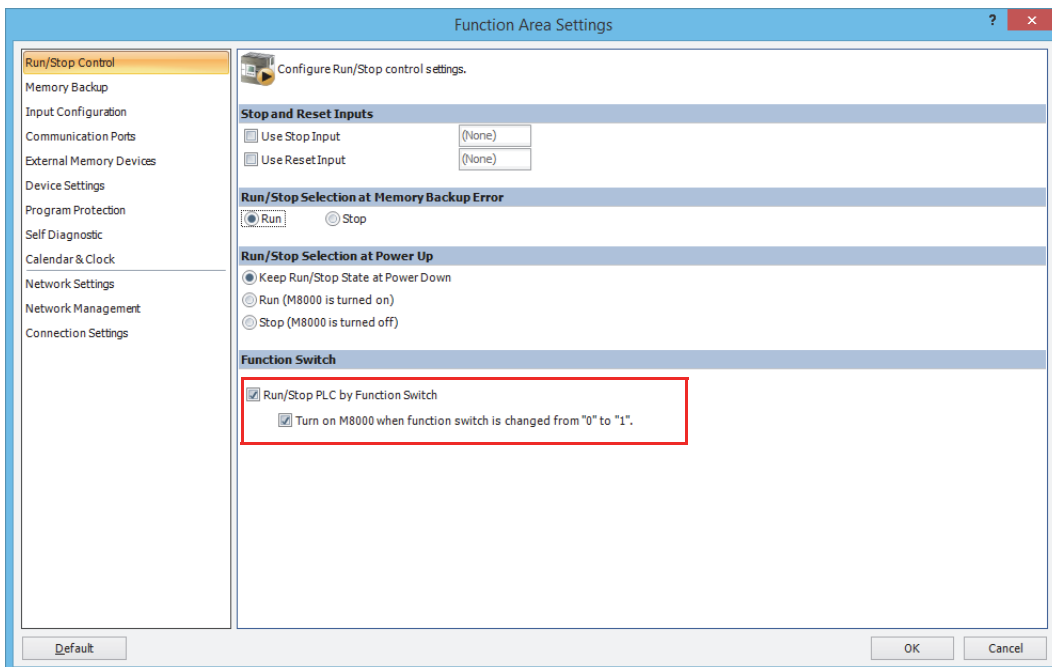

3. Click **OK**.

This concludes configuring the settings.

Memory Backup

The statuses of internal relays and shift register bits are usually cleared at startup. It is also possible to designate all or a block of consecutive internal relays or shift register bits as “keep” types. Counter current values and data register values are usually maintained at powerup. It is also possible to designate all or a block of consecutive counters and data registers as “clear” types. When the FC6A Series MICROSmart is stopped, these statuses and values are maintained. When the FC6A Series MICROSmart is reset by turning on a designated reset input, these statuses and values are cleared despite the settings in the Configure Keep/Clear Settings dialog box shown below. The keep/clear settings in this dialog box are not maintained when restarting the FC6A Series MICROSmart.

Since these settings relate to the user program, the user program must be downloaded to the FC6A Series MICROSmart after changing any of these settings. Device addresses that can be kept or cleared are as follows.

Setting	Device	Internal Relay	Shift Register	Counter	Data Register
		Specify device address to keep		Specify device address to clear	
Type	All-in-One CPU module	M0000-M7997, M10000-M17497	R000-R255	C000-C511	D0000-D7999, D10000-D55999
	CAN J1939 All-in-One CPU module				
	Plus CPU module	M0000 to M7997, M10000 to M21247	R000 to R255	C000 to C511	D0000 to D7999, D10000 to D61999*1

*1 Memory backup for the non-retentive data registers (D70000 to D269999) is not supported.

Programming WindLDR

- From the WindLDR menu bar, select **Configuration > Memory Backup**. The **Function Area Settings** dialog box for Configure Keep/Clear Settings appears.
- Click the buttons under Internal Relay, Shift Register, Counter, and Data Register to clear all, keep all, or keep/clear specified range as required.

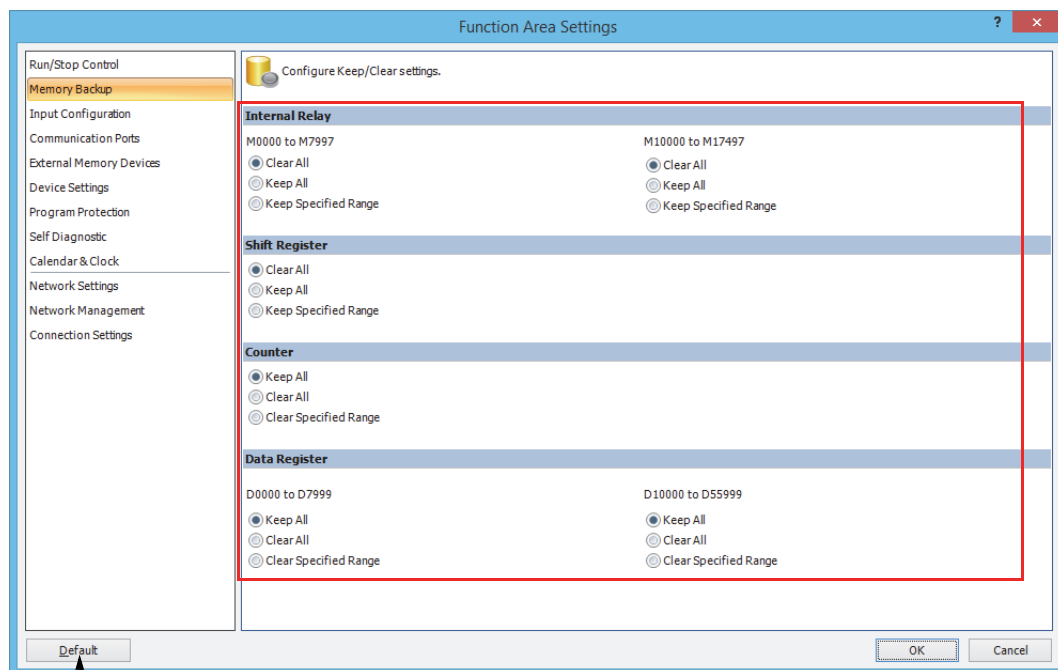

Resets all Function Area Settings values to defaults.

- Click **OK**.

This concludes configuring the settings.

Internal Relay 'Keep' Designation (M0000 to M7997)

- Clear All:** Clears the internal relays (M0000 to M7997) when the FC6A Series MICROSmart starts operation.
- Keep All:** Keeps the status of the internal relays (M0000 to M7997) while the FC6A Series MICROSmart power is off.
- Keep Specified Range:** Keeps the status of the internal relays in the specified range while the FC6A Series MICROSmart power is off.

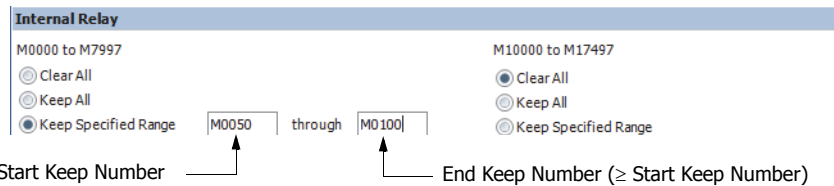

When a range of M50 through M100 is designated as shown in the example above, M50 through M100 are keep types, M0 through M47 and M101 through M7997 are clear types.

Internal Relay 'Keep' Designation (All-in-One CPU module: M10000 to M17497, Plus CPU module: M10000 to M21247)

- Clear All:** Clears the internal relays (All-in-One CPU module: M10000 to M17497, Plus CPU module: M10000 to M21247) when the FC6A Series MICROSmart starts operation.
- Keep All:** Keeps the status of the internal relays (All-in-One CPU module: M10000 to M17497, Plus CPU module: M10000 to M21247) while the FC6A Series MICROSmart power is off.
- Keep Specified Range:** Keeps the status of the internal relays in the specified range while the FC6A Series MICROSmart power is off.

Shift Register 'Keep' Designation

- Clear All:** All shift register bit statuses are cleared at startup (default).
- Keep All:** All shift register bit statuses are maintained at startup.
- Keep Specified Range:** A specified range of shift register bits are maintained at startup. Enter the start "keep" number in the left field and the end "keep" number in the right field. The start "keep" number must be smaller than or equal to the end "keep" number.

Counter 'Clear' Designation

- Clear All:** All counter current values are cleared at startup.
- Keep All:** Keeps all counter current values while the FC6A Series MICROSmart power is off.
- Clear Specified Range:** A specified range of counter current values are cleared at startup. Enter the start "clear" number in the left field and the end "clear" number in the right field. The start "clear" number must be smaller than or equal to the end "clear" number.

Data Register 'Clear' Designation (D0000 to D7999)

- Clear All:** Clears the values of the data registers (D0000 to D7999) when the FC6A Series MICROSmart starts operation.
- Keep All:** Keeps the values of the data registers (D0000 to D7999) while the FC6A Series MICROSmart power is off.
- Clear Specified Range:** A specified range of data register values are cleared at startup. Enter the start "clear" number in the left field and the end "clear" number in the right field. The start "clear" number must be smaller than or equal to the end "clear" number.

Data Register 'Clear' Designation (All-in-One CPU module: D10000 to D55999, Plus CPU module: D10000 to D61999)

- Clear All:** Clears the values of the data registers (All-in-One CPU module: D10000 to D55999, Plus CPU module: D10000 to D61999) when the FC6A Series MICROSmart starts operation.
- Keep All:** Keeps the values of the data registers (All-in-One CPU module: D10000 to D55999, Plus CPU module: D10000 to D61999) while the FC6A Series MICROSmart power is off.
- Clear Specified Range:** A specified range of data register values are cleared at startup. Enter the start "clear" number in the left field and the end "clear" number in the right field. The start "clear" number must be smaller than or equal to the end "clear" number.

Notes:

- When the FC6A Series MICROSmart has lost its keep data, the **Run/Stop Selection at Memory Backup Error** setting has priority over the **Run/Stop Selection at Power Up** setting.
- Relays and registers specified as **Clear All** or **Clear Specified Range** are cleared when the FC6A Series MICROSmart starts operation. The values while the power is off are retained until the power is turned on and operation is started.
- Keep/clear settings cannot be configured for special data registers. They operate the same as **Keep All**.
- Keep/clear settings cannot be configured for special internal relays. For operation when the power is shut off and when stopped, see "Devices" - "Special Internal Relay" on page 6-4.

High-Speed Counter

This section describes the high-speed counter for counting high-speed pulses from devices such as rotary encoders and proximity switches. The high-speed counter is a function that counts high-speed pulses with the FC6A Series MICROSmart hardware that cannot be read in the execution of a normal user program. The high-speed counter has a comparator function to compare the current value and a preset value (target value). When the current value and the preset value match, an external output is turned on or an interrupt program is executed.

The high-speed counter has a single-phase high-speed counter and a two-phase high-speed counter. To use high-speed counters, WindLDR function area settings are required.

■ Application example

This application example punches holes into a roll of paper at a regular interval. The two pulses (A-phase, B-phase) that carry the phase difference output from the rotary encoder are counted by the FC6A Series MICROSmart two-phase high-speed counter.

When the current value reaches the preset value, the specified external output turns on and the perforator punches a hole in the roll of paper.

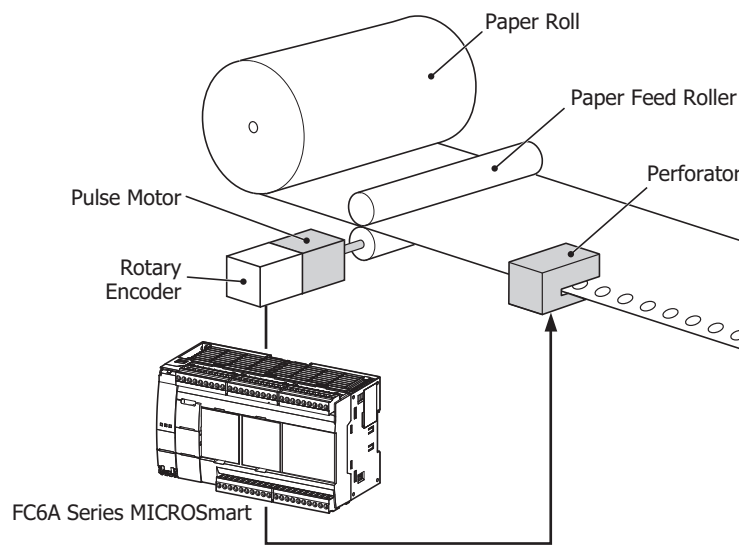

High-speed counter operation modes

The high-speed counter has the following two operation modes:

- Single-phase high-speed counter
- Two-phase high-speed counter

High-speed counting modes

The high-speed counter has the following five counting modes:

- Adding counter (single-phase high-speed counter)
- Up/down selection reversible counter (single-phase high-speed counter)
- Dual-pulse reversible counter (single-phase high-speed counter)
- 2-edge count (two-phase high-speed counter)
- 4-edge count (two-phase high-speed counter)

Example: The input allocation when external input group 1 is specified as a two-phase high-speed counter

External input	I0	I1	I2
	↓	↓	↓
High-speed counter	A-phase	B-phase	External reset input (Z-phase)

High-speed Counter External Inputs

The maximum points of the single-phase high-speed counter and two-phase high speed counter are as follows.

Type	16-I/O type	24-I/O type	40-I/O type	Plus 16-I/O type	Plus 32-I/O type
Single-phase High-speed Counter Points (maximum)	6	6	6	6	6
Two-phase High-speed Counter Points (maximum)	2	2	2	3	3

Single-phase high-speed counter

All-in-One CPU module

Group	1		2	3	4	5		6
External Input	I2	I0	I1	I3	I4	I5	I6	I7
Adding Counter	Reset input* ¹	Pulse input	Pulse input	Pulse input	Pulse input	Reset input* ¹	Pulse input	Pulse input
Up/Down Selection Reversible Counter	Reset input* ¹	Pulse input	Up/down selection input* ²	—	—	Reset input* ¹	Pulse input	Up/down selection input* ²
Dual-pulse Reversible Counter	Reset input* ¹	Pulse input (up)	Pulse input (down)* ³	—	—	Reset input* ¹	Pulse input (up)	Pulse input (down)* ³

*1 If I2 or I5 is not used as reset inputs, they can be used as normal inputs.

*2 If Group 1 and Group 5 are used as **Up/Down Selection Reversible Counter**, use I1 as the Group 1 input (up/down selection input) and use I7 as the Group 5 input (up/down selection input).

*3 If Group 1 and Group 5 are used as **Dual-Pulse Reversible Counter**, use I1 as the Group 1 input (pulse input) and I7 as Group 5 input (pulse input).

Plus CPU module

Group	1		2	3		4	5		6
External Input	I2	I0	I1	I13* ¹	I3	I4	I5	I6	I7
Adding Counter	Reset input* ²	Pulse input	Pulse input	Reset input* ²	Pulse input	Pulse input	Reset input* ²	Pulse input	Pulse input
Up/Down Selection Reversible Counter	Reset input	Pulse input	Up/down selection input* ³	Reset input	Pulse input	Up/down selection input* ³	Reset input	Pulse input	Up/down selection input* ³
Dual-pulse Reversible Counter	Reset input	Pulse input (up)	Pulse input (down)* ⁴	Reset input	Pulse input (up)	Pulse input (down)* ⁴	Reset input	Pulse input (up)	Pulse input (down)* ⁴

*1 Can be used only with the Plus 32-I/O type.

*2 If I2, I5 or I13 is not used as reset inputs, they can be used as normal inputs.

*3 If Group 1, Group 3, or Group 5 is used as **Up/Down Selection Reversible Counter**, I1 is used as the up/down selection input of Group 1, I4 is used as the up/down selection input of Group 3, and I7 is used as the up/down selection input of Group 5, respectively.

*4 If Group 1, Group 3, or Group 5 is used as **Dual-Pulse Reversible Counter**, I1 is used as the pulse input of Group 1, I4 is used as the pulse input of Group 3, and I7 is used as the pulse input of Group 5, respectively.

Two-phase high-speed counter

All-in-One CPU module

External inputs I0/I1 (Group 1-2) and I6/I7 (Group 5-6) can be used as two-phase high-speed counters.

External inputs I2 and I5 can be used as reset inputs for Group 1-2 and Group 5-6.

Group	1		2	3	4	5		6
External Input	I2	I0	I1	I3	I4	I5	I6	I7
Two-phase High-speed Counter	Reset input (Z-phase)* ¹	Pulse input (A-phase)	Pulse input (B-phase)	—	—	Reset input (Z-phase)* ¹	Pulse input (A-phase)	Pulse input (B-phase)

*1 If I2 or I5 is not used as reset inputs, they can be used as normal inputs.

Plus CPU module

External inputs I0/I1 (Group 1-2), external inputs I3/I4 (Group 3-4), and external inputs I6/I7 (Group 5-6) can be used as two-phase high-speed counters.

External inputs I2, I13 (Plus 32-I/O type only), and I5 can be used as reset inputs for Group 1-2, Group 3-4, and Group 5-6 respectively.

Group	1		2	3	4		5		6
External Input	I2	I0	I1	I13 ^{*1}	I3	I4	I5	I6	I7
Two-phase High-speed Counter	Reset input (Z-phase) ^{*2}	Pulse input (A-phase)	Pulse input (B-phase)	Reset input (Z-phase) ^{*2}	Pulse input (A-phase)	Pulse input (B-phase)	Reset input (Z-phase) ^{*2}	Pulse input (A-phase)	Pulse input (B-phase)

*1 Can be used only with the Plus 32-I/O type.

*2 If I2, I13 (Plus 32-I/O type only), or I5 is not used as reset inputs (Z-phase), they can be used as normal inputs.

High-Speed Counter Operation

The high-speed counter turns on an external output or executes an interrupt program when the current value matches the preset value (target value).

For how to configure the function to turn on an external output, see "Comparison Actions" on page 5-21.

All-in-One CPU module

■ Single-phase high-speed counter

Group 1, group 2, group 5, group 6 single-phase high-speed counter

- The high-speed counter has three operation modes, the adding counter, the up/down selection reversible counter, and the dual-pulse reversible counter.
- The up/down selection reversible counter and the dual-pulse reversible counter which can count in both directions are supported.
- These groups support 100 kHz maximum pulse input and are capable of counting in a range from 0 to 4,294,967,295 (32 bits).
- When the current value and the preset value match or an overflow or underflow occurs, a comparison output turns on or an interrupt program is executed.
- These groups support resetting the current value by the reset special internal relay or external reset input. When the reset is executed, the current value returns to the reset value specified by the special data registers. For the reset input details, see "Reset input" on page 5-28.

Counting Mode	Frequency	Reset Input
Adding counter	Group 2, 6: 100 kHz	—
	Group 1: 100 kHz	I2
	Group 5: 100 kHz	I5
Up/down selection reversible counter	Group 1-2: 100 kHz	I2
	Group 5-6: 100 kHz	I5
Dual-pulse reversible counter	Group 1-2: 100 kHz	I2
	Group 5-6: 100 kHz	I5

Group 3, group 4 single-phase high-speed counter

- These groups only support the adding counter.
- These groups support 5 kHz maximum pulse input and are capable of counting in a range from 0 to 4,294,967,295 (32 bits).
- When the current value and the preset value match or an overflow or underflow occurs, an external output turns on or an interrupt program is executed.
- These groups only support the reset input via a special internal relay. When the reset is executed, the current value returns to the reset value specified by the special data registers.

Counting Mode	Frequency	Reset Input
Adding counter	Group 3, 4: 5 kHz	—

■ Two-phase high-speed counter

Group 1-2, group 5-6 two-phase high-speed counter

- The two-phase high-speed counter counts by the phase difference between the A-phase and B-phase pulse input.
- These groups support 50 kHz maximum pulse input and are capable of counting in a range from 0 to 4,294,967,295 (32 bits).
- Even higher speed counting is possible by specifying 2-edge count or 4-edge count.
- When the current value and the preset value match or an overflow or underflow occurs, an external output turns on or an interrupt program is executed.
- These groups support resetting the current value by the reset special internal relay or external reset input (Z-phase). When the reset is executed, the current value returns to the reset value specified by the special data registers.

Counting Mode	Frequency	Reset Input (Z-phase)
2-edge count	Group 1-2: 50 kHz	I2
	Group 5-6: 50 kHz	I5
4-edge count	Group 1-2: 25 kHz	I2
	Group 5-6: 25 kHz	I5

Plus CPU module

■ Single-phase high-speed counter

- The single-phase high-speed counter has three operation modes, the adding counter, the up/down selection reversible counter, and the dual-pulse reversible counter.
- The up/down selection reversible counter and the dual-pulse reversible counter which can count in both directions are supported.
- This counter support 100 kHz (pulse width $\geq 5 \mu\text{s}$) maximum pulse input and is capable of counting in a range from 0 to 4,294,967,295 (32 bits).
- When the current value and preset value match or an overflow or underflow occurs, a comparison output turns on or an interrupt program is executed.
- This counter support resetting the current value by special internal relay reset input and reset input. When the reset input is turned on or when the current value reset is executed, the current value becomes the reset value specified by special data registers. For details on the reset input, see "Reset input" on page 5-28.

Counting Mode	Frequency	Reset Input
Adding counter	Group 2, 4, 6: 100 kHz	—
	Group 1: 100 kHz	I2
	Group 3: 100 kHz	*1
	Group 5: 100 kHz	I5
Up/down selection reversible counter	Group 1 to 2: 100 kHz	I2
	Group 3 to 4: 100 kHz	*1
	Group 5 to 6: 100 kHz	I5
Dual-pulse reversible counter	Group 1 to 2: 100 kHz	I2
	Group 3 to 4: 100 kHz	*1
	Group 5 to 6: 100 kHz	I5

*1 The Plus 16-I/O type supports only reset input by special internal relay.
The Plus 32-I/O type can use I13 as an external reset input.

■ Two-phase high-speed counter

Group 1 to 2, group 3 to 4, group 5 to 6 two-phase high-speed counter

- The two-phase high-speed counter counts with the phase difference between A-phase and B-phase pulse inputs.
- These groups support 50 kHz maximum pulse input and are capable of counting in a range from 0 to 4,294,967,295 (32 bits).
- Even higher speed counting is possible by specifying 2-edge count or 4-edge count.
- When the current value and preset value match or an overflow or underflow occurs, a comparison output turns on or an interrupt program is executed.
- These groups support resetting the current value by special internal relay reset input and external reset input (Z-phase). When the reset input is turned on or the current value reset is executed, the current value becomes the reset value specified by special data registers.

Counting Mode	Frequency	Reset Input (Z-phase)
2-edge count	Group 1 to 2: 50 kHz	I2
	Group 3 to 4: 50 kHz	*1
	Group 5 to 6: 50 kHz	I5
4-edge count	Group 1 to 2: 25 kHz	I2
	Group 3 to 4: 25 kHz	*1
	Group 5 to 6: 25 kHz	I5

*1 The Plus 16-I/O type supports only reset input by special internal relay.
The Plus 32-I/O type can use I13 as an external reset input.

Counting mode

The high-speed counter as the following five counting modes.

■ **Adding counter (single-phase high-speed counter)**

The adding counter counts up with the rise in pulse input.

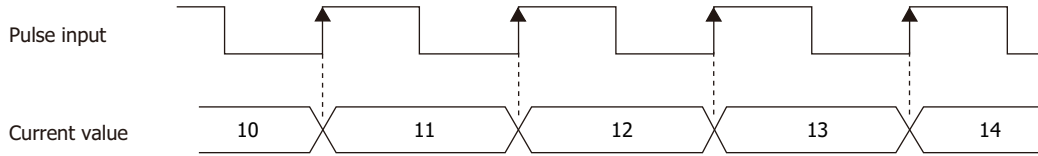

■ **Up/down selection reversible counter (single-phase high-speed counter)**

Up/down selection reversible counter can switch between addition and subtraction by pulse input with the up/down selection input. When the up/down selection input is on, the counter counts up with the rise in pulse input. When the up/down selection input is off, the counter counts down with the rise in pulse input.

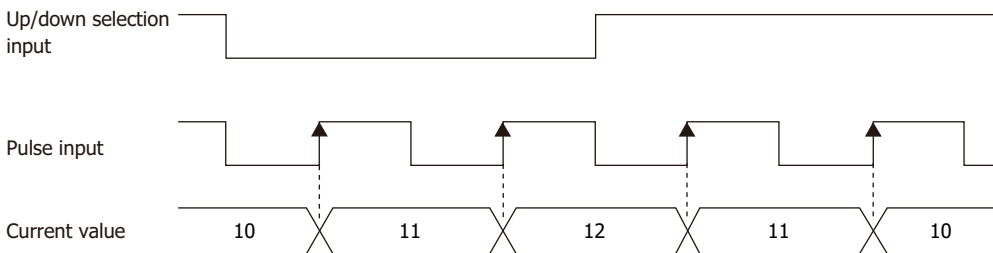

■ **Dual-pulse reversible counter (single-phase high-speed counter)**

This counter switches between the up count and the down count with pulse input (up) and pulse input (down). When a pulse is input to pulse input (up), the counter counts up with the rise in pulse input. When a pulse is input to pulse input (down), the counter counts down with the rise in pulse input.

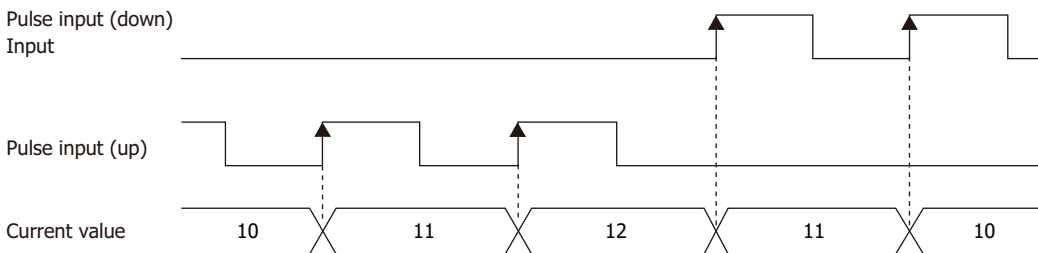

■ **2-edge count (two-phase high-speed counter)**

This counter counts by the phase difference between the A-phase and B-phase pulse input. When the A-phase precedes the B-phase, the counter counts up with the rise and fall of the B-phase. When the B-phase precedes the A-phase, the counter counts down with the rise and fall of the B-phase.

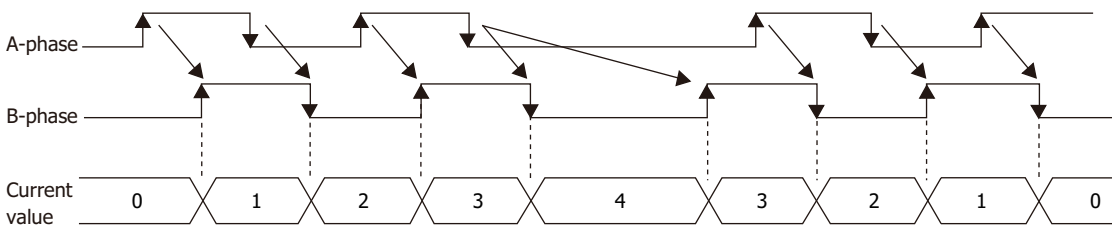

■ **4-edge count (two-phase high-speed counter)**

This counter counts by the phase difference between the A-phase and B-phase pulse input. When the A-phase precedes the B-phase, the counter counts up with the rise and fall of the A-phase and the B-phase. When the B-phase precedes the A-phase, the counter counts down with the rise and fall of the A-phase and the B-phase.

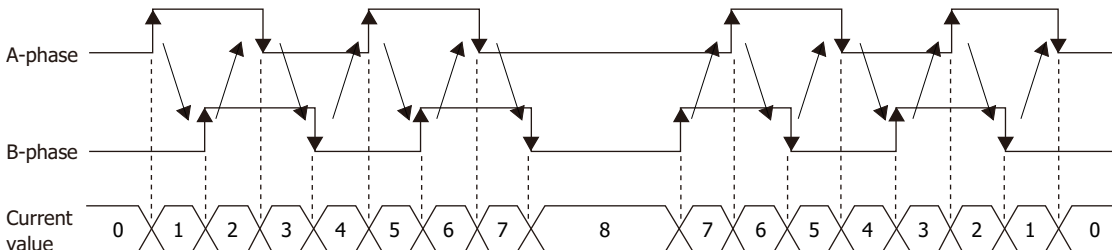

Comparison Actions

The operating condition when comparing values is configured in the WindLDR **High-speed Counter Settings**, under **Comparison Action**.

The action when comparing values is **Comparison Output** or **Interrupt Program**, so specify an external output number or label number when comparing.

Operation

When the preset value and the current value are compared and the values match, the specified output is turned on or the interrupt program is executed.

A maximum of six high-speed counter preset values can be configured. For one preset value, the current value is compared with the same preset value each time.

When multiple preset values are configured, the preset value is changed each time the current value and preset value match.

For example, if four preset values are configured, when preset value 1 matches the current value, the comparison subject changes to preset value 2 → 3 → 4 in order.

When the final preset value 4 matches the current value, the preset value returns to preset value 1 and the values are compared.

■ Preset value storage locations

The preset values during high-speed counter operation are stored as 2 words in special data registers.

Single-phase high-speed counter (Adding counter)

Group		1	2	3	4	5	6	Read/Write
Preset Value	Upper Word	D8212	D8194	D8220	D8224	D8228	D8200	R
	Lower Word	D8213	D8195	D8221	D8225	D8229	D8201	

Single-phase high-speed counter (Up/down selection reversible counter, dual-pulse reversible counter), two-phase high-speed counter

All-in-One CPU module

Group		1	2	3	4	5	6	Read/Write
Preset Value	Upper Word	D8212		—		D8228		R
	Lower Word	D8213		—		D8229		

Plus CPU module

Group		1	2	3	4	5	6	Read/Write
Preset Value	Upper Word	D8212		D8220		D8228		R
	Lower Word	D8213		D8221		D8229		

Note: In the WindLDR **Function Area Settings**, when **32-bit Data Storage Setting** is set to **From Lower Word**, the lower word is stored in the first device.

Specify the data registers to store the preset values in WindLDR and store those preset values in the user program. Specify the start address of the data registers to allocate the data registers to the individual settings in the comparison settings. When the high-speed counter is executed, the preset value with the number stored in **Current Comparison Number** is active. The active preset value number for each comparison is stored in **Current Comparison Number** and the next active preset value number is automatically stored in **Next Comparison Number**. By changing the value of **Next Comparison Number** in the user program, the next active preset value number can be changed. The active preset value is stored for each group in the special data registers shown in the table above.

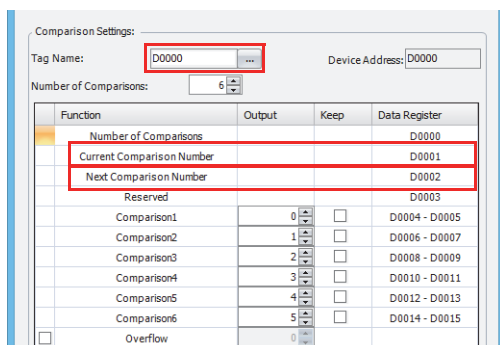

5: FUNCTIONS AND SETTINGS

Example: Group 1, number of comparisons is 3, set to device address D0

When the current value matches preset value 1, **Current Comparison Number** becomes 2 and 3 is stored in **Next Comparison Number**.

When the device address is configured as D0, **Current Comparison Number** is stored in D1 and **Next Comparison Number** is stored in D2.

For the group 1 preset value, the value of the data registers (D4, D5) allocated to preset value number 1 is stored in D8212 and D8213 as shown in the table above and it is compared to the current value.

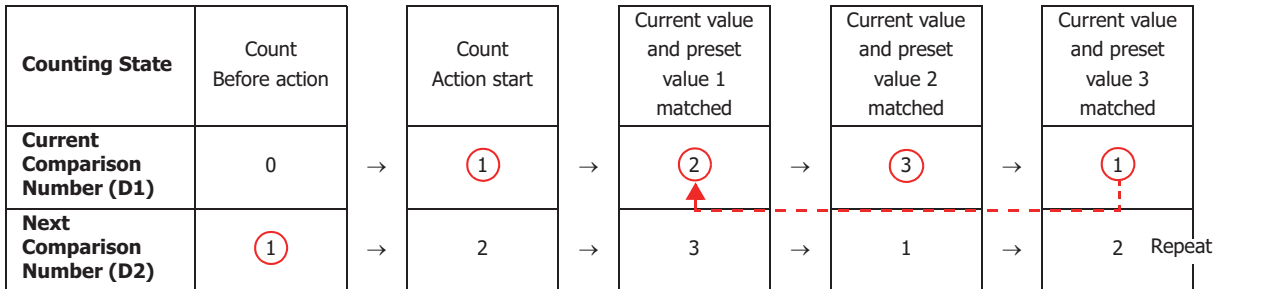

Before the count action, set **Current Comparison Number** to 0, and set **Next Comparison Number** and preset values 1 to 3 to the count values with the initialize pulse in the user program.

Preset value 1 is set to **Current Comparison Number**

Preset value 2 is set.

Preset value 3 is set.

Once again, preset value 1 is set.

Note: When the **Next Comparison Number** preset value becomes active, the high-speed counter preset value during execution does not change, even when the preset value for that preset value number is changed. When the current value and the current preset value match, the preset value with the number stored in **Next Comparison Number** becomes active. Changes to the **Next Comparison Number** data register must be performed before the preset value becomes active.

Comparison operation flow

The comparison operation flow is as follows.

1. Start (run) the FC6A Series MICROSmart.

For the first scan, **Current Comparison Number** is set to 0, and **Next Comparison Number** is set to the number for preset value 1 with the initialize pulse.

For the second scan, an I/O refresh is performed in END processing and the value of **Next Comparison Number** is transferred to **Current Comparison Number**.

The content of **Next Comparison Number** becomes the preset value n + 1 ("2" in this example).

When **Number of Comparisons** is 1, **Next Comparison Number** is always "1".

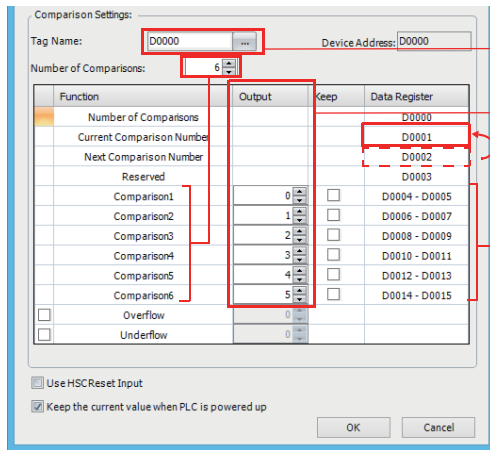

The data register that stores the preset value (target value). Specify the starting address.

The outputs (external outputs) when the values match.

Transfer

The preset value with the number that became active is the comparison subject with the current value and is stored in the special data registers.

Example: For group 1

Storage destination for the preset value that became active.

Stored by group.

Group	1	Read/Write
Preset Value (Upper word)	D8212	R/W
Preset Value (Lower word)	D8213	

2. Start the high-speed counter count operation.
Turn on the gate input to start the count operation.
3. Compare the **Current Comparison Number** preset value and the current value. When the current value and the preset value match, the next number for the preset value becomes active and the high-speed counter continues counting.
Execute **Comparison Output** or **Interrupt Program**. (**Comparison Output** in this example)
 - Turn on the comparison (special internal relay) for only one scan.
 - Overwrite **Current Comparison Number** with **Next Comparison Number** and start the count with the preset value for **Current Comparison Number**.
 - Add 1 to **Next Comparison Number**.
4. When the procedure is executed up to preset value 6, repeat again from the beginning with preset value 1.

Note: The **Current Comparison Number** data register cannot be written to during the count action. It is read-only. **Next Comparison Number** and **Comparison 1** to **Comparison 6** can be read and written to.

Programming WindLDR

To use the high-speed counter, a normal external input must be specified as **Two/Single-phase High-speed Counter** in the WindLDR **Function Area Settings**. The function for external input groups on the FC6A Series MICROSmart can be selected as normal input, high-speed counter, catch input, interrupt input, and frequency measurement.

When using normal input, catch input, interrupt input, or frequency measurement, the high-speed counter cannot be used. However, the interrupt program can only be used when ladder program is selected as the programming language.

1. From the WindLDR menu bar, select **Configuration > Input Configuration**. The **Function Area Settings** dialog box is displayed.
2. Select **Two/Single-phase High-speed Counter** for the group to use the high-speed counter.

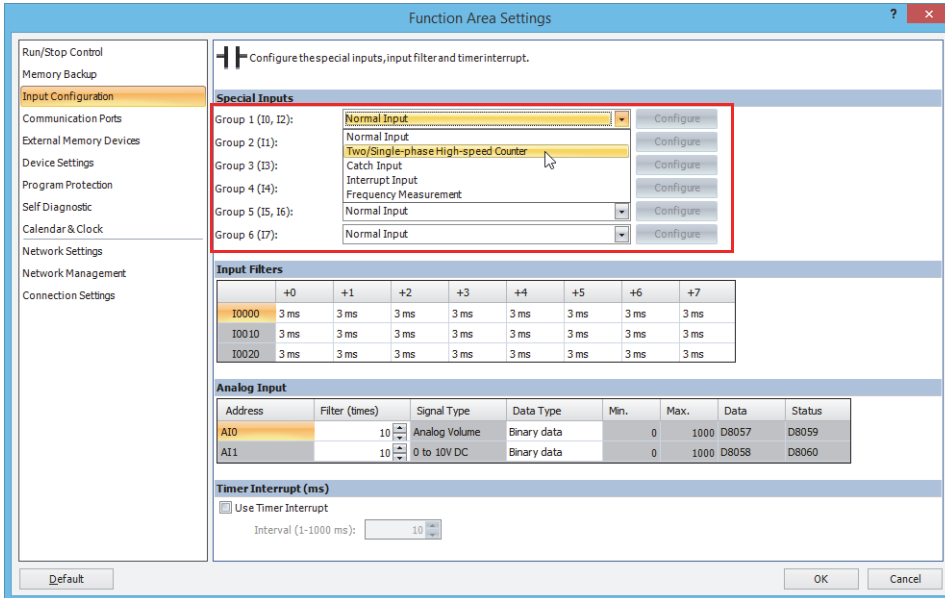

The **High-speed Counter Settings** dialog box is displayed.

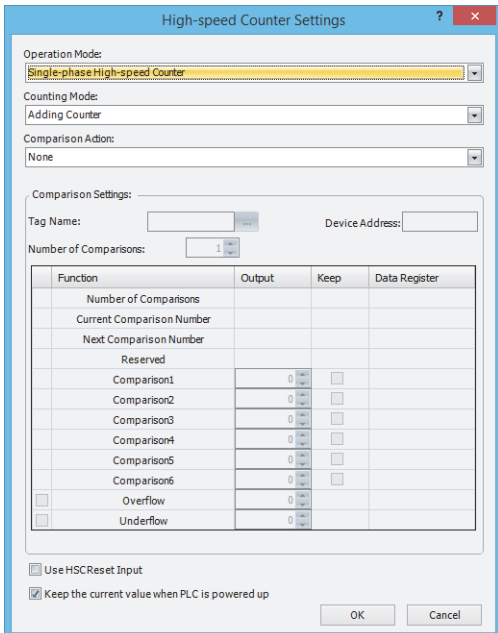

3. Configure the operation mode and the counting mode. To use comparison actions, configure the comparison settings.
4. Click **OK**.

This concludes configuring the settings.

Settings

■ Operation mode

For group 1 and group 5, you can select **Single-phase High-speed Counter** or **Two-phase High-speed Counter**.

Only **Single-phase High-speed Counter** can be selected for Group 2, Group 4, and Group 6.

The operation mode that can be selected for Group 3 depends on the type of FC6A Series MICROSmart.

Only **Single-phase High-speed Counter** can be selected for the All-in-One CPU module. **Single-phase High-speed Counter** and **Two-phase High-speed Counter** can be selected for the Plus CPU module.

■ Counting mode (single-phase high-speed counter)

When the **Single-phase High-speed Counter** is specified for **Operation Mode** of Group 1 or Group 5, **Counting Mode** can be selected as **Adding Counter**, **Up/Down Selection Reversible Counter**, or **Dual-Pulse Reversible Counter**.

Only **Adding Counter** can be selected for Group 2, Group 4, and Group 6 high-speed counters.

The counting mode that can be selected for Group 3 depends on the type of FC6A Series MICROSmart.

Only **Adding Counter** can be selected for the All-in-One CPU module. **Adding Counter**, **Up/Down Selection Reversible Counter**, and **Dual-Pulse Reversible Counter** can be selected for the Plus CPU module.

Adding counter

The adding counter counts up with the rise in pulse input.

Up/down selection reversible counter

Up/down selection reversible counter can switch between addition and subtraction with the up/down selection input. When the up/down selection input is on, the counter counts up with the rise in pulse input. When the up/down selection input is off, the counter counts down with the rise in pulse input.

Dual-pulse reversible counter

This counter switches between the up count and the down count with pulse input (up) and pulse input (down) pulses. When a pulse is input to pulse input (up), the counter counts up with the rise in the pulse. When a pulse is input to pulse input (down), the counter counts down with the rise in pulse input.

Note: When Group 1, Group 3 (Plus CPU module), or Group 5 is set to **Up/Down Selection Reversible Counter**, **Dual-Pulse Reversible Counter**, or **Two-phase High-speed Counter**, Group 2, Group 4, or Group 6 has the same setting.

■ Counting mode (two-phase high-speed counter)

When the two-phase high-speed counter is specified for **Operation mode** for group 1, group 3 (Plus CPU module), or group 5, the counting mode can be selected as **2-edge count** or **4-edge count**.

2-edge count

This counter counts at double the frequency of the input pulse.

This counter counts by the phase difference between the A-phase and B-phase pulse input. When the A-phase precedes the B-phase, the counter counts up with the rise and fall of the B-phase. When the B-phase precedes the A-phase, the counter counts down with the rise and fall of the B-phase.

4-edge count

This counter counts at quadruple the frequency of the input pulse.

This counter counts by the phase difference between the A-phase and B-phase pulse input. When the A-phase precedes the B-phase, the counter counts up with the rise and fall of the A-phase and the B-phase. When the B-phase precedes the A-phase, the counter counts down with the rise and fall of the A-phase and the B-phase.

■ Comparison action

The comparison action is a function that compares the high-speed counter's current value with a preset value (target value).

It can use either the comparison output or an interrupt program. However, the interrupt program can only be used when ladder program is selected as the programming language.

- When **Comparison Output** is selected, the specified external output is turned on when the current value and the preset value match.
- When **Interrupt Program** is selected, the subroutine program with the specified label number is executed as the interrupt program when the current value and the preset value match.

Overflow and underflow can also be used for the comparison conditions.

For details on the comparison actions, see "Comparison Actions" on page 5-21.

■ **Comparison settings**

When using the comparison output or the interrupt program as the comparison action for the high-speed counter, configure the external output number or the label number when there is a match. A maximum of six preset values can be specified for **Number of Comparisons** (preset value number 1 to 6).

Tag name

This setting specifies the starting address of the data register region to store the preset values.

Device address

This item shows the address of the data register specified by the tag name.

Number of Comparisons

You can configure a maximum of six preset values (target values) for the comparison action.

Notes:

- The preset value becomes active by the END processing in the second scan after the FC6A Series MICROSmart starts operation. Store **Preset Value** in the data registers with initialize pulse M8120 input.
- When the preset value (special data register) is changed before the comparison, the preset value currently being used for the comparison is discarded in the program's END processing, and the comparison is performed with the newly configured preset value.
- Configure the settings so that an interval of 1 ms or more is present between instances of the preset value and the current value matching. If this interval is less than 1 ms in length, the next Comparison ON status may be missed.

Output

When a comparison action is selected, these are the external outputs specified for preset value 1 to 6.

The external outputs that can be used as comparison outputs are listed by model as follows. Remote outputs cannot be configured.

Model Number	Comparison Output
16-I/O type	Q0 to Q6
24-I/O type	Q0 to Q11
40-I/O type	Q0 to Q17
Plus 16-I/O type	Q0 to Q7
Plus 32-I/O type	Q0 to Q17

Overflow

Select this check box to use overflow in the comparison action conditions (when the current value exceeds 4,294,967,295).

Underflow

Select this check box to use underflow in the comparison action conditions (when the current value falls below 0).

Note: When the comparison action is **Comparison Output** and either a preset value, overflow, or underflow has been enabled as a comparison condition, the text box to enter the comparison output is enabled. The comparison output can be specified for each of these match conditions.

■ **Keep**

After the current value matches the preset value, select to reset the current value to a reset value or to keep the value. Select this check box to keep the current value.

■ **Use HSC Reset Input**

Select this check box to reset the current value to the reset value with an external input (high-speed counter reset input). High-speed counter reset input can only be specified for group 1, group 3 (Plus 32-I/O type), and group 5.

Group	External Input
Group 1	I2
Group 3	*1
Group 5	I5

*1 The All-in-One CPU module and Plus 16-I/O type support only reset input by special internal relay. The Plus 32-I/O type can use I13 as an external reset input.

When the high-speed counter reset input is turned on, the current value is reset to the reset value.

If the high-speed counter reset input is not used, I2, I13, and I5 are normal inputs.

■ **Keep current values at power on**

Select this check box to maintain the current values that have been kept with the backup battery at power on.

If this check box is cleared, the current values are initialized to 0.

High-speed counter devices

The high-speed counter operates according to special internal relay and special data register settings. While the high-speed counter is operating, the current value, control output, and operating status value are reflected in the special internal relays and special data registers with each scan.

The high-speed counter start and stop control signals and the current value, preset values, and reset values are allocated to the special internal relays and special data registers.

Device allocation table

The devices used by the high-speed counter are as follows.

Special internal relay list

Group	1	2	3	4	5	6	Read/Write
Comparison Output Reset	M8030	M8051	M8034	M8040	M8044	M8057	R/W
Gate Input	M8031	M8052	M8035	M8041	M8045	M8060	
Reset Input	M8032	M8053	M8036	M8042	M8046	M8061	
Reset Status	M8130	—	M8600	—	M8135	—	R
Comparison ON Status	M8131	M8054	M8133	M8134	M8136	M8062	
Overflow	M8161	M8055	M8165	M8166	M8163	M8063	
Underflow	M8162	—	M8601	—	M8164	—	
Count Direction Flag	M8027	—	M8602	—	M8043	—	

Special data register list

Group	1	2	3	4	5	6	Read/Write
Current Value (Upper word)	D8210	D8192	D8218	D8222	D8226	D8198	R
Current Value (Lower word)	D8211	D8193	D8219	D8223	D8227	D8199	
Preset Value (Upper word)	D8212	D8194	D8220	D8224	D8228	D8200	
Preset Value (Lower word)	D8213	D8195	D8221	D8225	D8229	D8201	
Reset Value (Upper word)	D8216	D8196	D8234	D8236	D8232	D8202	R/W
Reset Value (Lower word)	D8217	D8197	D8235	D8237	D8233	D8203	

When using the devices above with instructions where the data type unit can be specified, specify the data type as double word (D). In the WindLDR **Function Area Settings**, when **32-bit Data Storage Setting** is set to **From Lower Word**, the lower word is stored in the first device.

■ Start/stop high-speed counter

The high-speed counter can be started and stopped per group by turning the gate input on or off.

Group	1	2	3	4	5	6	Read/Write
Gate Input	M8031	M8052	M8035	M8041	M8045	M8060	R/W

■ Current value storage locations

The current value for the single-phase high-speed counter is stored in special data registers as 2 words per group.

Group	1	2	3	4	5	6	Read/Write
Current Value (Upper word)	D8210	D8192	D8218	D8222	D8226	D8198	R
Current Value (Lower word)	D8211	D8193	D8219	D8223	D8227	D8199	

In the WindLDR **Function Area Settings**, when **32-bit Data Storage Setting** is set to **From Lower Word**, the lower word is stored in the first device.

■ Comparison ON status

When the current value and the preset value match, the special internal relay turns on for only one scan.

Group	1	2	3	4	5	6	Read/Write
Comparison ON Status	M8131	M8054	M8133	M8134	M8136	M8062	R

5: FUNCTIONS AND SETTINGS

■ Overflow

When the current value exceeds 4,294,967,295, the special internal relay turns on for only one scan. When the current value overflows, it becomes 0.

Group	1	2	3	4	5	6	Read/Write
Overflow	M8161	M8055	M8165	M8166	M8163	M8063	R

■ Underflow

When the current value falls below 0, the special internal relay turns on for only one scan. When the current value underflows, it becomes 4,294,967,295.

Group	1	2	3	4	5	6	Read/Write
Underflow	M8162	—	M8601	—	M8164	—	R

■ Comparison output reset

When the special internal relay turns on, the comparison output selected on **High-speed Counter Settings** turns off.

Group	1	2	3	4	5	6	Read/Write
Comparison Output Reset	M8030	M8051	M8034	M8040	M8044	M8057	R/W

■ Reset input

When reset input is turned on, the current value returns to the reset value.

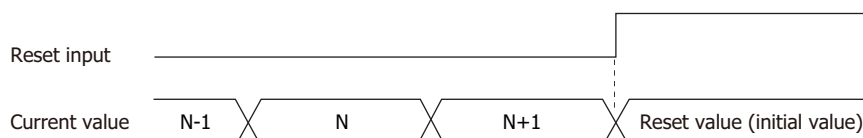

Group	1	2	3	4	5	6	Read/Write
Reset Input	M8032	M8053	M8036	M8042	M8046	M8061	R/W

■ Preset value, reset value storage locations

The preset value and the reset value for the high-speed counter are stored in special data registers as 2 words.

Group	1	2	3	4	5	6	Read/Write
Preset Value (Upper word)	D8212	D8194	D8220	D8224	D8228	D8200	R
Preset Value (Lower word)	D8213	D8195	D8221	D8225	D8229	D8201	
Reset Value (Upper word)	D8216	D8196	D8234	D8236	D8232	D8202	R/W
Reset Value (Lower word)	D8217	D8197	D8235	D8237	D8233	D8203	

In the WindLDR **Function Area Settings**, when **32-bit Data Storage Setting** is set to **From Lower Word**, the lower word is stored in the first device.

■ HSC reset input and reset status

When the HSC reset input is enabled in group 1, group 3 (Plus 32-I/O type), or group 5, turn on HSC reset input I2, I13, or I5 to return the current value to the reset value.

In this situation, reset status turns on for only one scan.

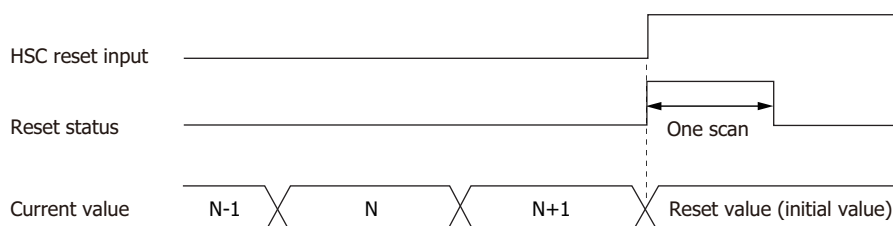

Group	1	2	3	4	5	6	Read/Write
HSC Reset Input	I2	—	I13	—	I5	—	—
Reset Status	M8130	—	M8600	—	M8135	—	R

To use the reset input with the group 1, group 3, or group 5 single-phase high-speed counter, use I2, I13, or I5. When not using I2, I13, or I5 as an external reset input, they can be used as normal input.

■ Count direction flag

These special internal relays maintain whether the Group 1, Group 3, or Group 5 current value is being added or subtracted. When these special internal relays are on, they indicate addition. When they are off, they indicate subtraction.

Group	1	2	3	4	5	6	Read/Write
Count Direction flag	M8027	—	M8602	—	M8043	—	—

Timing chart 1

Single-phase high-speed counter (group 1) timing chart

Operating conditions

The counting mode is set to **Up/down selection reversible counter** and reset input (I2) is used.

One preset value is used, and when the values match, output Q1 turns on and the current value is kept.

Overflow and underflow are not used.

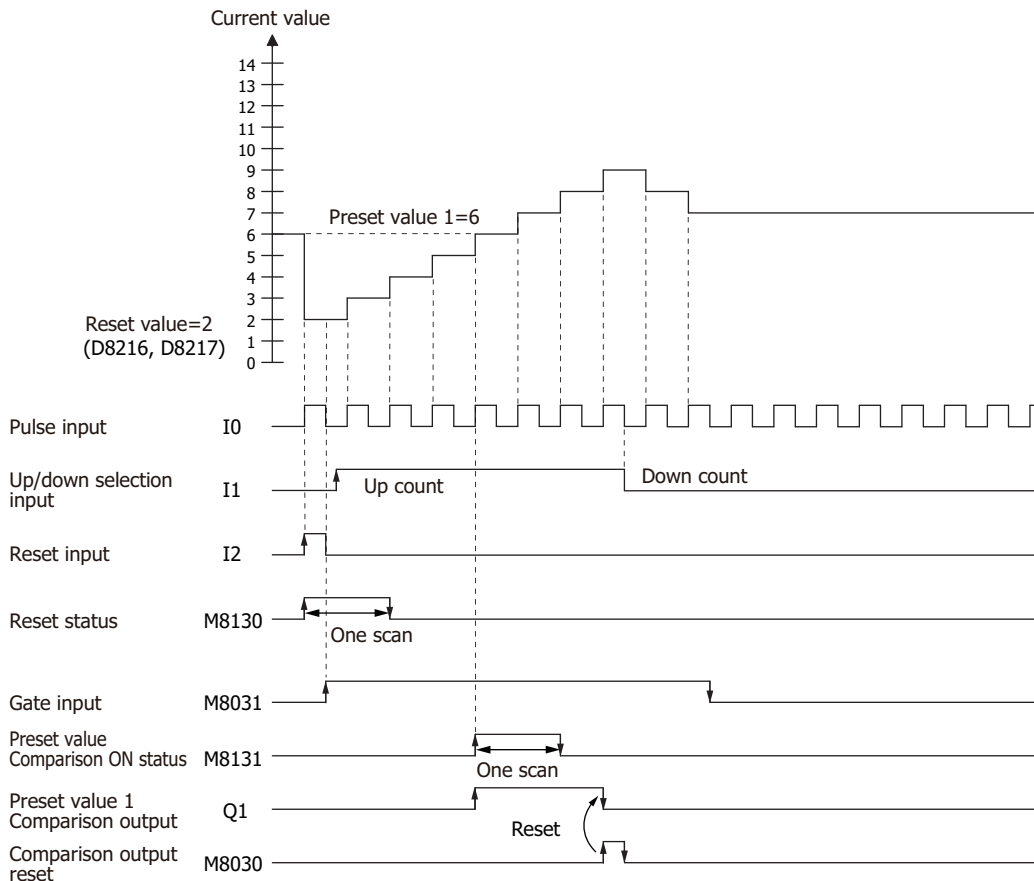

1. When reset input (I2) turns on, the reset value (D8216, D8217) is stored in the current value (D8210, D8211). In this situation, reset status (M8130) turns on for only one scan.
2. When gate input (M8031) turns on, the counting begins.
3. The counting direction (count up/count down) is determined by the on/off state of the up/down selection input (I1), and the pulse input (I0) is counted. The current value is updated with each scan.
4. When the current value and preset value 1 (D8212, D8213) match, the preset value 1 comparison output (Q1) and Comparison ON status (M8131) turn on. When the **Keep** check box is selected in the settings in the WindLDR **High-speed Counter Settings**, the current value is kept.
5. Q1 maintains the on state until comparison output reset (M8030) turns on. M8131 turns on for only one scan.
6. When the gate output turns off, counting stops.

Note: High-speed counter usage precautions

The high-speed counter starts the count operation with the following two conditions:

- The FC6A Series MICROSmart starts operation
- The gate input is turned on

To start the count operation, turn the gate input on from off while the FC6A Series MICROSmart is running. When the gate input is already on and the FC6A Series MICROSmart is stopped, the count operation starts when the FC6A Series MICROSmart is switched from stop to run.

If run-time download is performed on the program when the gate input is on, the count operation stops.

When the PLC is in the RUN state (the PLC must be operating in RUN for three or more scans), the count operation is possible by turning the gate input off and then on or by stopping and then running the PLC. When performing run-time download on the program, we recommend doing so with the gate inputs off.

Timing chart 2

Two-phase high-speed counter (group 1) timing chart

Operating conditions

The counting mode is set to **2-edge count** and reset input (I2) is used.

Two preset values are used, and when preset value 1 matches, output Q1 turns on and the current value is kept.

When preset value 2 matches, output Q2 turns on and the current value is cleared.

Overflow and underflow are not used.

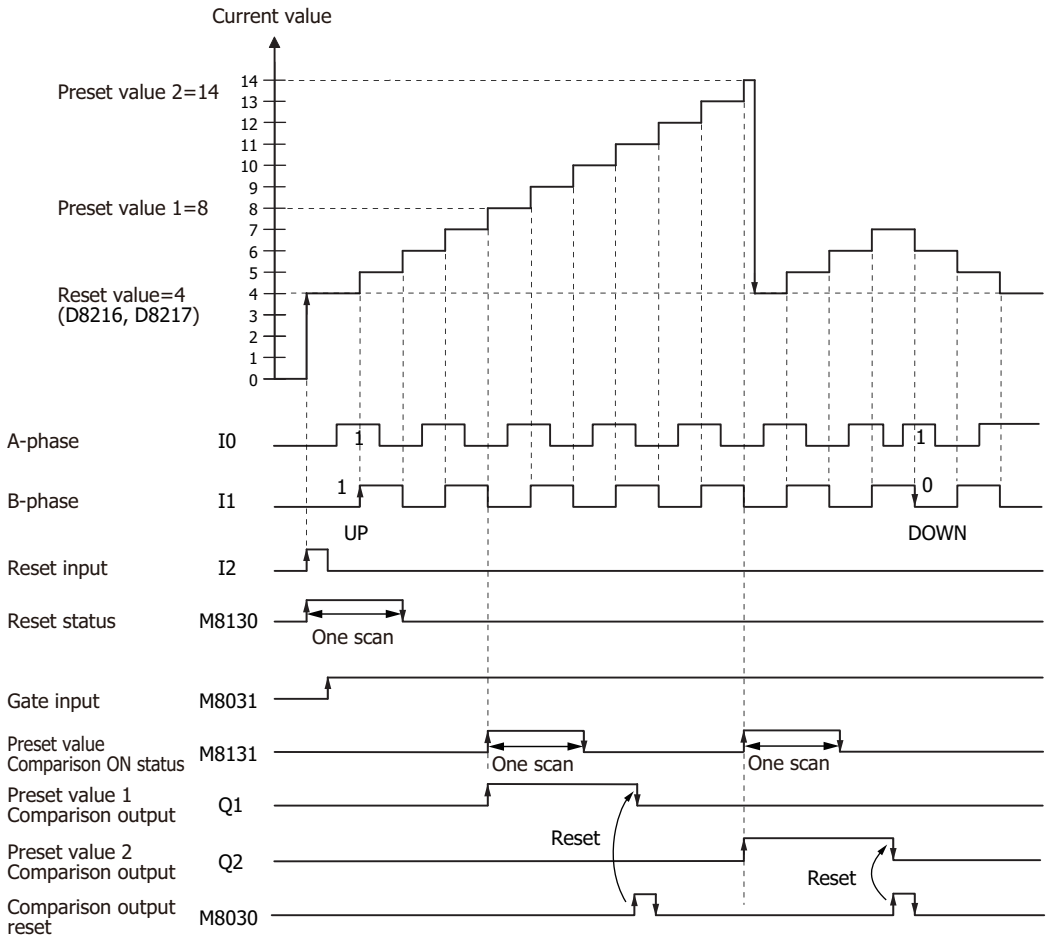

1. When reset input (I2) turns on, the reset value (D8216, D8217) is stored in the current value (D8210, D8211). In this situation, reset status (M8130) turns on for only one scan.
2. When gate input (M8031) turns on, the counting begins.
3. When the A-phase pulse (I0) precedes the B-phase pulse (I1), the count goes up. When the B-phase pulse (I1) precedes the A-phase pulse (I0), the count goes down.
4. When the current value and preset value 1 (D8212, D8213) match, the preset value 1 comparison output (Q1) and setting value match (M8131) turn on.
5. When preset value 1 matches, preset value 2 is stored in the preset value (D8212, D8213) as the new preset value and counting continues.
6. The preset value 1 comparison output (Q1) maintains the on state until comparison output reset (M8030) turns on. M8131 turns on for only one scan.

Example program 1

Using the single-phase high-speed counter on the ladder program, this example program turns on external output Q2 when 1,000 pulses are counted.

Application description

When pulses are input to external input I0 and the count reaches 1,000, external output Q2 is turned on.

In the WindLDR **Function Area Settings**, select **Two/Single-phase High-speed Counter** for **Group 1**.

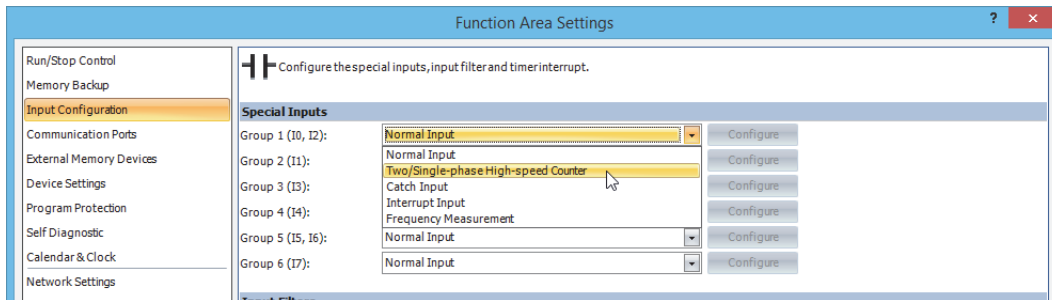

In the **High-speed Counter Settings** dialog box, configure the settings as follows.

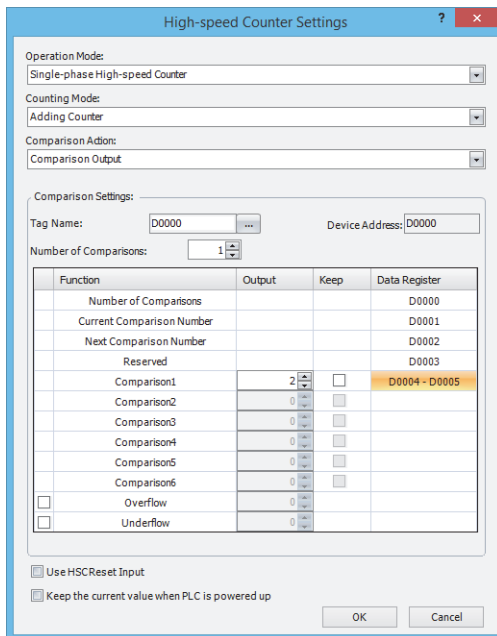

- External Input : Group 1
- Operation Mode : Single-phase High-speed Counter
- Counting Mode : Adding Counter
- Comparison Action : Comparison Output

Comparison settings

- Tag Name/Device Address : D0000 (data register)
- Number of Comparisons : 1
- Comparison Output : Q2 (external output when matched)
- Comparison1 (D0004) : 0 (upper word)
- Comparison1 (D0005) : 1,000 (lower word)
- Keep : Cleared
- Reset value (D8216) : 0 (upper word)
- Reset value (D8217) : 0 (lower word)
- Overflow : Cleared
- Underflow : Cleared
- Use HSC Reset Input : Cleared
- Keep the current value when PLC is powered up : Cleared

Program

M8120 (initialize pulse) is a special internal relay that turns on when the FC6A Series MICROSmart runs.

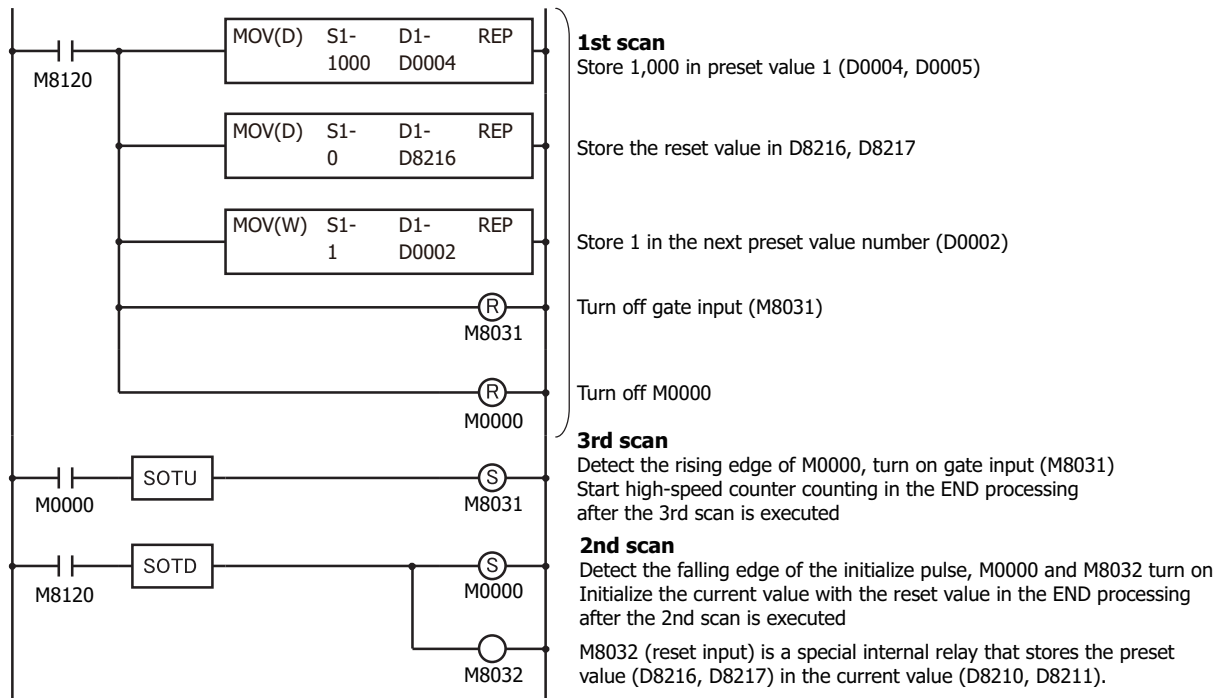

Example program 2

Using the two-phase high-speed counter, the pulses from a rotary encoder are input to the FC6A Series MICROSmart and a continuous workpiece is marked at a regular interval.

Application description

- The rotary encoder pulses are input to external input I0. A continuous sheet of paper is marked (holes are punched) at a regular interval (every 2,700 pulses).
- The rotary encoder is directly connected to the paper feed roller, and output pulses are counted by the high-speed counter and controlled.
- The cycle time is the time to count 2,700 pulses. When the hole punch time is 0.5 seconds, the operation condition is 2,700 pulse count time > 0.5 seconds.

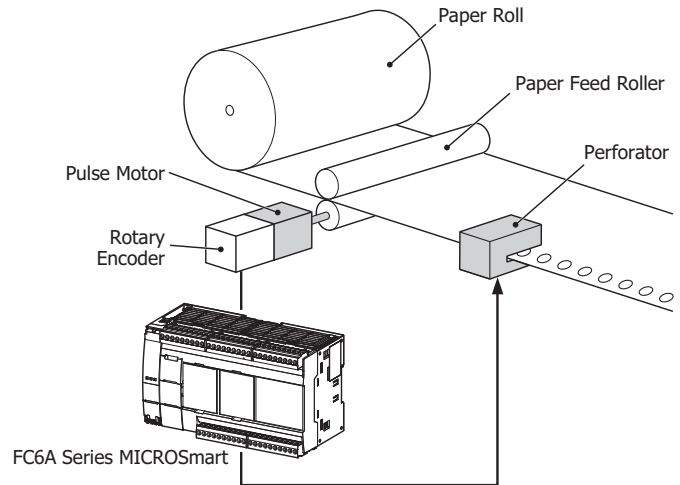

In the WindLDR **Function Area Settings**, select **Two/Single-phase High-speed Counter** for **Group 1**.

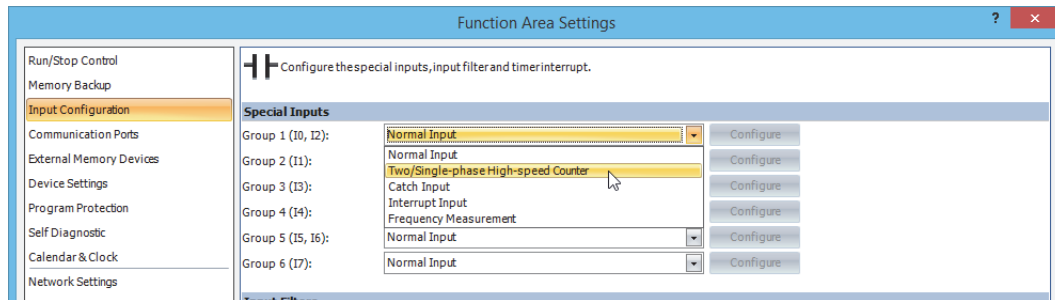

In the **High-speed Counter Settings** dialog box, configure the settings as follows.

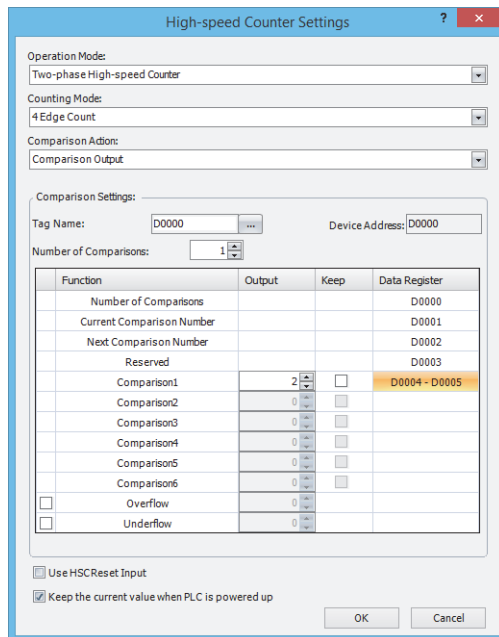

- External Input : Group 1
- Operation Mode : Two-phase High-speed Counter
- Counting Mode : 4-edge Count
- Comparison Action : Comparison Output

Comparison settings

- Tag Name/Device Address : D0000 (data register)
- Number of Comparisons : 1
- Comparison Output : Q2 (external output when matched)
- Comparison1 (D0004) : 0 (upper word)
- Comparison1 (D0005) : 2,700 (lower word)
- Keep : OFF
- Reset value (D8216) : 0 (upper word)
- Reset value (D8217) : 0 (lower word)
- Overflow : OFF
- Underflow : OFF
- Use HSC Reset Input : OFF
- Keep the current value when PLC is powered up : Checked

Program

M8120 (initialize pulse) is a special internal relay that turns on when the FC6A Series MICROSmart runs.

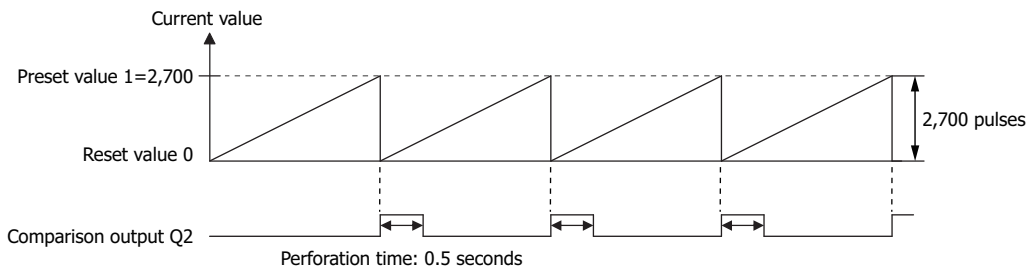
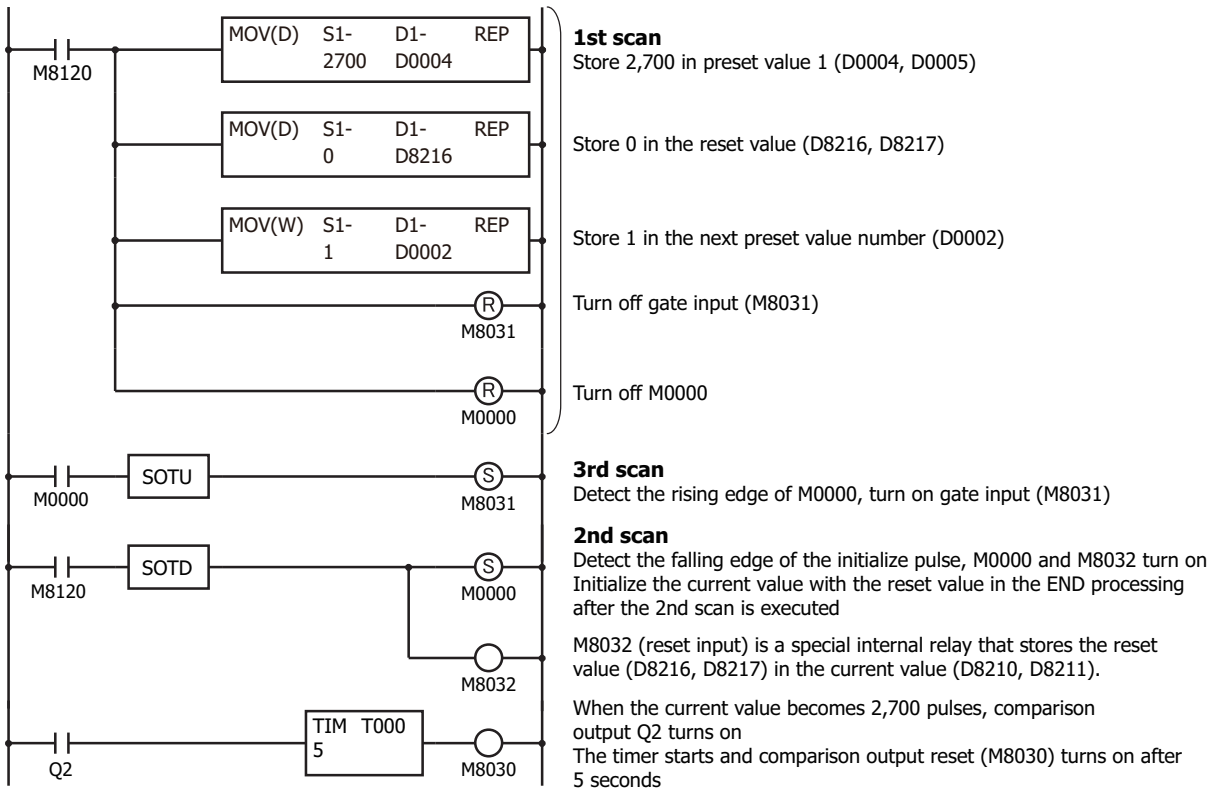

Note: In this example, Z-phase reset input is not used.

Catch Input

The catch input function is used to receive short pulses from sensor outputs regardless of the scan time. Input pulses shorter than one scan time can be received. When using catch input, the on/off status according to the status of the external inputs during one scan is stored in the special internal relays (M8153 to M8157, M8160) that correspond to each external input group, and those signals can be used as input conditions.

The **Function Area Settings** dialog box is used to designate inputs I0, I1, I3, I4, I6 and I7 as a catch input.

Normal input signals to input terminals are read when the END instruction is executed at the end of a scan.

Since these settings relate to the user program, the user program must be downloaded to the FC6A Series MICROSmart after changing any of these settings.

Catch Input Specifications

Minimum Turn ON Pulse Width	5 μs
Minimum Turn OFF Pulse Width	5 μs

Note: Input filter settings have no effect on the catch inputs. For the input filter function, see "Input Filter" on page 5-42.

External Inputs

External inputs on the FC6A Series MICROSmart can be switched between and used as normal inputs, high-speed counters, catch inputs, interrupt inputs, and frequency measurements. To use catch inputs, specify the corresponding group as **Catch Input** in the **Function Area Settings** of WindLDR.

The status of external inputs that are assigned to catch inputs are stored in the following special internal relays by group (read-only).

All-in-One CPU module

Group	1		2		3		4		5		6	
External Input	I2	I0	I1	I3	I4	I5	I6	I7				
Catch Input	—*1	Yes	Yes	Yes	Yes	—*1	Yes	Yes				
Special Internal Relay*2	—	M8153	M8154	M8155	M8156	—	M8157	M8160				

*1 Can be used as a normal input.

*2 Read-only.

Plus CPU module

Group	1		2		3		4		5		6	
External Input	I2	I0	I1	I13*2	I3	I4	I5	I6	I7			
Catch Input	—*1	Yes	Yes	—*1	Yes	Yes	—*1	Yes	Yes			
Special Internal Relay*3	—	M8153	M8154	—	M8155	M8156	—	M8157	M8160			

*1 Can be used as a normal input.

*2 Can be used only with the Plus 32-I/O type.

*3 Read-only.

Programming WindLDR

- From the WindLDR menu bar, select **Configuration > Input Configuration**.

The **Function Area Settings** dialog box for Input Configuration appears.

Catch Input Rising/Falling Edge Selection

Catch Input Rising Edge
Catch Input Falling Edge

5: FUNCTIONS AND SETTINGS

2. Select **Catch Input** in the Groups 1 through 4 pull-down list boxes. The Catch Input dialog box appears.
3. Select **Catch Input Rising Edge** or **Catch Input Falling Edge** in the pull-down list.

Catching Rising Edge of Input Pulse

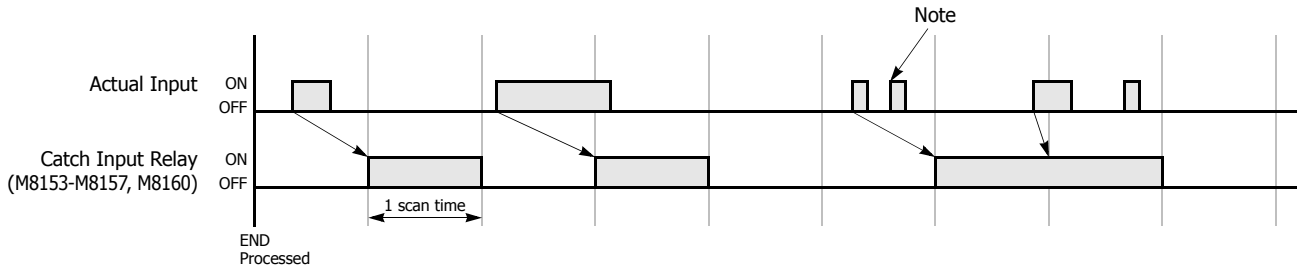

Catching Falling Edge of Input Pulse

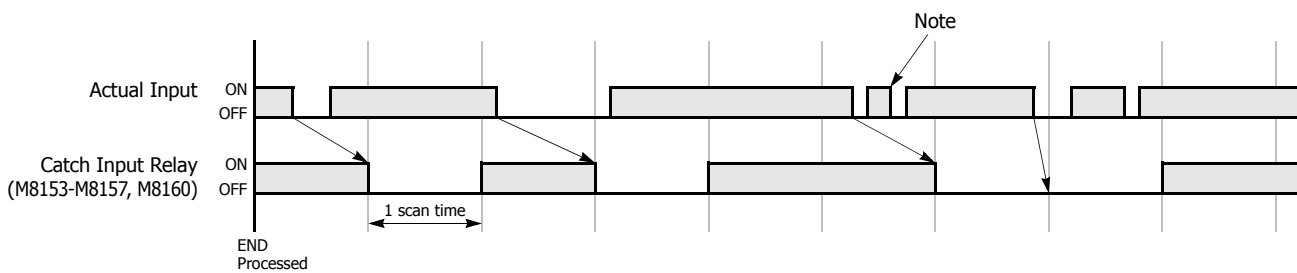

Note: When two or more pulses enter within one scan, subsequent pulses are ignored.

Example: Maintaining Catch Input

When a catch input is received, the catch input relay assigned to a catch input is turned on for only one scan. This example demonstrates a program to maintain a catch input status for more than one scan.

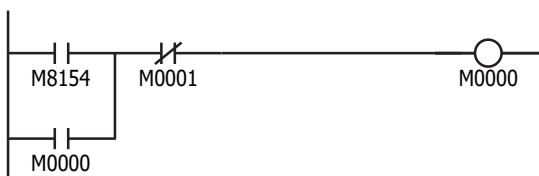

Input I1 is designated as a catch input using the Function Area Settings.

When input I1 is turned on, special internal relay M8154 is turned on, and M0000 is maintained in the self-holding circuit.

When NC input M0001 is turned off, the self-holding circuit is unlatched, and M0000 is turned off.

M0000 is used as an input condition for the subsequent program instructions.

Interrupt Input

When a quick response to an external input is required, such as positioning control, the interrupt input can call a subroutine to execute an interrupt program.

Six inputs I0, I1, I3, I4, I6, and I7 can be designated to execute interrupt at a rising and/or falling edge of input pulses. When an interrupt is initiated by inputs I0, I1, I3, I4, I6 and I7, program execution immediately jumps to a predetermined label number stored in special data registers D8215, D8032 through D8035, and D8214 respectively. The **Function Area Settings** dialog box is used to designate inputs I0, I1, I3, I4, I6 and I7 as an interrupt input, normal input, high-speed counter input, or catch input. Normal input signals to input terminals are read when the END instruction is executed at the end of a scan.

Since these settings relate to the user program, the user program must be downloaded to the FC6A Series MICROSmart after changing any of these settings.

Interrupt Input Terminals, Special Data Registers, and Special Internal Relays for Interrupt Inputs

All-in-One CPU module

Group	1		2	3	4	5		6
External Input	I2	I0	I1	I3	I4	I5	I6	I7
Interrupt Input	—*1	Yes	Yes	Yes	Yes	—*1	Yes	Yes
Special Data Register (Jump Destination Label No.)	—	D8215	D8032	D8033	D8034	—	D8035	D8214
Special Internal Relay (Interrupt Input Status)	—	M8137	M8140	M8141	M8142	—	M8143	M8167
Special Internal Relay (Interrupt Input Edge)		M8192	M8197	M8193	M8194	—	M8195	M8196

*1 Can be used as a normal input.

Plus CPU module

Group	1		2	3		4	5		6
External Input	I2	I0	I1	I13*2	I3	I4	I5	I6	I7
Interrupt Input	—*1	Yes	Yes	—*1	Yes	Yes	—*1	Yes	Yes
Special Data Register (Jump Destination Label No.)	—	D8215	D8032	—	D8033	D8034	—	D8035	D8214
Special Internal Relay (Interrupt Input Status)	—	M8137	M8140	—	M8141	M8142	—	M8143	M8167
Special Internal Relay (Interrupt Input Edge)	—	M8192	M8197	—	M8193	M8194	—	M8195	M8196

*1 Can be used as a normal input.

*2 Can be used only with the Plus 32-I/O type.

Programming WindLDR

- From the WindLDR menu bar, select **Configuration > Input Configuration**. The **Function Area Settings** dialog box for Input Configuration appears.

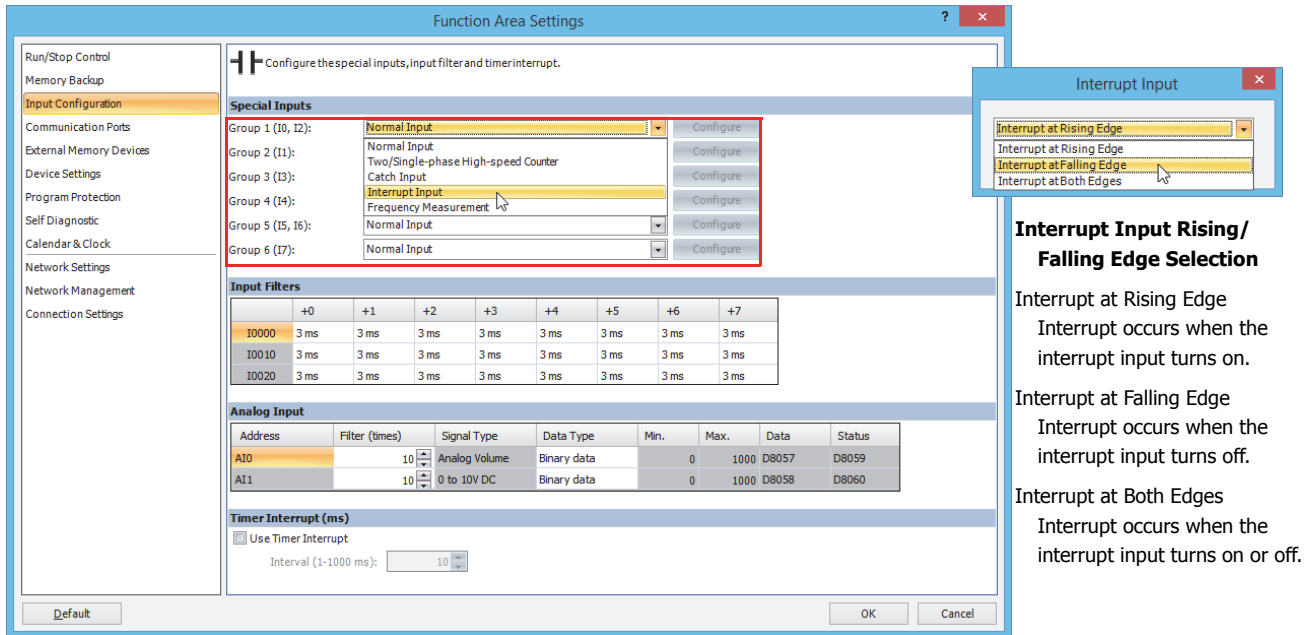

- Select **Interrupt Input** in the Groups 1 through 6 pull-down list boxes. the Interrupt Input dialog box appears.
- Select an interrupt edge in the pull-down list for each group.

Disable and Enable Interrupts

The interrupt inputs I0, I1, I3, I4, I6, and I7 and timer interrupt are normally enabled while the FC6A Series MICROSmart is running, and can also be individually disabled using the DI instruction or enabled using the EI instruction. When interrupt inputs I0, I1, I3, I4, I6, and I7 are enabled, special internal relay M8137 through M8143, and M8167 are turned on, respectively. See Chapter 14 "Refresh Instructions" in the "FC6A Series MICROSmart Ladder Programming Manual".

Example: Interrupt Input

The following example demonstrates a program using the interrupt input function, with input I1 designated as an interrupt input. When the interrupt input is turned on, the input I0 status is immediately transferred to output Q0 using the IOREF (I/O refresh) instruction before the END instruction is executed. For the IOREF instruction, See Chapter 14 "Refresh Instructions" in the "FC6A Series MICROSmart Ladder Programming Manual".

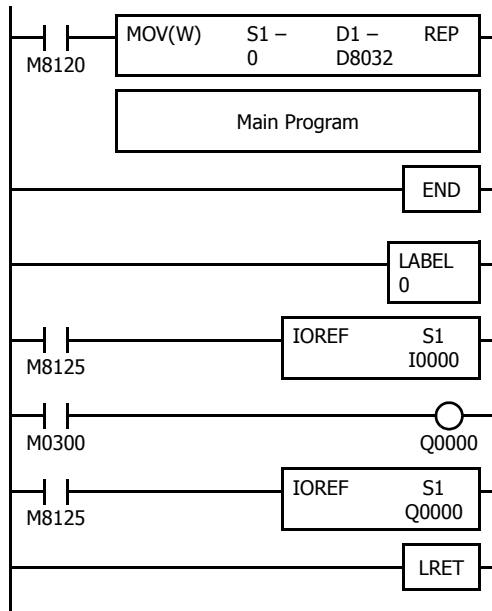

M8120 is the initialize pulse special internal relay.

D8032 stores 0 to designate jump destination label 0 for interrupt input I1.

The interrupt program is separated from the main program by the END instruction.

When input I1 is on, program execution jumps to label 0.

M8125 is the in-operation output special internal relay.

IOREF immediately reads input I0 status to internal relay M0300.

M0300 turns on or off the output Q0 internal memory.

Another IOREF immediately writes the output Q0 internal memory status to actual output Q0.

Program execution returns to the main program.

Insert LRET at the end of the subroutine to return to the main program.

Notes for Using Interrupt Inputs and Timer Interrupt:

- When using an interrupt input or timer interrupt, separate the interrupt program from the main program using the END instruction at the end of the main program.
- When an interrupt program calls another subroutine, a maximum of 3 subroutine calls can be nested. If more than 3 calls are nested, a user program execution error occurs, turning on special internal relay M8004 and the ERR LED.
- When using an interrupt input or timer interrupt, include the label number of the interrupt program to be executed when an interrupt occurs. The label numbers stored in data registers D8214, D8215, and D8032 through D8035 specify the interrupt programs for interrupt inputs I0, I1, I3, I4, I6, and I7 and timer interrupt, respectively.
- When more than one interrupt input is turned on at the same time, interrupt program execution is given priority to inputs I0, I1, I3, I4, I6, and I7, in that order. If an interrupt is initiated while another interrupt program is executed, the subsequent interrupt program is executed after the prior interrupt is completed. Multiple interrupt programs cannot be executed simultaneously.
- Make sure that the execution time of the interrupt program is shorter than interrupt intervals sufficiently.
- Interrupt programs cannot use the following instructions: SOTU, SOTD, TML, TIM, TMH, TMS, TMLO, TIMO, TMHO, TMSO, CNT, CDP, CUD, CNTD, CDPD, CUDD, SFR, SFRN, WKTIM, WJTBL, WEEK, YEAR, MSG, DISP, DGRD, COMRF, DI, EI, XYFS, CVXTY, CVYTX, AVRG, PULS, PWM, RAMP, ZRN, ARAMP, ABS, JOG, PID, PIDA, DTML, DTIM, DTMH, DTMS, TTIM, FIFO, NDSRC, HOUR, SCALE, FLWA, FLWP, PING, EMAIL, TXD, RXD, ETXD, ERXD, DLOG, and TRACE.

Frequency Measurement

This section describes frequency measurement, which measures the frequency of pulses input to an external input. Frequency measurement is a function that measures the frequency of pulses input to an external input.

These input pulses are processed with dedicated hardware device in FC6A Series MICROSmart, so frequencies can be measured with no relation to the scan time. The measurement results are stored in special data registers and they are updated with each scan.

Function Specification

The FC6A Series MICROSmart external inputs are used by switching between normal input, high-speed counters, catch input, interrupt input, and frequency measurement. To use frequency measurement, specify the relevant group as **Frequency Measurement** in the WindLDR **Function Area Settings**.

Frequency measurement can be used with the following external inputs.

The frequency measurement results are stored in the following special data registers for each external input group.

All-in-One CPU module

Group	1		2	3	4	5		6	
External Input	I2	I0	I1	I3	I4	I5	I6	I7	
Frequency Measurement Value	—*1	Yes	Yes	Yes	Yes	—*1	Yes	Yes	
Frequency Measurement Range	4 Hz to 100 kHz			4 Hz to 5 kHz		4 Hz to 100 kHz			
Measurement Error	Less than ±10% (4 Hz or higher and less than 4 kHz), less than ±0.1% (4 kHz or higher)								
Calculation Cycle	Within 1 s (less than 4 kHz), within 250 ms (4 kHz or higher)								
Frequency Measurement Value (32 bits)	Upper Word	—	D8210	D8192	D8218	D8222	—	D8226	D8198
	Lower Word	—	D8211	D8193	D8219	D8223	—	D8227	D8199

*1 Can be used as a normal input.

Plus CPU module

Group	1		2	3		4	5		6	
External Input	I2	I0	I1	I13*2	I3	I4	I5	I6	I7	
Frequency Measurement Value	—*1	Yes	Yes	—*1	Yes	Yes	—*1	Yes	Yes	
Frequency Measurement Range	4 Hz to 100 kHz									
Measurement Error	Less than ±10% (4 Hz or higher and less than 4 kHz), less than ±0.1% (4 kHz or higher)									
Calculation Cycle	Within 1 s (less than 4 kHz), within 250 ms (4 kHz or higher)									
Frequency Measurement Value (32 bits)	Upper Word	—	D8210	D8192	—	D8218	D8222	—	D8226	D8198
	Lower Word	—	D8211	D8193	—	D8219	D8223	—	D8227	D8199

*1 Can be used as a normal input.

*2 Can be used only with the Plus 32-I/O type.

Notes:

- R/W is the abbreviation for read/write. When R/W, it can be read and written. When R, it can only be read. When W, it can only be written.
- To reflect the measurement results in the special data registers, a maximum of calculation cycle + scan time is required. However, when the FRQRF instruction is used during ladder processing, the frequency value of the special data registers can be updated to the latest value. The latest calculation result can be read within 250 ms regardless of the input frequency.
- The data registers for the upper word and the lower word of the measurement value change according to the 32-bit data storage method specified. For details, see "32-bit Data Storage Setting" on page 5-56.

Programming WindLDR

To use frequency measurement, you must configure the **Function Area Settings** in WindLDR and download the user program to the FC6A Series MICROSmart. Frequency measurements will start when you download the user program and set the FC6A Series MICROSmart to run.

1. From the WindLDR menu bar, select **Configuration > Input Configuration**.
The **Function Area Settings** dialog box is displayed.
2. Specify **Frequency Measurement** for the group to use frequency measurement.

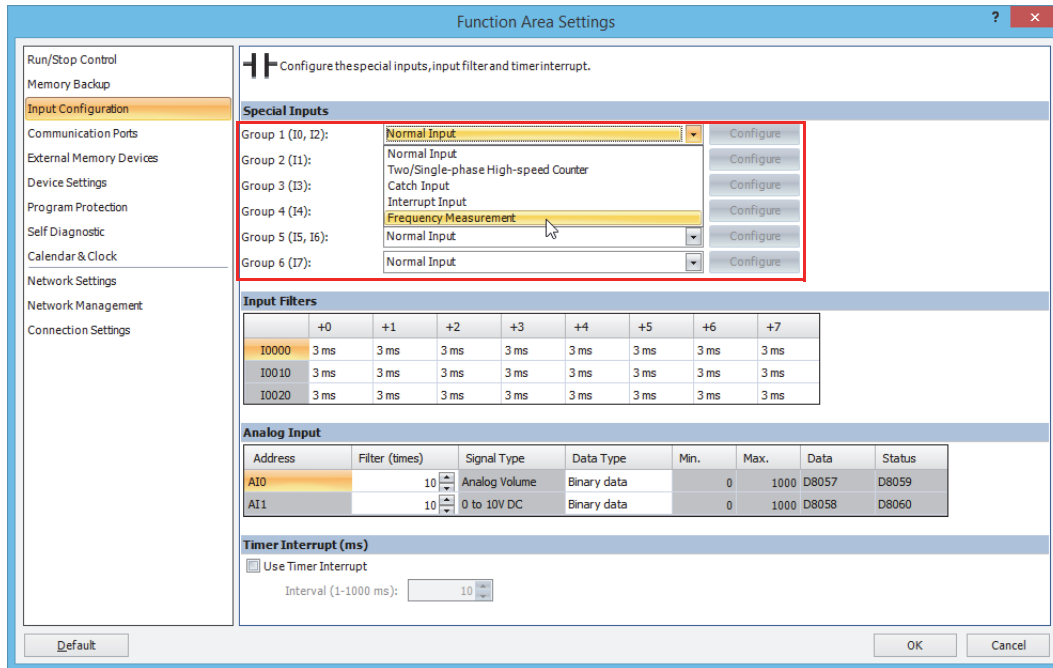

3. Click **OK**.
This concludes configuring the settings.

Input Filter

The input filter function is used to reject input noises. The catch input function described in the preceding section is used to read short input pulses to special internal relays. To the contrary, the input filter rejects short input pulses when the FC6A Series MICROSmart is used with input signals containing noises.

Different input filter values can be selected for inputs I0 through I27 in four groups using the **Function Area Settings**. Selectable input filter values to pass input signals are 0 ms, and 3 through 15 ms in 1 ms increments. Default value is 3 ms for all inputs I0 through I27. Input I30 and above on all expansion input modules have a fixed filter of 3 ms. The input filter rejects inputs shorter than the selected input filter value minus 2 ms.

Normal inputs require a pulse width of the filter value plus one scan time to receive input signals. When using the input filter function, select **Normal Input** under Special Inputs on the Input Configuration dialog box in the **Function Area Settings**. Since these settings relate to the user program, the user program must be downloaded to the FC6A Series MICROSmart after changing any of these settings.

Programming WindLDR

- From the WindLDR menu bar, select **Configuration > Input Configuration**. The **Function Area Settings** dialog box for Input Configuration appears.

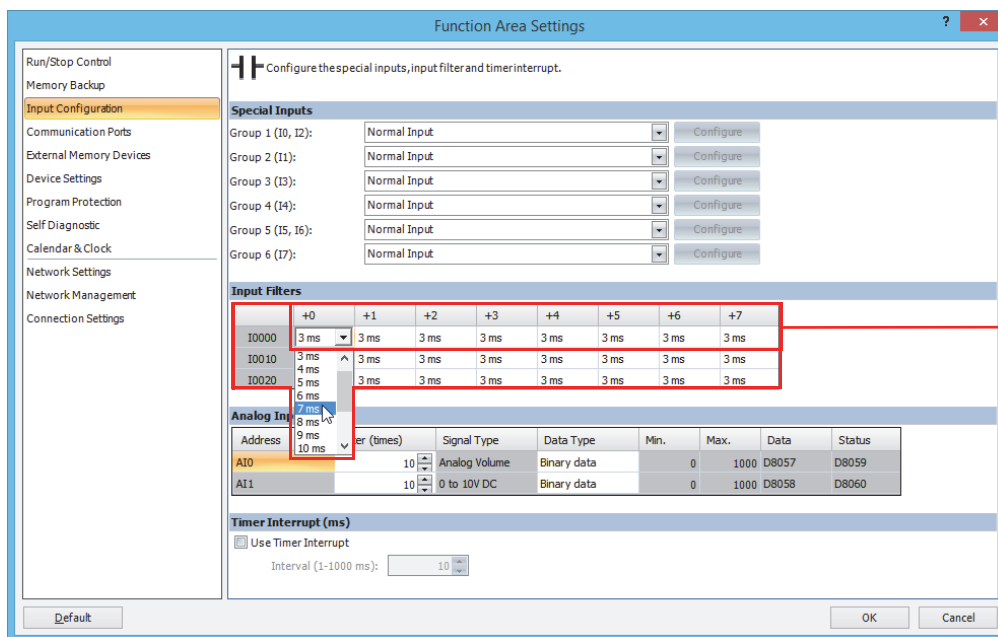

The columns displayed next to I0 indicate I0 to I7.

- Select an input filter value for each group of inputs.

Input Filter Values and Input Operation

Depending on the selected values, the input filter has three response areas to reject or pass input signals.

- Reject area:** Input signals do not pass the filter (selected filter value minus 2 ms).
- Indefinite area:** Input signals may be rejected or passed.
- Pass area:** Input signals pass the filter (selected filter value).

Example: Input Filter 8 ms

To reject input pulses of 6 ms or less, select input filter value of 8 ms. Then input pulses of 8 ms plus one scan time are accepted correctly at the END processing.

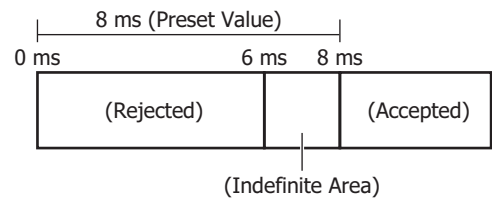

When there is a change in the input, the input filter starts measuring the time. Once the measured time exceeds the preset value, the change in the input is acquired internally.

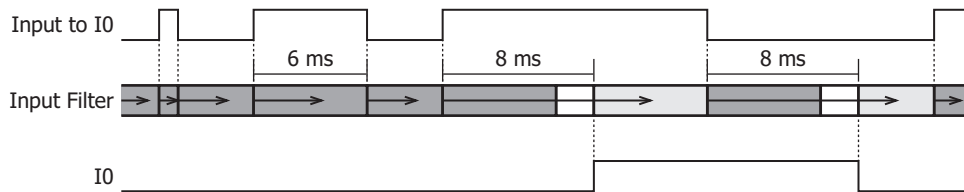

Notes:

- Signals that pass through the input filter cannot always be acquired as input. To acquire a signal as normal input, a maximum pulse width of input filter value + 1 scan time is required.
- When an external input (I0, I2, I3, I5, I6, I7) is set to a high-speed counter, catch input, interrupt input, frequency measurement, or the interrupt input for an ARAMP instruction or a ZRN instruction, the input filter is disabled.
- The filter for I/O module external inputs (starting from I30) are fixed at 3 ms. This filter value cannot be changed.

Analog Voltage Input

The section describes the analog input built into the FC6A Series MICROSmart.

Function Description

The FC6A Series MICROSmart is equipped with a built-in analog voltage input function. This function acquires 0 to 10V DC voltage analog input by converting it to a digital value. The converted analog signal is stored in a special data register. Only one analog input can be used.

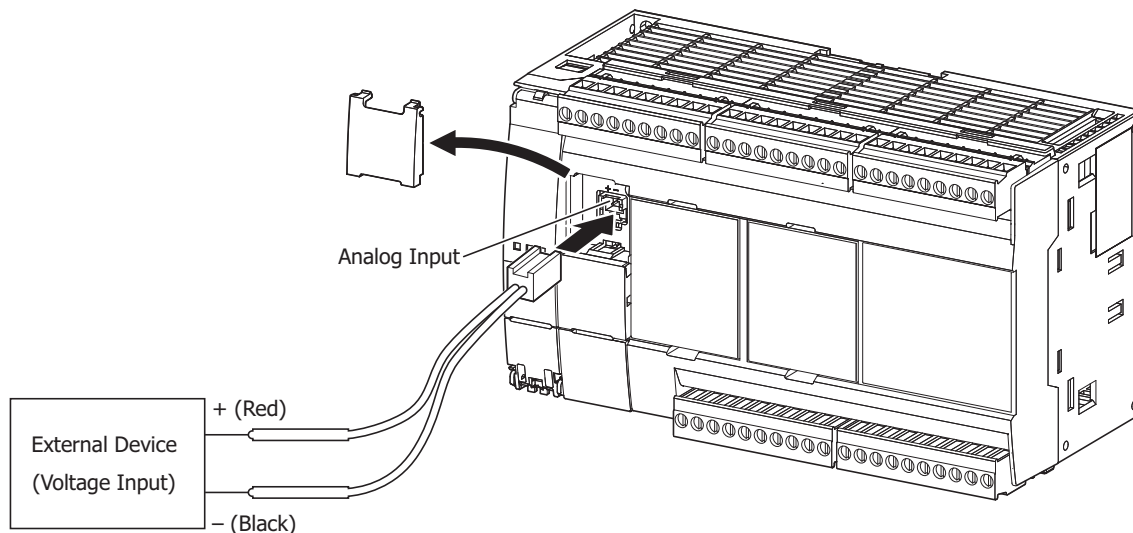

Analog input value storage location

The converted analog signal is stored in a special data register (D8058: read-only) as a digital value. This digital value is updated with each scan. The range of the value that is stored in the special data register (D8058: read-only) can be specified with the data type.

Analog input status (D8060)

The analog input status code is stored in special data register D8060 (analog input status).

Status code	Details	Analog Input Value
0	Normal operation	Current analog input value
1	Converting data (occurs only once during the initial conversion when the power is turned on)	Undefined
2	Initializing	0
5	Wiring fault (out of maximum range) When the analog input value exceeds 11 V	Upper limit value
3, 4, 6 to 65,535	Reserved	—

Analog Input Filter

The analog input data is averaged by the specified filter count. This can reduce rapid fluctuations in analog input.

The larger this value is set, the slower the tracking of the change in analog input becomes.

Count	Details
1 to 255	The input value is set as the average value of n samples of analog input data. (n: Count)

When filtering, the input value is calculated with the equation below.

$$\text{Analog input value after filtering} = \frac{\text{Total analog input values for filter count (n) worth of scans}}{\text{Filter count n}}$$

Analog input data types

The range of analog values that can be handled with the specified data types are as follows.

Data type	Details	
	All-in-One CPU Module	Plus CPU Module
Binary data	0 to 1,000	0 to 4,000
Optional range	Minimum to maximum (The minimum and maximum in a range between 0 to 1,000 where minimum ≤ maximum)	Minimum to maximum (The minimum and maximum in a range between -32,768 to 32,767 where minimum ≤ maximum)

Programming WindLDR

To use analog input, you must configure the **Function Area Settings** in WindLDR and download the user program to the FC6A Series MICROSmart.

1. On the **Configuration** tab, in the **Function Area Settings** group, click **Input Configuration**. The **Function Area Settings** dialog box is displayed.
2. For AI1, configure the filter count and data type for the analog input. The AI1 signal type is fixed as "0 to 10V DC".

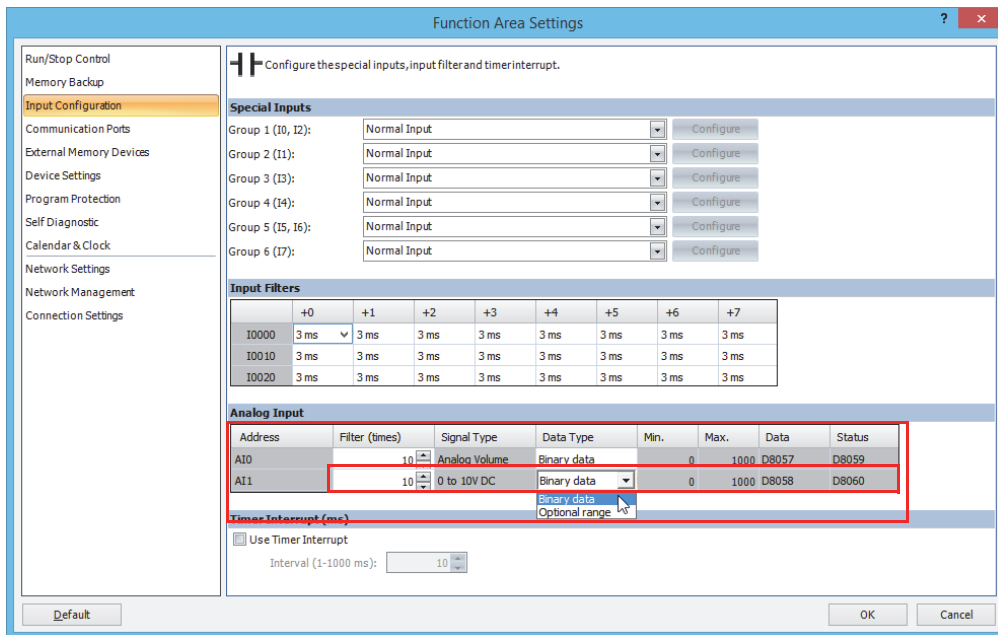

3. Click **OK**.

This concludes configuring the settings.

Analog Potentiometer

This section describes the analog potentiometer that changes the analog value used in the user program without the use of an external device.

Function Description

The analog potentiometer has a minimum value of 0 and a maximum value of 1,000. An analog value of 0 to 1,000 is acquired according to the position of the analog potentiometer and without the use of any special external devices, and that value is stored in a special data register.

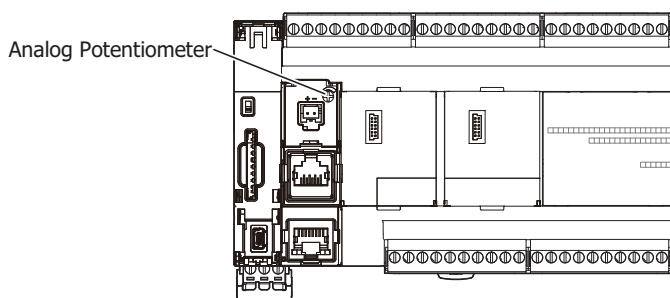

Analog potentiometer value storage location

The analog potentiometer value is stored in a special data register (D8057: read-only) as a value between 0 and 1,000. This value is updated with each scan.

Analog potentiometer status (D8059)

The analog potentiometer status code is stored in special data register D8059 (analog potentiometer status).

Status code	Details	Analog Potentiometer Value
0	Normal operation	Current analog potentiometer value
1	Converting data (occurs only once during the initial conversion when the power is turned on)	Undefined
2	Initializing	0
3 to 65,535	Reserved	—

Analog Potentiometer Filter

The analog potentiometer data is averaged by the specified filter count. This can reduce rapid fluctuations in the analog potentiometer.

The larger this value is set, the slower the tracking of the change in analog potentiometer becomes.

Count	Details
0	No filtering
1 to 255	The input value is set as the average value of n samples of analog potentiometer data. (n: Count)

When filtering, the input value is calculated with the equation below.

$$\text{Analog potentiometer value after filtering} = \frac{\text{Total analog potentiometer values for filter count (n) worth of scans}}{\text{Filter count n}}$$

Analog potentiometer data types

The range of analog potentiometer values that can be handled with the specified data types are as follows.

Data type	Details
Binary data	0 to 1,000
Optional range	Minimum to maximum (The minimum and maximum in a range between 0 to 1,000 where minimum ≤ maximum)

Programming WindLDR

To use the analog potentiometer, you must configure the **Function Area Settings** in WindLDR and download the user program to the FC6A Series MICROSmart.

1. On the **Configuration** tab, in the **Function Area Settings** group, click **Input Configuration**. The **Function Area Settings** dialog box is displayed.
2. For AI0, configure the filter count and data type for the analog Potentiometer. The AI0 signal type is fixed as "Analog Potentiometer".

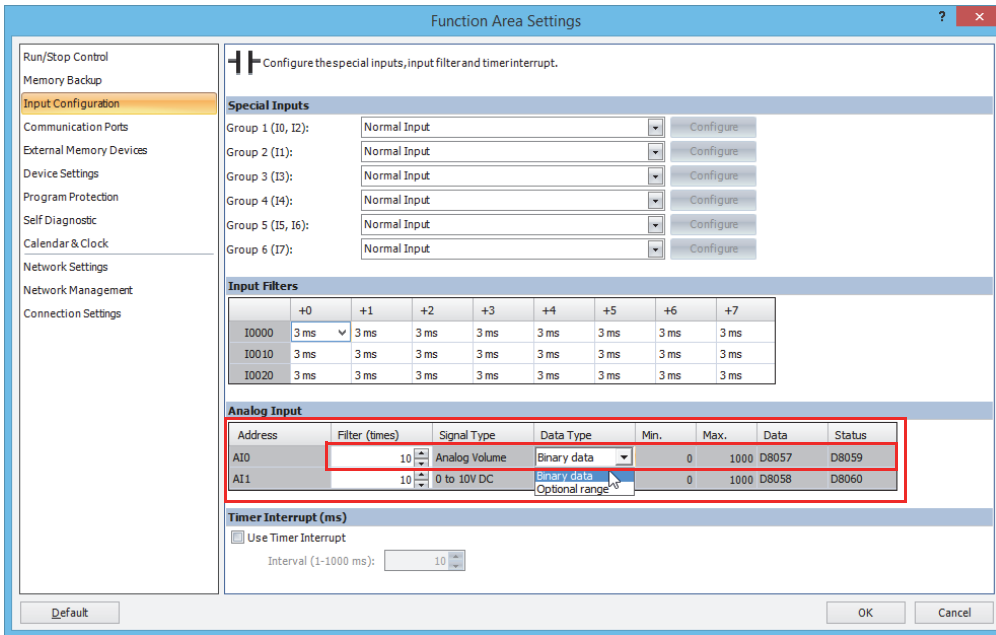

3. Click **OK**.

This concludes configuring the settings.

Example program

This program uses the analog potentiometer value for the counter preset value.

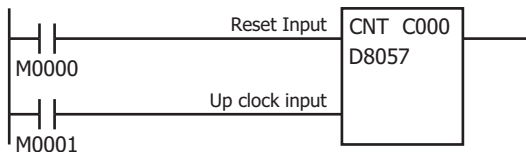

When reset input M0000 turns on, the current value is reset to "0".
 While reset input M0000 is off, the counter can count.
 While the counter is in the state where it can count, it increments +1 with each rise in up clock input M0001.
 When the current value reaches analog potentiometer value D8057, counting ends, and the counter output is maintained until reset input M0000 is turned on.

Timer Interrupt

In addition to the interrupt input as described in the preceding section, all FC6A Series MICROSmart have a timer interrupt function. When a repetitive operation is required, the timer interrupt can be used to call a subroutine repeatedly at predetermined intervals of 1 through 1,000 ms.

The **Function Area Settings** dialog box is used to enable the timer interrupt and to specify the interval, from 1 to 140 ms, to execute the timer interrupt. When the timer interrupt is enabled, the program execution repeatedly jumps to the jump destination label number stored in special data register D8036, while the FC6A Series MICROSmart is running. When the interrupt program is completed, the program execution returns to the main program at the address where the interrupt occurred.

Since these settings relate to the user program, the user program must be downloaded to the FC6A Series MICROSmart after changing any of these settings.

Special Data Register and Special Internal Relay for Timer Interrupt

Interrupt	Special Data Register for Timer Interrupt Jump Destination Label No.	Special Internal Relay for Timer Interrupt Status
Timer Interrupt	D8036	M8144

Note: A label is the starting address of the program branch to jump to, and it is specified by the LABEL instruction.

Programming WindLDR

- From the WindLDR menu bar, select **Configuration > Input Configuration**. The **Function Area Settings** dialog box for Input Configuration appears.

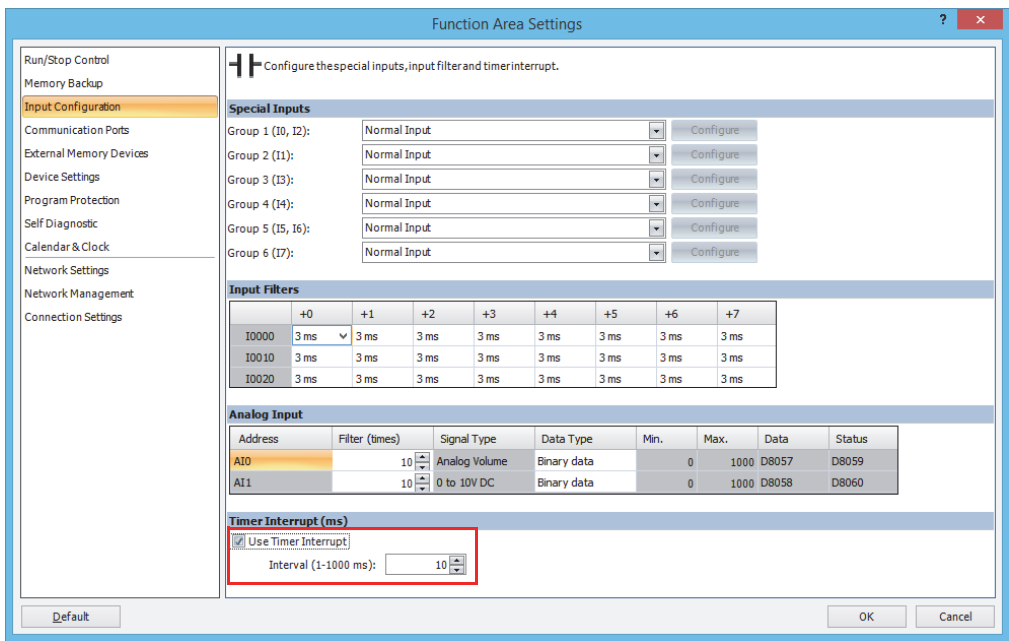

- Under the Timer Interrupt, click the check box to use the timer interrupt function.
- Select an interval to execute the timer interrupt, from 1 to 140 ms.
- Click **OK**.

This concludes configuring the settings.

Disable and Enable Interrupts

The timer interrupt and interrupt inputs I0, I1, I3, I4, I6 and I7 are normally enabled while the FC6A Series MICROSmart is running, and can also be individually disabled using the DI instruction or enabled using the EI instruction. When timer interrupt is enabled, M8144 is turned on. When disabled, M8144 is turned off. See Chapter 15 "Interrupt Control Instructions" in the "FC6A Series MICROSmart Ladder Programming Manual".

Example: Timer Interrupt

The following example demonstrates a program of using the timer interrupt function. The Function Area Settings must also be completed to use the timer interrupt function as described on the preceding page.

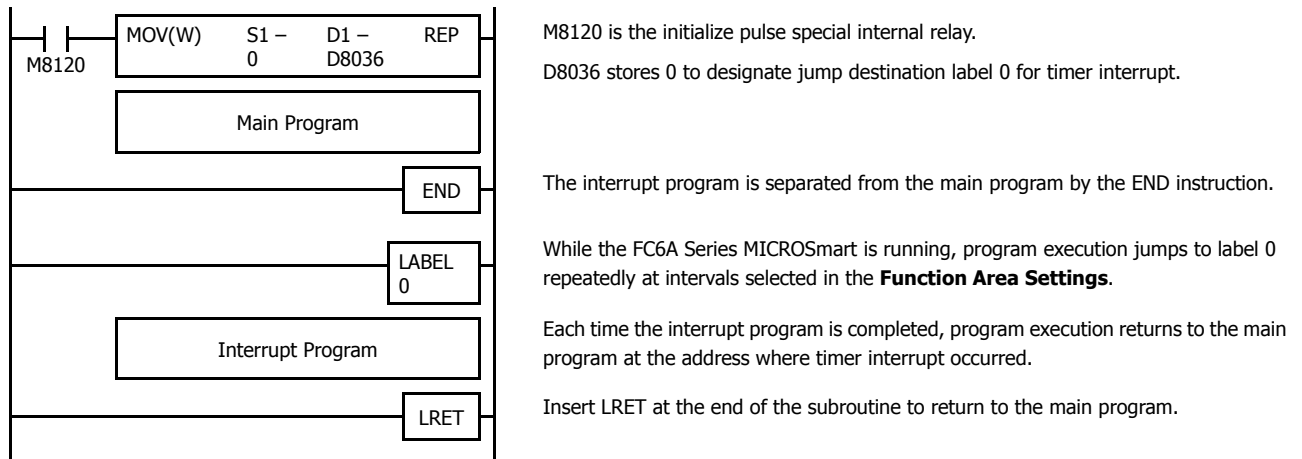

Notes for Using Timer Interrupt and Interrupt Inputs:

- When using a timer interrupt or interrupt input, separate the interrupt program from the main program using the END instruction at the end of the main program.
- When an interrupt program calls another subroutine, a maximum of 3 subroutine calls can be nested. If more than 3 calls are nested, a user program execution error occurs, turning on special internal relay M8004 and the ERR LED.
- When using a timer interrupt or interrupt input, include the label number of the interrupt program to be executed when an interrupt occurs. The label numbers stored in data registers D8214, D8215, D8032 through D8035 specify the interrupt programs for interrupt inputs I0, I1, I3, I4, I6 and I7 and timer interrupt, respectively.
- If an interrupt is initiated while another interrupt program is executed, the subsequent interrupt program is executed after the prior interrupt is completed. Multiple interrupt programs cannot be executed simultaneously.
- Make sure that the execution time of the interrupt program is shorter than interrupt intervals sufficiently.
- Interrupt programs cannot use the following instructions: SOTU, SOTD, TML, TIM, TMH, TMS, TMLO, TIMO, TMHO, TMSO, CNT, CDP, CUD, CNTD, CDPD, CUDD, SFR, SFRN, WKTIM, WKTBL, WEEK, YEAR, MSG, DISP, DGRD, COMRF, DI, EI, XYFS, CVXTY, CVYTX, AVRG, PULS, PWM, RAMP, ZRN, ARAMP, ABS, JOG, PID, PIDA, DTML, DTIM, DTMH, DTMS, TTIM, FIFO, NDSRC, HOUR, SCALE, FLWA, FLWP, PING, EMAIL, TXD, RXD, ETXD, ERXD, DLOG, TRACE, and SCRPT.

Forced I/O Function

Inputs can be forced on/off regardless of the status of physical inputs, and outputs can be forced on/off regardless of the ladder logic using the forced I/O function in WindLDR. The force input function can be used to monitor or online edit mode to test the ladder logic without the need of wiring the input terminals or turning on the actual inputs. The force output function can be used to turn on/off the outputs to the external devices.

	Caution The forced I/O may cause unexpected operation of the FC6A Series MICROSmart. Make sure of safety before forcing inputs or outputs.
---	---

Devices

All the inputs and outputs of the FC6A Series MICROSmart can be forced on/off individually.

All-in-One CPU module

Type	Device Range	
	Inputs	Outputs
16-I/O type	I0 to I10, I30 to I627, I630 to I633	Q0 to Q6, Q30 to Q627, Q630 to Q633
24-I/O type	I0 to I15, I30 to I627, I630 to I633	Q0 to Q11, Q30 to Q627, Q630 to Q633
40-I/O type	I0 to I27, I30 to I627, I630 to I637	Q0 to Q617, Q30 to Q627, Q630 to Q637

Plus CPU module

Type	Device Range	
	Inputs	Outputs
Plus 16-I/O type	I0 to I7, I30 to I627, I630 to I643, I1000 to I1597, I2000 to I2597, I3000 to I3597, I4000 to I4597, I5000 to I5597, I6000 to I6597, I7000 to I7597, I8000 to I8597, I9000 to I9597, I10000 to I10597	Q0 to Q7, Q30 to Q627, Q630 to Q643, Q1000 to Q1597, Q2000 to Q2597, Q3000 to Q3597, Q4000 to Q4597, Q5000 to Q5597, Q6000 to Q6597, Q7000 to Q7597, Q8000 to Q8597, Q9000 to Q9597, Q10000 to Q10597
Plus 32-I/O type	I0 to I17, I30 to I627, I630 to I643, I1000 to I1597, I2000 to I2597, I3000 to I3597, I4000 to I4597, I5000 to I5597, I6000 to I6597, I7000 to I7597, I8000 to I8597, I9000 to I9597, I10000 to I10597	Q0 to Q17, Q30 to Q627, Q630 to Q643, Q1000 to Q1597, Q2000 to Q2597, Q3000 to Q3597, Q4000 to Q4597, Q5000 to Q5597, Q6000 to Q6597, Q7000 to Q7597, Q8000 to Q8597, Q9000 to Q9597, Q10000 to Q10597

Forced I/O Status

Events of the FC6A Series MICROSmart and effects on the forced I/O settings are shown below.

Events	Forced I/O Status
When the FC6A Series MICROSmart starts running	The force settings are retained. The forced inputs and outputs are kept on/off even after the FC6A Series MICROSmart is stopped, regardless of the status of M8025 (maintain outputs while FC6A Series MICROSmart is stopped).
When the FC6A Series MICROSmart is stopped.	
When the FC6A Series MICROSmart is powered up	The force settings are retained, but the force is suspended. If the battery is dead, the force settings are cleared.
When user program download is executed	The force settings are retained, and whether the force will be suspended or not can be selected in the Download Program dialog box.
When Reset Input is turned on	
When Clear All Devices is executed in the PLC Status dialog box of WindLDR	
When the system software download is executed	
	The force settings are cleared.

Note: Force function has no effect on high-speed counters, catch inputs, or interrupt inputs. The stop or reset input can be initiated using the force function, but the force settings will be cleared as soon as the reset input is turned on.

Checking Forced I/O Function Execution State

The forced I/O function status (running or stopped) can be checked with WindLDR or with the FC6A Series MICROSmart run LED [RUN]. Details on the run LED [RUN] that shows the forced I/O function status are as follows.

LED	Status
ON	When the forced I/O function is stopped while the CPU module is running the user program
Slow flashing (1 s cycle)	When executing the forced I/O function while the user program is running
Quick flashing (100 ms cycle)	When executing the forced I/O function while the user program is stopped

Forced I/O List

The forced I/O function is controlled with the Force I/O List in WindLDR.

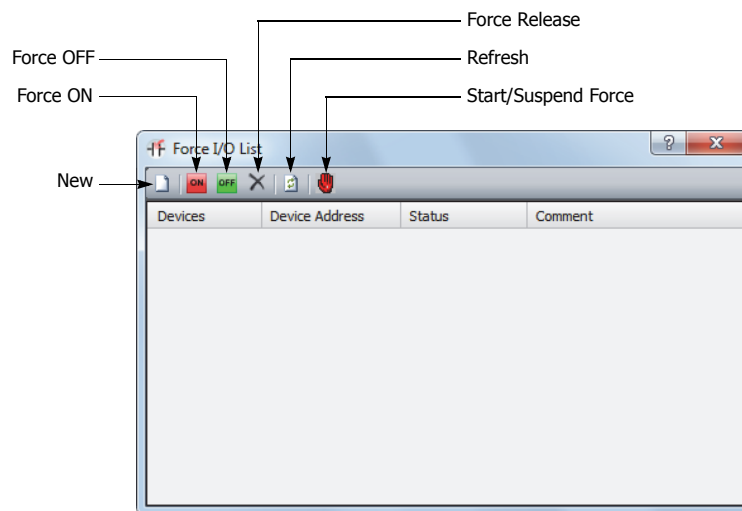

- (1) **New**
Register an I/O device to the list that will be set for forced I/O.
- (2) **Force On**
Switches the status to on.
- (3) **Force Off**
Switches the status to off.
- (4) **Force Release**
Cancels the status of the I/O device set for forced I/O.
- (5) **Refresh**
Updates the list.
- (6) **Start/Suspend Force**
Starts and stops the forced I/O function.

Programming WindLDR

1. From the WindLDR menu bar, select **Online > Monitor > Monitor**.
Online mode is activated.
2. From the WindLDR menu bar, select **Online > Forced I/O**.
The Forced I/O List dialog box appears and shows a list of forced inputs and outputs. I/O numbers and force I/O statuses can be specified in this dialog box.

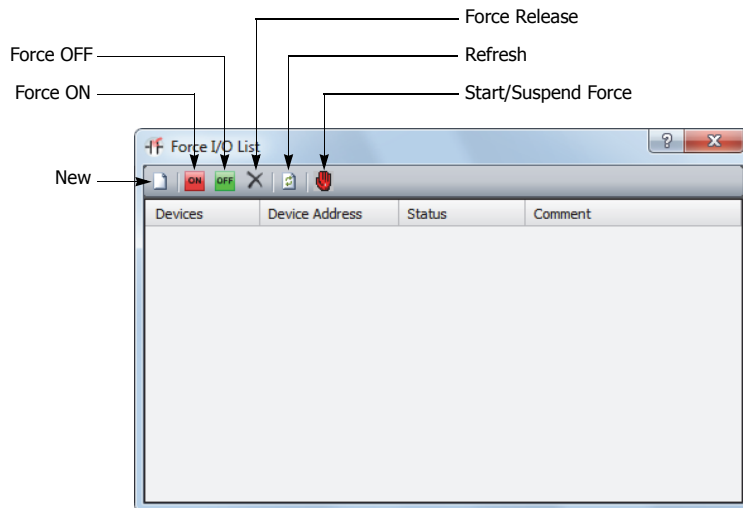

3. Click the New button and type an input or output number under Device in the list. Click the Force On button or Force Off button to force on or off the designated input or output.

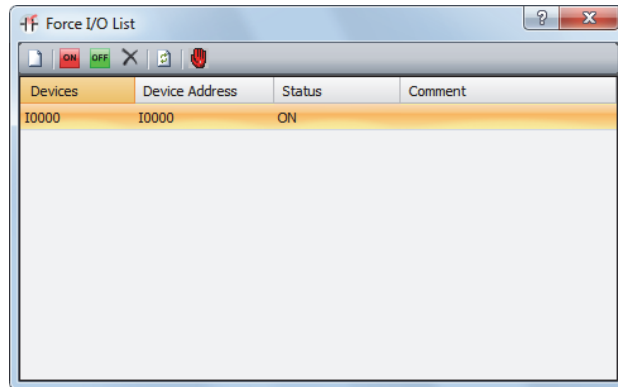

4. To start the forced I/O function, click the Start/Suspend Force button .

A sign is displayed to show input I0 is forced.



The forced I/O can be suspended temporarily by clicking the Start/Suspend Force button again.

5. To suspend the forced I/O, click the Start/Suspend Force button .

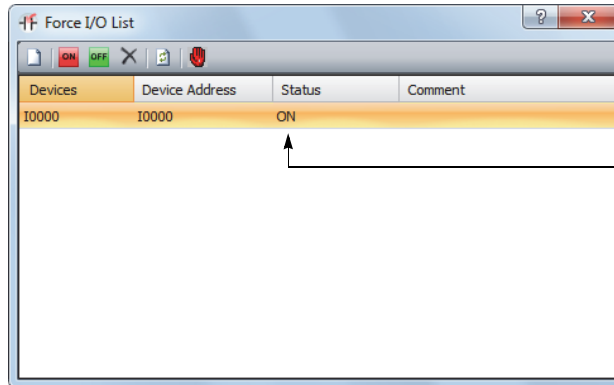

Even though I0 is designated, forced I/O is suspended and actual input status is read to the FC6A Series MICROSmart.

The forced inputs or outputs remain designated until the forced I/O designation is released.

6. To release the forced I/O designation, click the Force Release button .

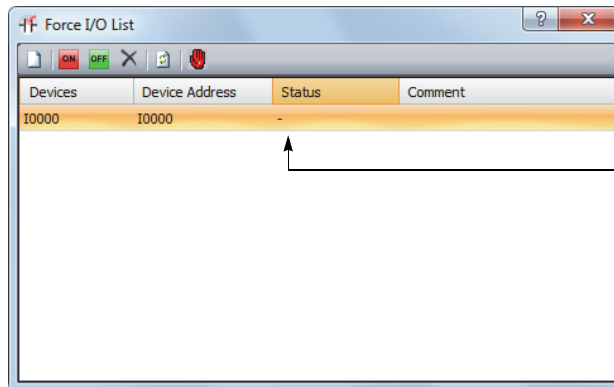

Input I0 is released from the forced I/O designation. Even when forced I/O is enabled, actual input status is read to the FC6A Series MICROSmart.

Now input I0 works as a normal input.

Note: Make sure that all the forced inputs and outputs are released when the test using the forced I/O function is finished. Select **Delete All** from the right click menu in the Forced I/O List dialog box to release all the forced inputs and outputs at once.

External Memory Devices

This section describes the CSV file format of log data that is saved to the SD memory card.

Function Description

Specify the CSV file format when saving specific device values as log data (CSV file) using the DLOG (data log) instruction and the TRACE (data trace) instruction.

For **Decimal Symbol**, select either **Period (.)** or **Comma (,)**.

Separating Character is determined by the symbol that is selected for **Decimal Symbol**.

Decimal Symbol	Separating Character
Period (.)	Comma (,)
Comma (,)	Semicolon (:)

Programming WindLDR

1. From the WindLDR menu bar, select **Configuration > External Memory Devices**.
The **Function Area Settings** dialog box appears.
2. Under **CSV File Format**, select the symbols for **Decimal Symbol**.

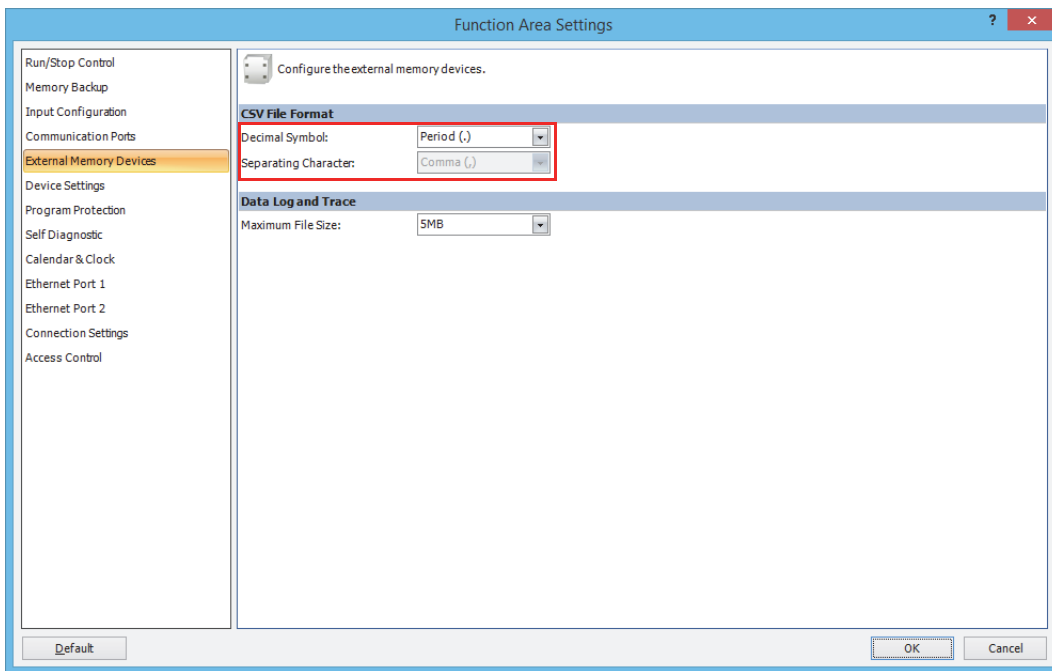

3. Click **OK**.

This concludes configuring the settings.

Log Data File Size

This section provides an explanation of the maximum file size for log data that is saved to the SD memory card.

Function Description

Set the maximum file size for when saving specific device values to the SD memory card as log data (CSV file) using the DLOG (data log) instruction and the TRACE (data trace) instruction.

This value can be selected from 10 KB, 20 KB, 50 KB, 100 KB, 200 KB, 500 KB, 1 MB to 10 MB (in increments of 1 MB), or 256 MB. The default is 5 MB.

Notes:

- If the file size exceeds the maximum when saving the log data in basic mode of the DLOG instruction or with the TRACE instruction, the file is saved with "_" + "2 digit number (01 to 99)" appended to the file name.
Example: 20170401_01.csv
- The file size is not checked while the log data is being saved, so log data will be saved to the same file, even if it exceeds the log data file size. The maximum file size is the log data file size + 1,024 bytes (maximum value of one entry of log data).

Programming WindLDR

1. On the **Configuration** tab, in the **Function Area Settings** group, click **External Memory Devices**. The **Function Area Settings** dialog box is displayed.
2. Under **Data Log and Trace**, select the maximum file size (10 KB, 20 KB, 50 KB, 100 KB, 200 KB, 500 KB, 1 MB to 10 MB, 256 MB).

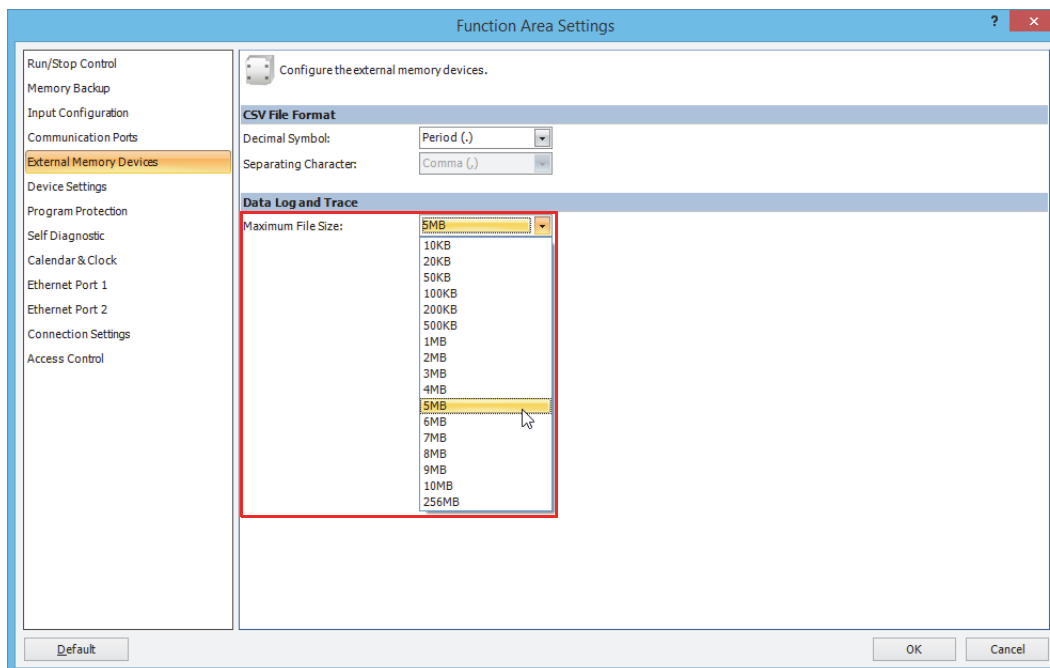

3. Click **OK**.

This concludes configuring the settings.

32-bit Data Storage Setting

This section describes the methods of storing 32-bit data in data registers.

Function Specification

When the double-word, long, or float data type is selected for the source or destination device, the data is loaded from or stored to two consecutive data registers. The order of the two devices can be selected from the following two settings in the **Function Area Settings**.

Setting	Description
From Upper Word (Default)	When a data register, timer, or counter is used as a double-word device, the high-word data is loaded from or stored to the first device selected. The low-word data is loaded from or stored to the subsequent device. This is identical with the 32-bit data storage of OpenNet Controller and FC4A/FC5A MICROSmart.
From Lower Word	When a data register, timer, or counter is used as a double-word device, the low-word data is loaded from or stored to the first device selected. The high-word data is loaded from or stored to the subsequent device.

Devices

When the devices listed below are used as a double-word device, two consecutive devices are processed according to the 32-bit data storage settings.

Device	Device Address
Data Register	D0 - D7999, D10000 - D61999
Special Data Register	D8000 - D8899
Non-retentive Data Register	D70000 - D269999
Counter	C0 - C511

Data: The following data composed of 32 bits is subject to this setting.

- Device values of advanced instructions with the data processing units D (double word), L (long), F (float)
- Pulse output preset values and current values
- High-speed counter function current values, preset values, and reset values
- Frequency measurement values in frequency measurement
- Double word counter instruction preset values

Programming WindLDR

1. From the WindLDR menu bar, select **Configuration > Device Settings**. The **Function Area Settings** dialog box for Device Settings appears.

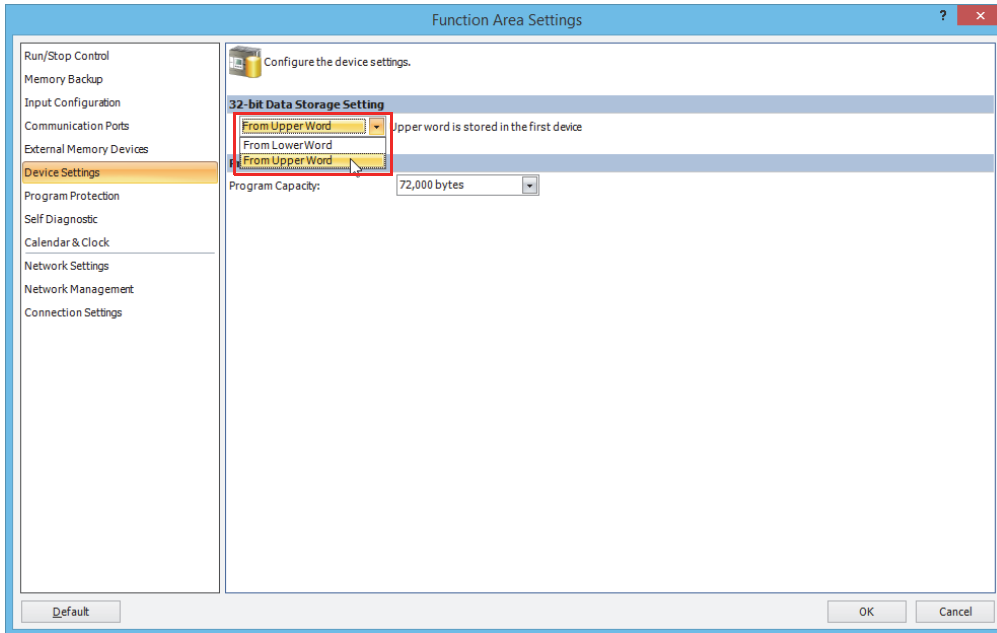

2. Under **32-bit Data Storage Setting**, select **From Upper Word** or **From Lower Word** in the pull-down list.

Example: 32-bit Data Storage Setting

When data register D10 is designated as a double-word source device and data register D20 is designated as a double word destination device, the data is loaded from or stored to two consecutive devices according the 32-bit data storage setting as illustrated below.

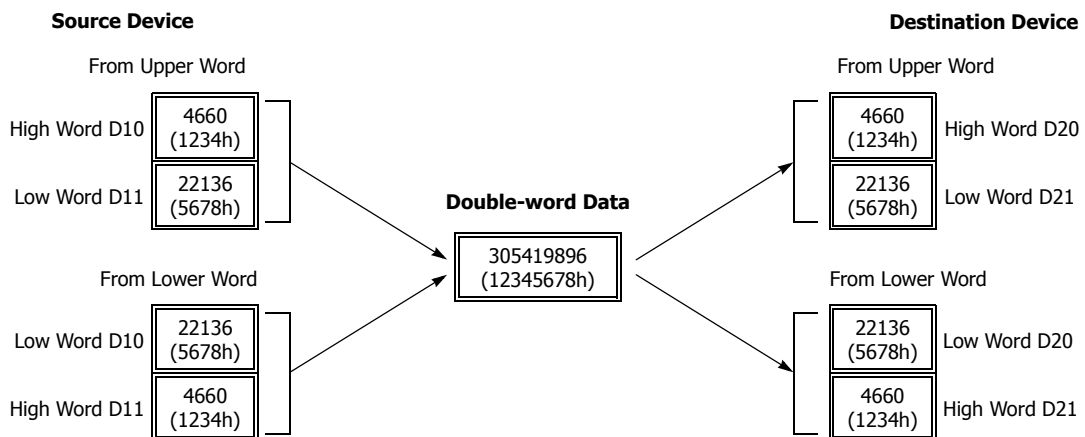

User Program Protection

You can enable protection for uploading and downloading the user program with WindLDR to help prevent the FC6A Series MICROSmart user program from being modified, erased, or stolen by a third party.

Protection can be individually configured for uploading and downloading the user program. There are three types of protection modes, which are detailed as follows:

Mode	Description
Unprotected	The user program is unprotected.
Password Protected	A password must be entered when downloading or uploading the user program. The password is six to eight single-width alphanumeric characters, and it must include a minimum of one number and one character. One password can be set for one user program. When applying password protection to both user program uploads and downloads, the same password is used.
Prohibited	The user program cannot be uploaded. Prohibited protection can only be configured for user program uploads. User program downloads cannot be prohibited.

For enhanced security, if the entered password does not match the user program password in the FC6A Series MICROSmart, the FC6A Series MICROSmart will not verify a new password for one second. Therefore, even if the correct password is entered within one second after a mismatch, that is a mismatch. If the password does not match, wait one second or longer and then enter the password again.

Note: When the user program is password protected, there are restrictions on uploading and downloading the user program using the SD memory card. For details, see "Download from SD Memory Card" on page 11-27.

Notes:

- Before proceeding with the following steps, make sure to note the protect code, which is needed to disable the user program protection. If the user program in the FC6A Series MICROSmart is write- or read/write-protected, the user program cannot be changed without the protect code.
- If the user program is read-protected without using a password, the read protection cannot be temporarily disabled using the password, thus the user program cannot be read out by any means. To disable the read protection, download another user program without user program protection.
- When the user program is protected, even if you enter the correct password and download the program, if protection is set for the downloaded user program, the protection will be once again enabled.
- If you do not download or upload the user program within 10 seconds of unlocking the protection, the protection will once again be enabled.

Programming WindLDR

1. From the WindLDR menu bar, select **Configuration > Program Protection**.

The **Function Area Settings** dialog box for Program Protection appears.

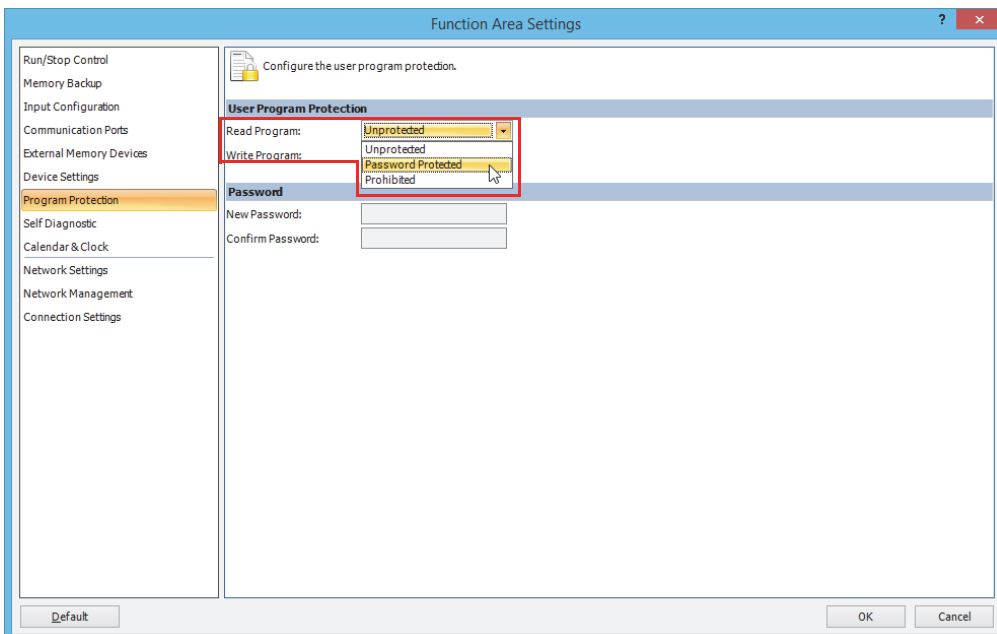

- Under **User Program Protection**, select required protect modes for **Read Program** and **Write Program** in the pull-down list.

Unprotected:	The user program in the FC6A Series MICROSmart can be read and written without a password.
Password Protected:	Prevents unauthorized copying or inadvertent replacement of the user program. This protection can be temporarily disabled using a predetermined password.
Prohibited:	Prevents copying of the user program completely. This option is available for read protection only and can not be temporarily disabled using a password.

- After selecting a required protect mode, enter a password of 6 through 8 ASCII characters from the key board in the **New Password** field, and enter the same password in the **Confirm Password** field.

- Click **OK** and download the user program to the FC6A Series MICROSmart after changing any of these settings.

Disabling Protection

When the user program is password-protected against read and/or write, the protection can be temporarily disabled using WindLDR.

If the user program is read-prohibited, the read protection cannot be disabled, thus the user program cannot be read by any means. To disable the read protection, download another user program without user program protection.

- From the WindLDR menu bar, select **Online > Download or Upload**.

When the user program in the FC6A Series MICROSmart is read and/or write protected, the Protect Error dialog box appears. When program verification or online edit is attempted, the Protect Error dialog box appears.

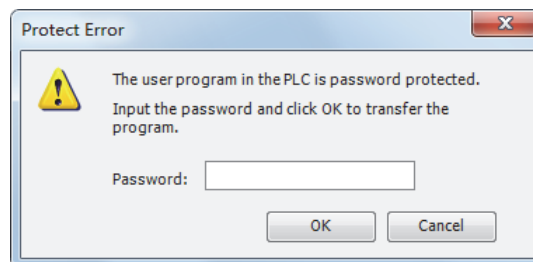

- Enter the password and click **OK**.

The user program protection is disabled only temporarily. When the FC6A Series MICROSmart is powered up again, the protection designated in the user program takes effect again.

To disable or change the protection permanently, change the protection settings and download the user program.

Watchdog Timer Setting

This section describes watchdog timer setting.

A watchdog error occurs when the processing time for one scan exceeds the allowed time while the user program is running.

If a watchdog error occurs, the system is reset with the purpose of returning the system to normal operation.

If the watchdog error occurs frequently, you can assume that there is a hardware problem and that the FC6A Series MICROSmart requires replacement.

Some of the reasons why a watchdog timer will occur are problems with the FC6A Series MICROSmart hardware and length of the processing time in the program. If the processing time for one scan of the ladder program exceeds the time configured for the watchdog timer on the ladder program, place an NOP (no operation) instruction in the ladder program. The watchdog timer is reset when the NOP instruction is executed.

Watchdog timer setting time

The watchdog timer setting time can be changed in the **Function Area Settings**. Decide on the watchdog timer setting time in either of the following two ways.

- **Decide by user system specification**

Determine the maximum on time (milliseconds) so the output signals do not stay on if the FC6A Series MICROSmart loses control and set that value as the watchdog timer setting time. However, if the ladder program processing time takes longer than the design specification, use an NOP (no operation) instruction in the ladder program. For example, when the watchdog timer is set to 100 ms and the maximum value for one scan is 120 ms on the ladder program, insert an NOP instruction in the ladder program to ensure that the error does not occur.

- **Match the program processing time**

Check the maximum value for one scan (D8024) and set the watchdog timer value as a value with a safety margin added to the maximum value.

Note: When changing the watchdog timer setting value, select an appropriate value that fully takes into consideration the safety of the system.

The maximum value of one scan while the FC6A Series MICROSmart is running can be checked with special data register D8024.

Programming WindLDR

1. Select **Configuration** from the WindLDR menu bar, and then click **Self Diagnostic**.
The **Function Area settings** dialog box appears.
2. Select the watchdog timer setting value.

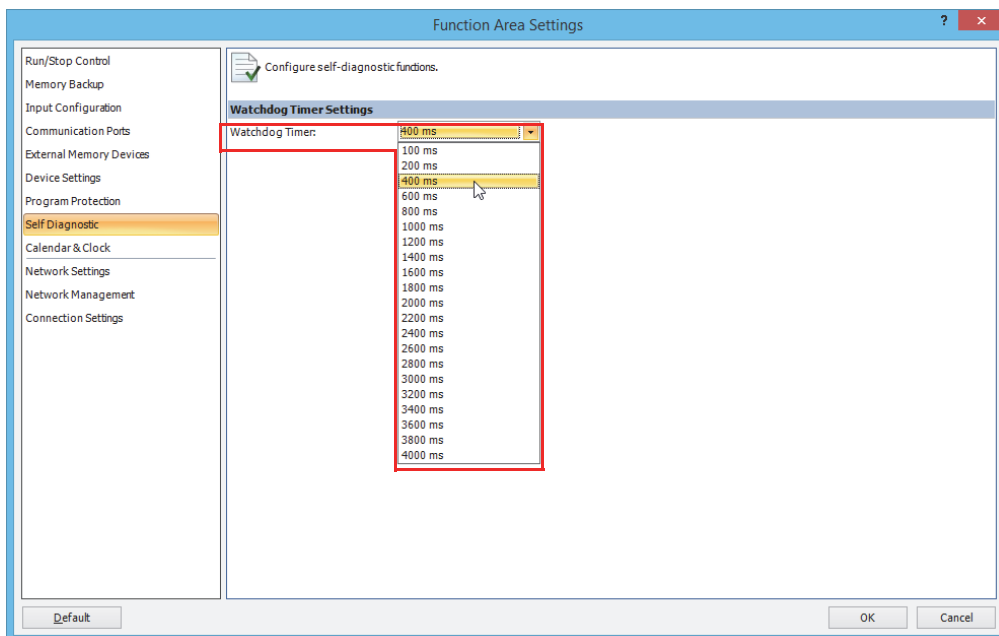

3. Click **OK**.

This concludes configuring the settings.

Watchdog Timer Settings

Select the watch dog timer setting between 100 ms and 4,000 ms. The default time is 400 ms.

Constant Scan Time

The scan time may vary whether basic and advanced instructions are executed or not depending on input conditions to these instructions. The scan time can be made constant by entering a required scan time preset value into special data register D8022 reserved for constant scan time. When performing accurate repetitive control, make the scan time constant using this function. The constant scan time preset value can be between 1 to 1,000 ms.

The scan time error is ±1 ms of the preset value normally. When the data link or other communication functions are used, the scan time error may be increased to several milliseconds.

When the actual scan time is longer than the scan time preset value, the scan time cannot be reduced to the constant value.

Special Data Registers for Scan Time

In addition to D8022, three more special data registers are reserved to indicate current, maximum, and minimum scan time values.

Note: R/W is the abbreviation for read/write. When R/W, it can be read and written. When R, it can only be read. When W, it can only be written.

D8022	Constant Scan Time Preset Value (1 to 1,000 ms)	R/W
D8023	Scan Time Current Value (ms)	R
D8024	Scan Time Maximum Value (ms)	
D8025	Scan Time Minimum Value (ms)	

Example: Constant Scan Time

This example sets the scan time to a constant value of 500 ms.

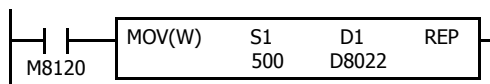

M8120 is the initialize pulse special internal relay.

When the FC6A Series MICROSmart starts operation, the MOV (move) instruction stores 500 to special data register D8022.

The scan time is set to a constant value of 500 ms.

Daylight Savings Time

This section describes the function that automatically adjusts the FC6A Series MICROSmart time according to daylight savings time settings.

For regions where the FC6A Series MICROSmart is used that implement daylight savings time, this function can automatically adjust the FC6A Series MICROSmart clock using the daylight savings time settings. When the time reaches the daylight savings start time, the clock is set an hour forward. When the time reaches the the daylight savings time end, the clock is set an hour back.

The FC6A Series MICROSmart adjusts the clock for daylight savings time on the start day and the end day. However, the clock is also adjusted for daylight savings time under the following conditions.

- When a user program was downloaded to the FC6A Series MICROSmart.
- When the FC6A Series MICROSmart power was turned on.

When the current time of the FC6A Series MICROSmart' internal clock is set using WindLDR or the operator interface, the time is not adjusted for daylight savings time, even if the time after it was set is within the daylight savings time period. Set the time to the time adjusted for daylight savings time. The set date and time becomes the date and time after being adjusted for daylight savings time.

Programming WindLDR

Configure daylight savings time on the FC6A Series MICROSmart.

1. From the WindLDR menu bar, select **Configuration > Calendar & Clock**. The **Function Area Settings** dialog box is displayed.
2. Select the **Enable Daylight Savings Time** check box.

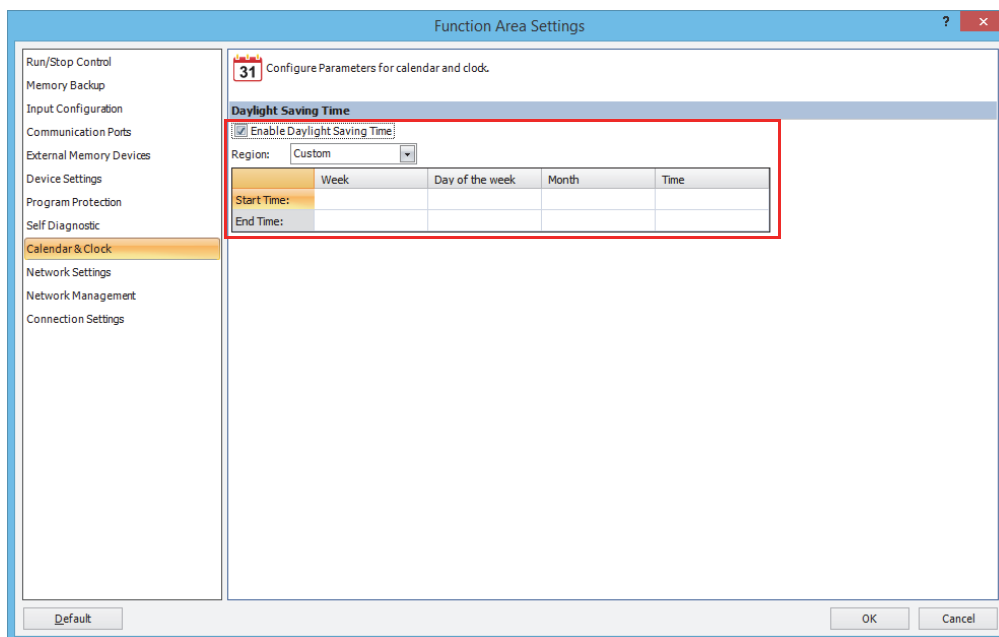

3. Configure the start time and the end time. Specify the region using the **Region** list box. If you select **Custom**, you are able to select any desired start time and end time.

Region	Start Time	End Time
Custom	User specified	User specified
USA or Canada	March, 2nd Sunday, 2:00 AM	November, 1st Sunday, 2:00 AM
Europe	March, last Sunday, 1:00 AM	October, last Sunday, 1:00 AM
Australia	October, 1st Sunday, 2:00 AM	April, 1st Sunday, 3:00 AM

4. Click **OK**.

This concludes configuring the settings.

Clock Function

This section describes the internal clock function on the FC6A Series MICROSmart.

This function enables you to control the time schedule for lighting or air conditioning equipment using the current time data stored in special data registers. The internal clock data is backed up by a backup battery. The current time is reset when the backup data is lost, so the current time will need to be set again.

Function	Description
Read clock	The current time (calendar, clock) is updated every 500 ms and automatically stored in the special data registers.
Set clock	Sets the current time (calendar, clock). Set the current time with WindLDR or a user program that uses the special data registers.
Adjust function	When clock data adjust flag M8021 is turned on from off, the seconds for the current time are rounded up or rounded down based on 30 seconds to correct the seconds data for the internal clock. If the current seconds are between 0 and 29 seconds, the seconds are set to 0 when M8021 is turned on from off. If the current seconds are between 30 and 59 seconds, the minutes are set to + 1 and the seconds are set to 0 when M8021 is turned on from off.
Calendar/clock error	M8013: This relay turns on if clock write processing or a clock adjust processing could not be executed normally. M8014: This relay turns on if an error occurs while calendar/clock data is read from the internal clock to the special data registers (D8008 to D8014).

Setting the Clock with WindLDR

Set the current time on the FC6A Series MICROSmart with WindLDR.

- From the WindLDR menu bar, select **Online > Monitor > Monitor**.
WindLDR enters monitor mode.
- Select **Online > PLC > Status**.
The PLC Status dialog box is displayed.
- Click **Change** for **Calendar**.
The Calendar Settings dialog box is displayed. The current time on the computer is displayed in the dialog box as the initial value. The settings can also be changed as necessary.

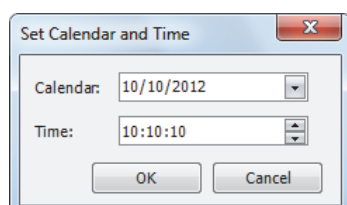

- Click **OK**.

The date and time configured in the dialog box is written to the FC6A Series MICROSmart.

Setting the Clock with a User Program

A user program can write the clock data from an operator interface without using WindLDR by using special data registers D8015 to D8021. Undefined values are stored in special data registers D8015 to D8021. Always store an appropriate value before turning on M8016, M8017, or M8020.

Calendar Data Write Flag (M8016)

After writing data to the write calendar special data registers (D8015 to D8018), turn M8016 off to on to set the internal clock with the data in D8015 to D8018 as the calendar data (year, month, day, day of the week). If the day of the week is wrong, the correct day of the week is automatically written according to the date.

Clock Data Write Flag (M8017)

After writing data to the write clock special data registers (D8019 to D8021), turn M8017 off to on to set the internal clock with the data in D8019 to D8021 as the clock data (hour, minute, second).

Calendar/Clock Data Write Flag (M8020)

After writing data to the write calendar/clock special data registers (D8015 to D8021), turn M8020 off to on to set the internal clock with the data in D8015 to D8021 as the calendar data (year, month, day, day of the week) and the clock data (hour, minute, second). If the day of the week is wrong, the correct day of the week is automatically written according to the date.

5: FUNCTIONS AND SETTINGS

Calendar and clock data storage locations

The calendar/clock data is stored in the following special data registers.

Special Data Register	Description	Range	Setting Timing
D8008	Calendar/Clock Current Data (Read only)	Year	0 to 99
D8009		Month	1 to 12
D8010		Day	1 to 31
D8011		Day of the week	0 to 6
D8012		Hour	0 to 23
D8013		Minute	0 to 59
D8014		Second	0 to 59
D8015	Calendar/Clock New Data (Write only)	Year	0 to 99
D8016		Month	1 to 12
D8017		Day	1 to 31
D8018		Day of the week	0 to 6
D8019		Hour	0 to 23
D8020		Minute	0 to 59
D8021		Second	0 to 59

*1 If the scan time is 500 ms or longer, D8008 to D8014 are updated with each scan.

For the day of the week data, the values below are stored in the special data registers.

Day of the week	Sunday	Monday	Tuesday	Wednesday	Thursday	Friday	Saturday
Value	0	1	2	3	4	5	6

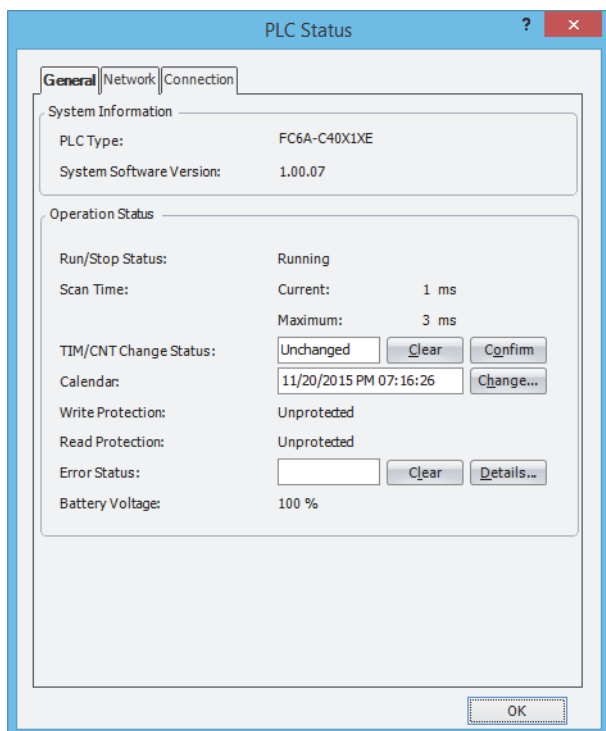

Example ladder program 1

This example sets the calendar and clock in a user program.

If you turn on M8020 with the new calendar/clock data set in the write-only data registers D8015 to D8021, the internal clock on the FC6A Series MICROSmart is updated with the current time (calendar, clock). In this example, the FC6A Series MICROSmart internal clock is set to 9:35:00 on Tuesday February 21, 2012.

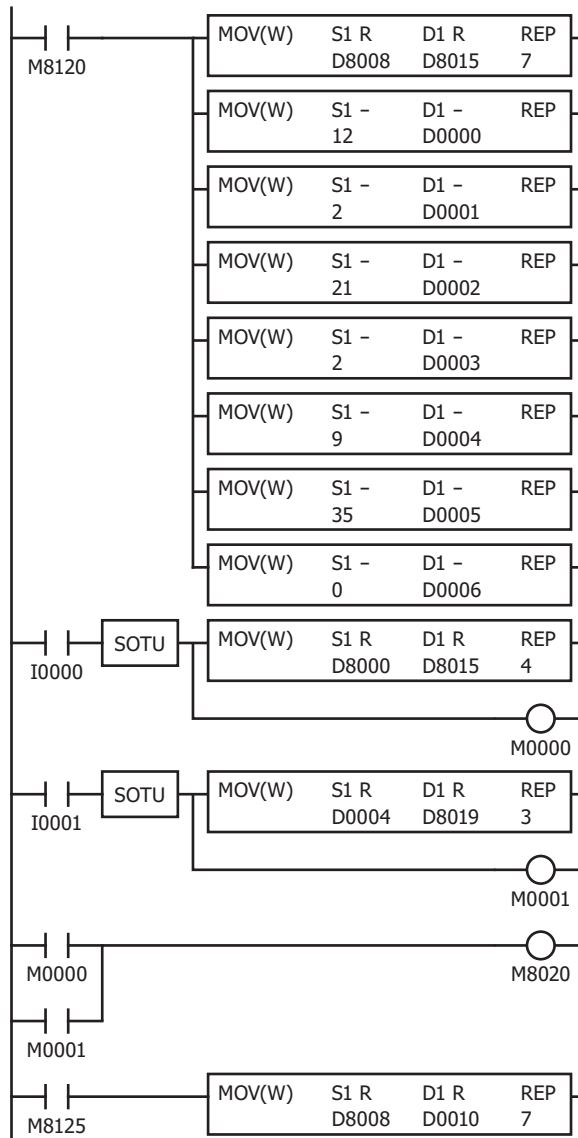

M8120 is the initial pulse that turns on for only one scan at the start of operation.

When the FC6A Series MICROSmart starts operating, the current calendar/clock data is stored in D8015 to D8021 and the new calendar/clock data is stored in D0 to D6 with the MOV (move) instruction.

When external input I0 turns on, the new calendar data is stored in special data registers D8015 to D8018.

Internal relay M0 turns on for one scan only.

When external input I1 turns on, the new clock data is stored in special data registers D8019 to D8021.

Internal relay M1 turns on for one scan only.

When external input M0 or M1 turns on, M8020 turns on and the calendar/clock data is written to the internal clock.
(M8020: Calendar/Clock Data Write Flag)

M8125 is a special internal relay that is always on during operation. While the FC6A Series MICROSmart is running, the current time (calendar, clock) is stored in D10 to D16 with the MOV instruction.

Example ladder program 2

When I1 turns off to on, the seconds on the internal clock are corrected to 0 seconds.

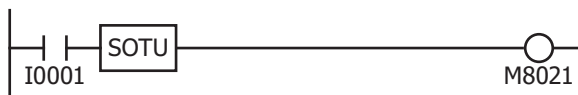

When input I1 turns on, clock data adjust flag M8021 turns on to correct the seconds on the internal clock.

Note: The internal clock backup time is guaranteed for one year. If the backup time is exceeded, the retained clock data is lost and the current time is initialized as 00:00:00 on January 1, 2000. For details on the battery, see "Battery Monitor" on page 5-66.

Battery Monitor

This section describes the battery monitor function that monitors the voltage of the FC6A Series MICROSmart backup battery.

Function Description

You can know when to change the backup battery before it dies by monitoring its voltage. The battery voltage in **mV** as measured after the FC6A Series MICROSmart power is turned on is stored in a special data register (D8056), and the battery level status is displayed on the battery status LED [BAT]. The battery voltage can also be measured at any time.

If the battery dies, device values are reset to their initial values when the power is turned off. Replace the backup battery before it dies.

Battery voltage (D8056)

Stores the measured battery voltage in **mV**. The range of the value is 0 to 3,000. If the value is greater than 3,000, this value is 3,000. The battery voltage fluctuates according to the usage environment.

When the power is turned on, this value is 65,535 until the initial battery voltage measurement has completed.

This value is 0 when there is a measurement error or when there is no battery.

Battery voltage measurement (M8074)

Shows the battery voltage measurement status.

0: Battery voltage measurement completed

1: Battery voltage being measured

The battery voltage can also be measured by writing 1. The measured value in **mV** is stored in D8056. The value is reset to 0 when the measurement has completed. The battery voltage is automatically measured once when the power is turned on and stored in D8056. For this reason, Battery Voltage Measurement Flag (M8074) does not normally need to be used.

 Caution	When Battery Voltage Measurement Flag (M8074) is used to measure the battery voltage, current will temporarily flow through the battery for A/D conversion processing inside the PLC. This consumes the battery, so minimize the use of Battery Voltage Measurement Flag (M8074). In particular, do not use Battery Voltage Measurement Flag (M8074) in ladder programs that perform constant measurements while running.
--	---

Battery level indicator

The status of the battery level is displayed on the battery status LED [BAT] according to the battery voltage value.

Replacing the battery on a regular schedule is recommended, regardless of whether the battery status LED is blinking or on. For details on the battery life, see "Backup Function" on page 2-17 and "Backup Function" on page 2-55.

Replace the battery immediately when the battery status LED is blinking (1-s cycle).

All-in-One CPU module Plus CPU module



Battery Status LED [BAT]	Condition	Battery Status	
Off	Battery voltage (D8056) > 2,300	Normal	Sufficient battery level.
Blinking (1 s cycle)	2,300 ≥ battery voltage (D8056) > 2,000	Warning	Low battery level. Replace the battery.
On	2,000 ≥ battery voltage (D8056)	Dead battery	The battery is almost dead. Or no battery.

 Caution	<ul style="list-style-type: none"> When the main power supply is off and the product is started with USB bus power, the monitoring of Battery Voltage (D8056) is performed in the same manner as in the above table. A general guide for the time it takes Battery Voltage (D8056) to decrease from 2300 to 2000 is approximately 10 days including the effect of the ambient environment (temperature and humidity) while unpowered and powered. Replace the battery immediately when the battery status LED is blinking (1-s cycle). The final voltage of the coin cell is 2000. If a battery that has reached its final voltage (battery status LED is on) is left in the product for a long period of time, the product may be damaged or malfunction.
--	---

General Errors Related to the Battery

When the power is turned on with a battery that is almost dead or without a battery, a keep data error and a clock error will occur.

Keep Data Error

When the power is turned off with a battery that is almost dead or without a battery, the data that is supposed to be backed up in RAM (keep data) cannot be backed up. A keep data error will occur and the keep data will be cleared in the following case:

- The status of keep data when the power supply was turned on has changed from when the power supply was previously turned off

Clock Error

When the power is turned off with a battery that is almost dead or without a battery, the clock data cannot be backed up. A clock error will occur and the clock data will be initialized in either of the following cases:

- Battery Voltage (D8056) measured when the power supply is turned ON is less than 2000*¹
- A keep data error occurs*²

*1 Applicable to the following versions. For versions before the following versions, the clock error will occur when Battery Voltage (D8056) is less than 2300.

All-in-One CPU module:	Version 2.10 and higher
CAN J1939 All-in-One CPU module:	Version 2.10 and higher
Plus CPU module:	Version 1.00 and higher

*2 Applicable to the following versions. For versions before the following versions, a clock error caused by a keep data error will not occur.

All-in-One CPU module:	Version 2.10 and higher
CAN J1939 All-in-One CPU module:	Version 2.10 and higher
Plus CPU module:	Version 1.50 and higher

USB Boot

This section describes USB boot startup that starts the FC6A Series MICROSmart using only USB bus power (5 V).

What USB boot can do

The function that starts the FC6A Series MICROSmart using only USB bus power (5 V) is called USB boot. USB boot enables the following.

- **Communicate with the FC6A Series MICROSmart using WindLDR and a USB connection to update the user program and system software**

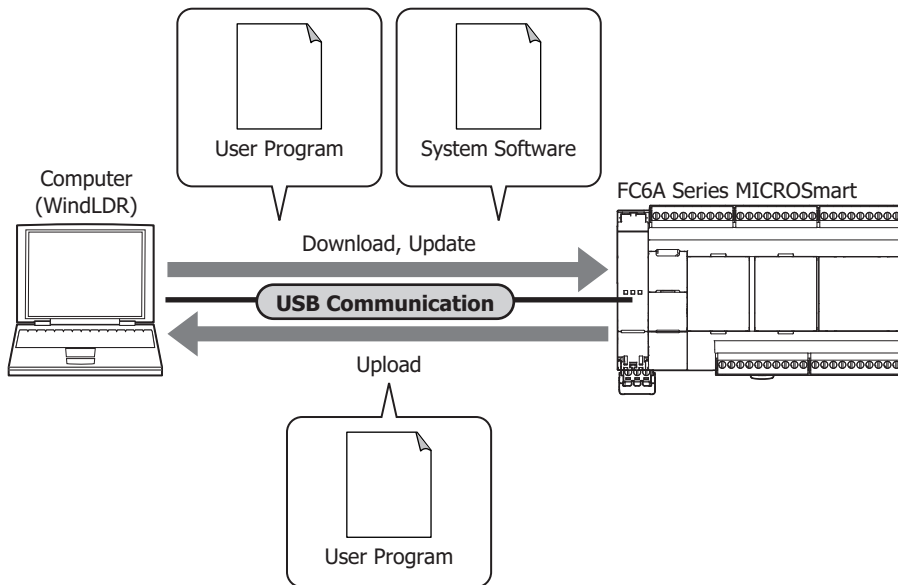

- **Overwrite the user program or system software on the FC6A Series MICROSmart with a user program and system software saved to an SD memory card**

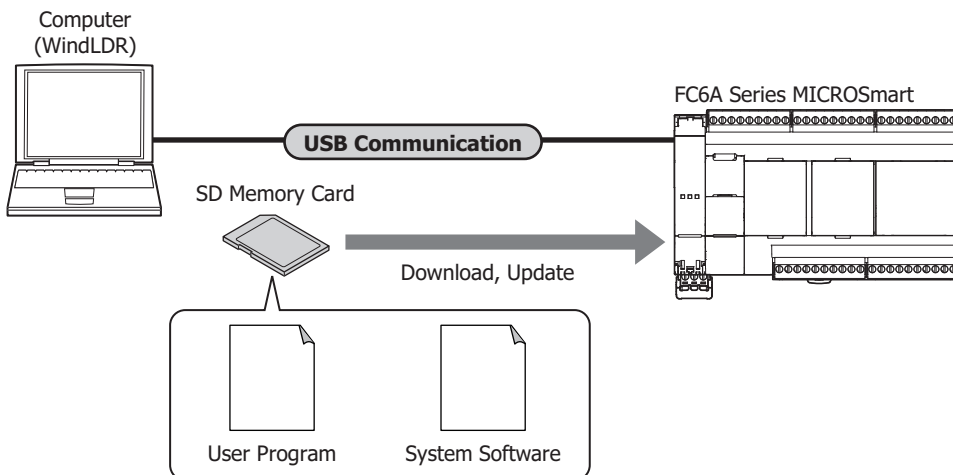

- **Read and write files on the SD memory card using WindLDR's Data File Manager**

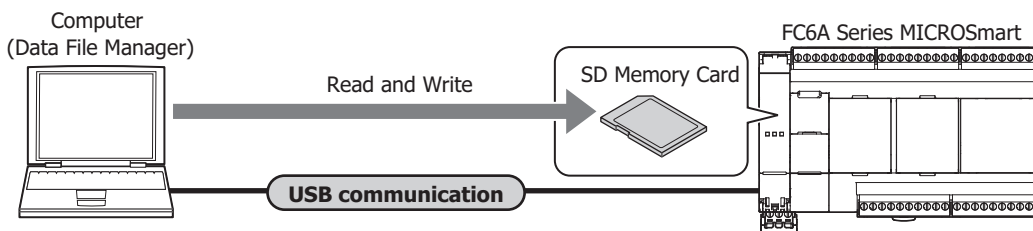

■ **Other operations**

- Set the time and calendar
- Change the content of keep devices (D, M, R, C)
- Update data by recipe

Starting and stopping USB boot

Starting USB boot

1. Connect a USB cable to the USB port of a computer.
2. When the FC6A Series MICROSmart's power is not supplied, plug the USB cable (5 V) into the USB port of the FC6A Series MICROSmart.

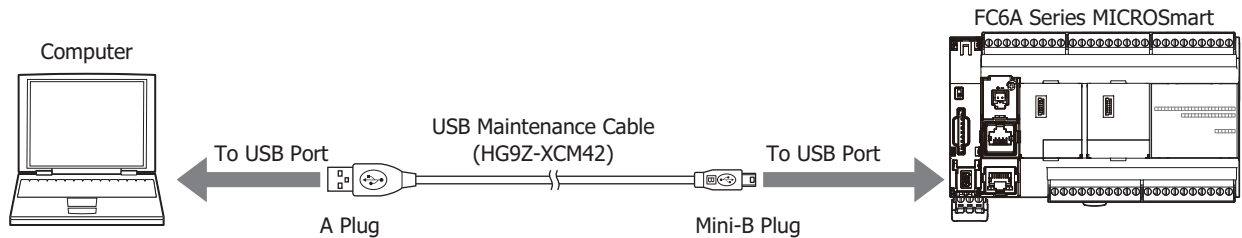

When the FC6A Series MICROSmart is started by the USB bus, the power indicator LED [PWR] is off and the operation indicator LED [RUN] is blinking.

All-in-One CPU module Plus CPU module

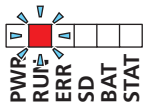

The operation indicator LED [RUN] blinks at an interval of 100 ms.

Note: The FC6A Series MICROSmart operating status can be checked with the PLC Status dialog box. During USB boot, **USB boot** is displayed for **Run/Stop Status**.

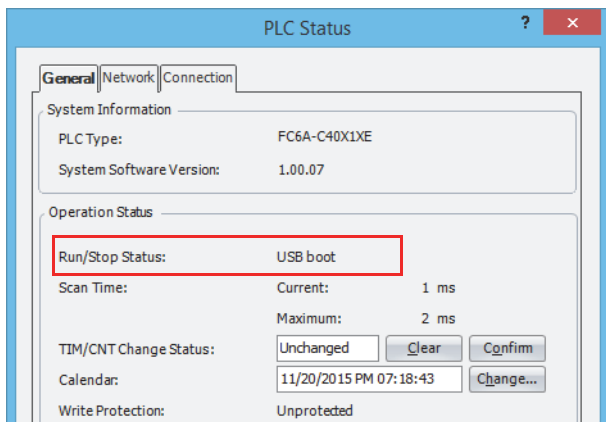

Stopping USB boot

USB boot can be stopped by unplugging the USB cable from the FC6A Series MICROSmart. USB boot also stops when power (24V DC, 12V DC, 100-240V AC) is supplied during USB boot, and operation switches to that power (24V DC, 12V DC, 100-240V AC).

Restrictions

During USB boot, peripheral functions other than the USB port and SD memory card do not operate.

User Program Capacity

This section describes the function to select the user program capacity on the FC6A Series MICROSmart.

Function Description

If the default FC6A Series MICROSmart user program capacity is insufficient, you can secure a larger user program capacity. However, Online Edit can no longer be used.

CPU Module Type	User Program Capacity	
	Default Capacity	When Securing a Larger User Program Capacity
All-in-One CPU Module	72,000 bytes (9,000 steps)	384,000 bytes (48,000 steps)
CAN J1939 All-in-One CPU Module		640,000 bytes (80,000 steps)
Plus CPU Module	800,000 bytes (100,000 steps)	

Programming WindLDR

You can set the user program capacity of the All-in-One CPU module and CAN J1939 All-in-One CPU module.

The Plus CPU module is fixed to 800,000 bytes.

1. On the **Configuration** tab, in the **Function Area Settings** group, click **Device Settings**.
The **Function Area Settings** dialog box is displayed.
2. For **Program Capacity Selection**, select 72,000 bytes, 384,000 bytes (All-in-One CPU module), or 640,000 bytes (CAN J1939 All-in-One CPU module).

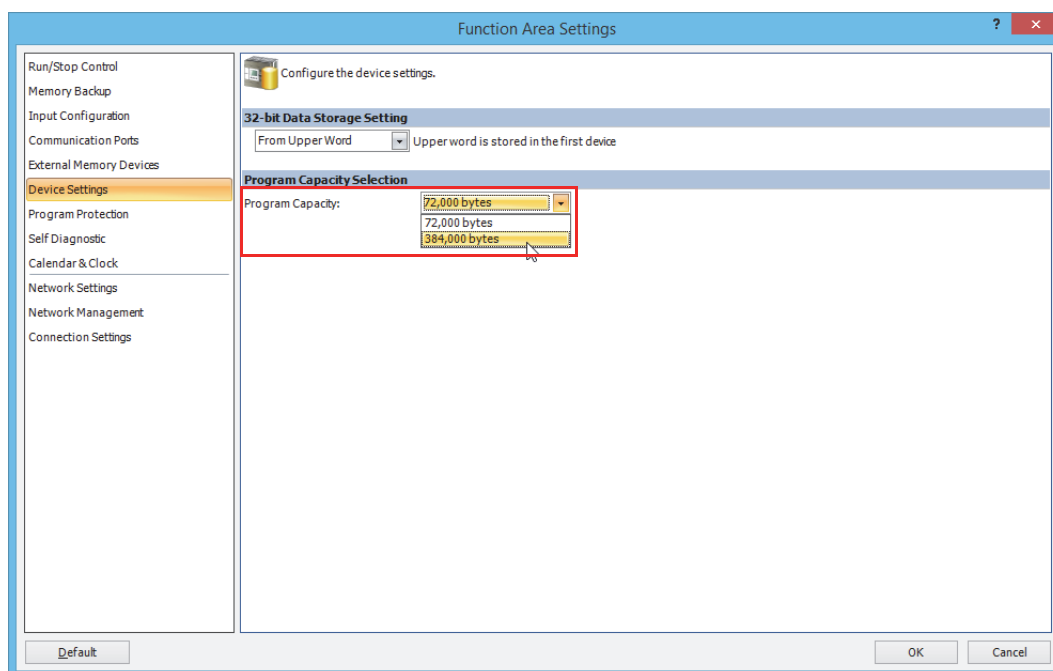

3. Click **OK**.

This concludes configuring the settings.

Online Edit

This section describes the Online Edit function that allows rewriting user programs and checking operation after rewriting without stopping FC6A Series MICROSmart operation.

Run-time download function

This section describes the run-time download function that rewrites the user program without stopping FC6A Series MICROSmart operation.



Warning

- Rewriting the program during operation is extremely dangerous. Carefully read and understand the function description and precautions before using the function.
- If a user program syntax error or a user program download error occurs, the FC6A Series MICROSmart will stop operation (STOP) and all outputs will be cleared. Depending on the subject being controlled, this may be extremely dangerous.
- When run-time download is executed, the MICROSmart immediately switches to the new program when the program has finished being transferred, but it may take a maximum of 30 seconds to save the program to ROM. During this period, the scan time for each scan increases in length about 10 to 400 ms.
- When using Online Edit, under no circumstances should you turn off the FC6A Series MICROSmart power or unplug the communication cable. The result may be a serious error such as a user program download error, and depending on the subject being controlled, this may be extremely dangerous.
- Device Q values are kept before and after run-time download. Therefore, when OUT/OUTN instructions are deleted or device numbers are changed, device Q before the change keep their status before run-time download. Depending on the subject being controlled, this may be extremely dangerous.

Function Description

A program can be downloaded and changed at the next ladder scan during MICROSmart operation.

During run-time download, devices Q, M, R, T (current value), C (current value), and D keep their status before run-time download. TP (preset value) and CP (preset value) are overwritten with the preset values of the newly written user program.

Notes:

- Before executing run-time download, always check the changed content and the program operation after it is written. There are no restrictions on the scope of editing with run-time download, but if many changes are made at one time, the possibility of triggering unexpected actions will increase. Keep program changes with run-time download to a minimum.
- If PID, PIDA, AVRG, DGRD, DISP, PULS, PWM, RAMP, ARAMP, JOG, or ZRN instructions are created or edited, the instructions are not initialized unless the input to the instruction is turned off for one or more scans. When copied instructions are pasted in the program, and when instructions that have been commented out are enabled, these are regarded as new instructions.
- SOTU/SOTD instructions are initialized at the first scan after the run-time download has completed.
- For user communication instructions (TXD, RXD, ETXD, ERXD), if instruction information remains in the instruction setup area, communication is performed according to the information before run-time download until all of the instructions in the setup area have sent or received their data, even when the instruction information is overwritten by run-time download. All RXD instructions in the setup area can be deleted by turning on the receive cancel flag assigned to each communication port.
- Run-time download can only be executed when the FC6A Series MICROSmart is operating (RUN).

Run-time download can only be executed when WindLDR is in Online Edit mode. To start Online Edit mode, the user program opened in WindLDR and the user program running on the FC6A Series MICROSmart must be the same.

During Online Edit, **Function Area Settings** and expansion data register settings cannot be changed. Only the ladder program can be edited.

Notes:

- If run-time download is performed when FC6A Series MICROSmart timer and counter preset values have been changed by the online monitor or HMI module, the changed values are overwritten by the values of the program that is newly written. To keep the FC6A Series MICROSmart timer preset values and counter preset values before and after run-time download, confirm the timer and counter preset value changes, upload the program, and then start Online Edit. To confirm timer and counter preset value changes, on the **Online** tab, in the **PLC** group, click **Status**, and then click **Confirm** under **TIM/CNT preset value**.
- During Online Edit, function area settings and expansion data register settings cannot be changed. To change these, download the entire user program with a normal download.
- If communication was lost during run-time download, the program being executed in RAM and the program saved to ROM may not be the same. In this situation, exit Online Edit and download the program.
- After downloading or uploading the user program, start Online Edit when the WindLDR user program and the program running on the FC6A Series MICROSmart are the same. Online Edit cannot start if the programs are different.

5: FUNCTIONS AND SETTINGS

Initialize pulse after run-time download (M8126)

M8126 is a special internal relay that turns on for only one scan after run-time download has completed. This is effective when you want to reliably initialize instructions after run-time download.

Example: A user program that initializes the AVRG instruction during run-time download

Even if the status of M0 is on during run-time download, the input to the AVRG instruction turns off for only one scan time by normally-closed M8126, and the instruction is initialized.

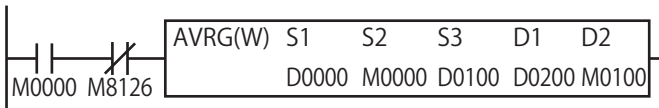

Example: A user program that cancels RXD instructions in standby during run-time download

The user communication receive instruction cancel flag (port 1) turns on for only one scan during run-time download and all RXD instructions in standby are canceled.

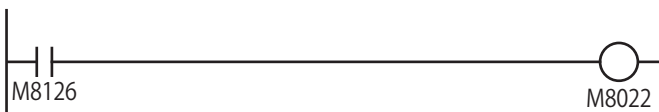

WindLDR Online Edit and run-time download operations

Program to create

Add rung 4 with the following specification to the program created in Chapter 4. When input I0 and input I1 are both off, output Q3 turns on.

Rung Number	I0	I1	Operation
4	OFF	OFF	Output Q3 is ON

• Operation procedure

1. Start Online Edit.

After downloading or uploading the user program, when the FC6A Series MICROSmart and WindLDR programs are the same, on the **Online** tab, in the **Monitor** group, click **Online Edit** under **Monitor**.

Online Edit mode starts and a program can be edited with FC6A Series MICROSmart's operation being monitored.

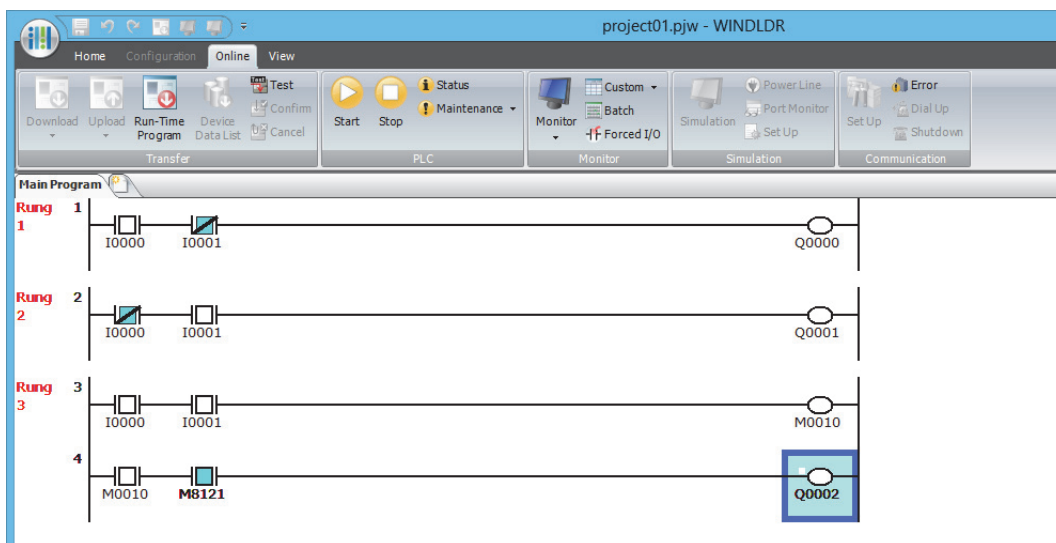

2. Create a program.

Add rung 4 and insert the instructions according to the specification.

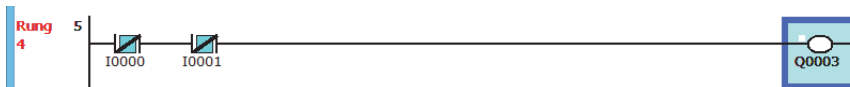

3. Execute run-time download.

On the **Online** tab, in the **Transfer** group, click **Run-Time Program Download**.

The Download dialog box is displayed.

The user program is written to the FC6A Series MICROSmart when you click OK.

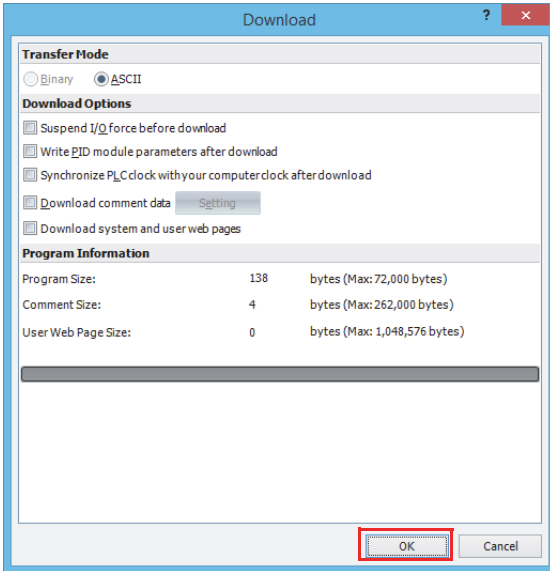

4. Check the operation of the program.

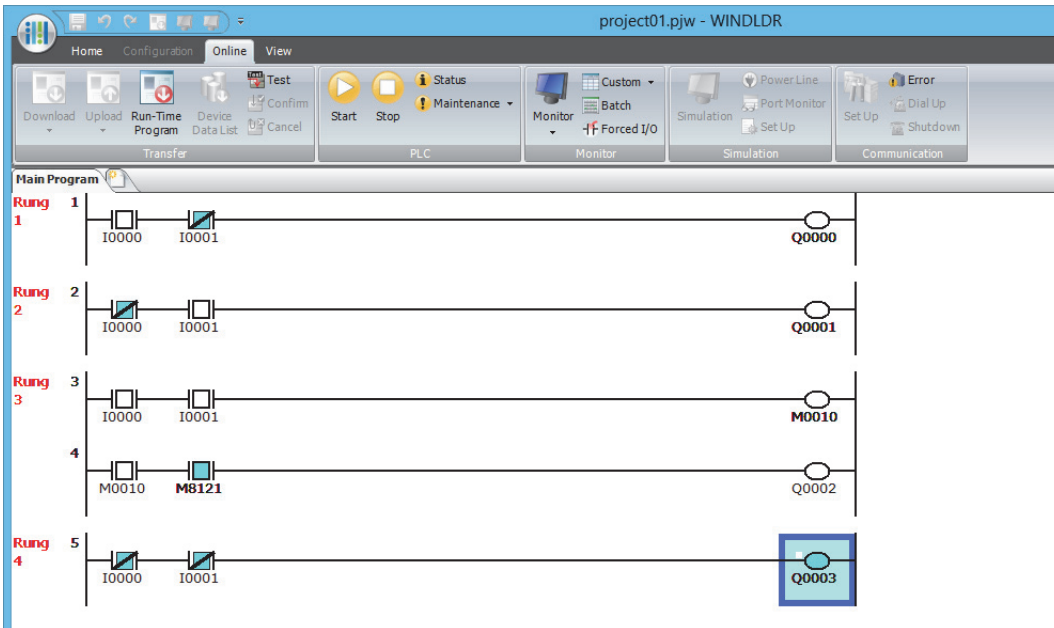

Rung 4: When both input I0 and I1 are off, output Q3 turns on.

5. Exit Online Edit.

On the **Online** tab, in the **Monitor** group, click **Online Edit** under **Monitor**.

This exits Online Edit.

Test Programming Function

This section describes the test programming function that rewrites the user program without stopping FC6A Series MICROSmart operation and allows you confirm or cancel those changes after checking the operation of the program.

Warning

- Rewriting the program during operation is extremely dangerous. Carefully read and understand the function description and precautions before using the function.
- Before executing test programming, confirming test programming, or canceling test programming, always check and double check the changed content and the operation of the program. There are no restrictions on the scope of editing with test programming, but if many changes are made at one time, the possibility of triggering unexpected actions will increase. Keep program changes with test programming to a minimum.
- If a user program syntax error or a user program download error occurs, the FC6A Series MICROSmart will stop operation (STOP) and all outputs will be cleared. Depending on the subject being controlled, this may be extremely dangerous.
- Test programming can be repeatedly executed, but when the test programming is canceled, all test programming is canceled at once, and the MICROSmart is restored to the program before test programming. When the test programming is canceled after repeated test programming, the changed content will be difficult to understand when the MICROSmart is restored to the original program and the possibility of trigger unexpected actions will increase. Keep the number of times test programming is performed to a minimum.
- When exiting Online Edit after test programming, always confirm or cancel the test programming, or perform run-time download. When the test programming is not confirmed or canceled and run-time download is not performed after test programming, the program stored in ROM and the program being executed in RAM will not be the same. The program in RAM will be cleared when the CPU module power is turned off, and then it will be overwritten by the program saved in ROM when the power is turned on. Unexpected actions may be triggered in this situation, and depending on the subject being controlled, this may be extremely dangerous.
- When using Online Edit, under no circumstances should you turn off the FC6A Series MICROSmart power or unplug the communication cable. The result may be a serious error such as a user program download error, and depending on the subject being controlled, this may be extremely dangerous.
- Device Q values are kept before and after test programming and cancel test programming. Therefore, when OUT/OUTN instructions are deleted or device numbers are changed, device Q before the change keeps the status. Depending on the subject being controlled, this may be extremely dangerous.

Function Description

With test programming, a program can be downloaded and changed at the next ladder scan during MICROSmart operation. Next, after checking the operation of the changed program, you can select to confirm or cancel the test programming. If the test programming is confirmed, the program that was overwritten by the test programming is written to ROM and it becomes permanent. If the test programming is canceled, the program that was overwritten by the test programming is restored to the program saved in ROM.

During test programming and cancel test programming, devices Q, M, R, T (current value), C (current value), and D keep their previous status. TP (preset value) and CP (preset value) are overwritten with the preset values of the user program after it is changed.

Notes:

- When the test programming is canceled, only the user program is restored. The contents of the devices are not restored.
- When test programming is executed, the MICROSmart immediately switches to the new program when the program has finished being transferred.
- It takes a maximum of 30 seconds to save the program being executed in RAM to ROM by confirming the test programming. During this period, the scan time for each scan increases in length about 10 to 130 ms.
- When the test programming is canceled, the program is restored to the program before test programming, but the device values are kept and not restored.
- After test programming and cancel test programming are completed, M8126 turns on for only one scan.
- If test programming is performed and the test programming is confirmed when FC6A Series MICROSmart timer or counter preset values have been changed by communication or advanced instructions, the preset values of the program being executed in RAM are overwritten. When test programming is canceled, the preset values are restored to the values before test programming.
- If PID, PIDA, PIDD, AVRG, DGRD, DISP, PULS, PWM, RAMP, RAMPL, ARAMP, JOG, or ZRN instructions are created or edited, the instructions are not initialized unless the input to the instruction is turned off for one or more scans. When instructions are pasted in the program, and when instructions that have been commented out are enabled, these are regarded as new instructions.
- SOTU/SOTD instructions are initialized at the first scan after test programming and cancel test programming have completed.
- For user communication instructions (TXD, RXD, ETXD, ERXD), if instruction information remains in the instruction setup area, communication is performed according to the information before the program was overwritten until all of the instructions in the setup area have sent or received their data, even when the instruction information is overwritten by test programming and cancel test programming. All RXD instructions in the setup area can be deleted by turning on the receive cancel flag assigned to each communication port.
- Test programming, test programming confirmation, and test programming cancellation can only be executed when the FC6A is operating (RUN).

Test programming, test programming confirmation, and test programming cancellation can only be executed during Online Edit mode. These are all executed during FC6A Series MICROSmart operation (RUN).

Notes:

- During Online Edit, function area settings and expansion data register settings cannot be changed. To change these, download the entire user program with a normal download.
- If communication was lost during test programming, test programming confirmation, or test programming cancellation, the program being executed in RAM and the program saved to ROM may not be the same. In this situation, exit Online Edit and download the program.
- After downloading or uploading the user program, start Online Edit when the WindLDR user program and the program running on the FC6A Series MICROSmart are the same. Online Edit cannot start if the programs are different.

WindLDR Online Edit and test programming operations

Program to create

Add rung 4 with the following specification to the program created in Chapter 4, and after testing operation with the test program, confirm or cancel the test programming.

When input I0 and input I1 are both off, output Q3 turns on.

Rung Number	I0	I1	Operation
4	OFF	OFF	Output Q3 is ON

• Operation procedure

1. Start Online Edit.

After downloading or uploading the user program, when the FC6A Series MICROSmart and WindLDR programs are the same, on the **Online** tab, in the **Monitor** group, click **Online Edit** under **Monitor**.

Online Edit mode starts and the operation of the FC6A Series MICROSmart is monitored and the program can be edited.

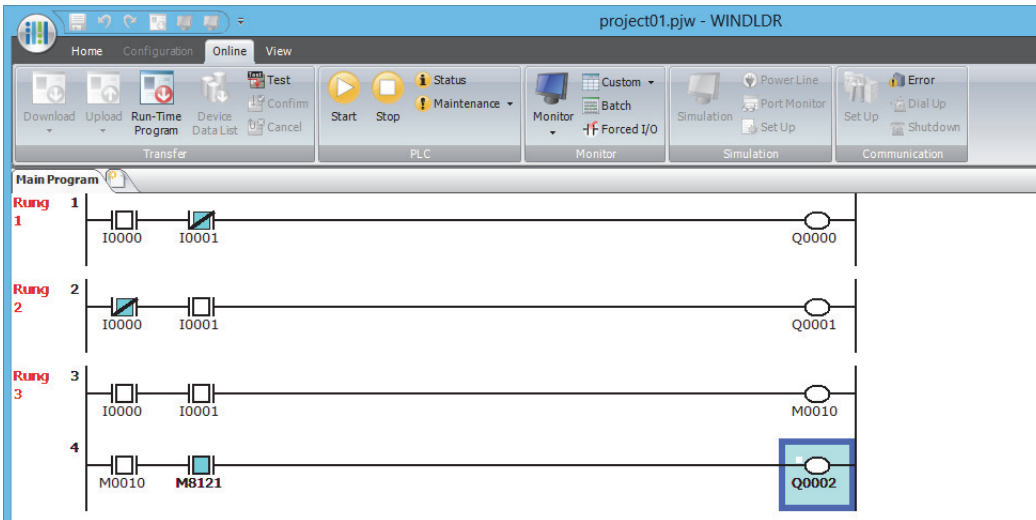

2. Create a program.

Add rung 4 and insert the instructions according to the specification.

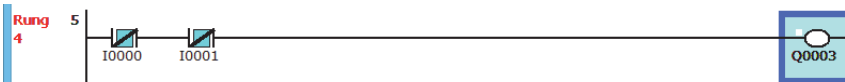

3. Execute the test programming.

On the **Online** tab, in the **Transfer** group, click **Test**.

The **Download** dialog box is displayed.

The user program is written to the FC6A Series MICROSmart when you click **OK**.

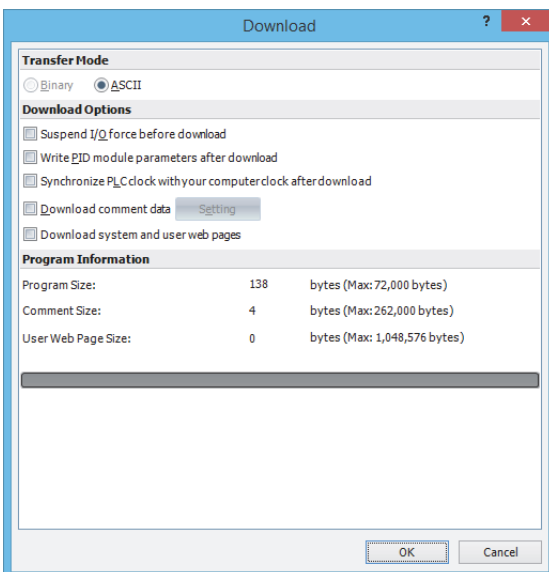

4. Check the operation of the program.

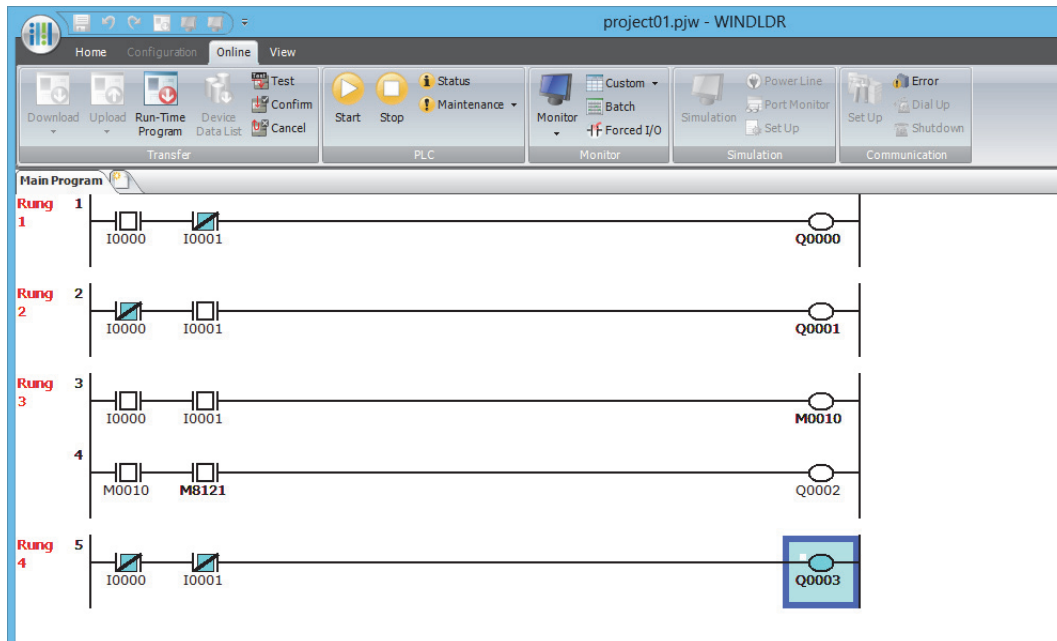

Rung 4: When both input I0 and I1 are off, output Q3 turns on.

5. To confirm the test programming, on the **Online** tab, in the **Transfer** group, click **Confirm**.
A confirmation message is displayed. Click **Yes** to save the program overwritten by the test programming to ROM and to make it permanent.
 6. To cancel the test programming, on the **Online** tab, in the **Transfer** group, click **Cancel**.
A confirmation message is displayed. Click **Yes** to restore the program that was overwritten by the test programming to the program saved in ROM.
- Note:** Devices overwritten by checking operation after test programming are also kept after test programming is canceled. For the above example, if the test programming is canceled when Q3 is on, it keeps the on status. Depending on the subject being controlled, this may be extremely dangerous.
7. Exit Online Edit.
On the **Online** tab, in the **Monitor** group, click **Online Edit** under **Monitor**.
This exits Online Edit.

Note: You cannot exit Online Edit if the test programming has not been confirmed or canceled after test programming, or if run-time download has not been executed.

6: DEVICES

This chapter provides detailed descriptions of the allocations of devices such as inputs, outputs, internal relays, registers, timers, and counters that are used in the basic and advanced instructions, as well as details about the allocations of special internal relays and special data registers.

Please use this chapter as a reference for the devices.

Note: The programming and operation of FC6A Series MICROSmart user programs requires specialist knowledge.

Take the time to develop a thorough understanding of the contents and programs in this manual before using the FC6A Series MICROSmart.

Device Addresses

All-in-One CPU Module/J1939 All-in-One CPU Module

Device	Symbol	Unit	Range (Points)		
			16-I/O Type	24-I/O Type	40-I/O Type
Inputs*1	I	Bit	I0 - I10 (9 points)	I0 - I15 (14 points)	I0 - I27 (24 points)
Expansion Inputs*1	I	Bit	I30 - I187 (128 points) I190 - I507*2 (256 points) I630 - I633*4 (4 points)	I30 - I307 (224 points) I310 - I627*3 (256 points) I630 - I633*4 (4 points)	I30 - I307 (224 points) I310 - I627*3 (256 points) I630 - I637*4 (8 points)
Output*1	Q	Bit	Q0 - Q6 (7 points)	Q0 - Q11 (10 points)	Q0 - Q17 (16 points)
Expansion Outputs*1	Q	Bit	Q30 - Q187 (128 points) Q190 - Q507*2 (256 points) Q630 - Q633*4 (4 points)	Q30 - Q307 (224 points) Q310 - Q627*3 (256 points) Q630 - Q633*4 (4 points)	Q30 - Q307 (224 points) Q310 - Q627*3 (256 points) Q630 - Q637*4 (8 points)
Internal Relay*1	M	Bit		M0 - M7997 (6,400 points) M10000 - M17497 (6,000 points)	
Special Internal Relay*1	M	Bit		M8000 - M8317 (256 points)	
Shift Register	R	Bit		R0 - R255 (256 points)	
Timer	T	Bit/Word		T0 - T1023 (1,024 points)	
Counter	C	Bit/Word		C0 - C511 (512 points)	
Data Register	D	Bit/Word		D0000 - D7999 (8,000 points) D10000 to D55999 (46,000 points)	
Special Data Register	D	Bit/Word		D8000 - D8499 (500 points)	
Index Register*5	P	2 words		P0 - P15 (16 points)	

*1 The least significant digit of the device address is an octal number (0 to 7).

*2 I190 to I507 and Q190 to Q507 are devices that can only be used when expansion modules are connected at the expansion interface side using the expansion interface module (expander).

*3 I310 to I627 and Q310 to Q627 are devices that can only be used when expansion modules are connected at the expansion interface side using the expansion interface module (expander).

*4 I630 to I637 and Q630 to Q637 are devices that can be used only when I/O cartridges are connected.

*5 The data type that can be used is L (Long) only.

6: DEVICES

Plus CPU module

Device	Symbol	Unit	Range (Points)	
			Plus 16-I/O Type	Plus 32-I/O Type
Inputs* ¹	I	Bit	I0 - I7 (8 points)	I0 - I17 (16 points)
Expansion Inputs* ¹	I	Bit	I30 - I307 (224 points) I310 - I627* ² (256 points) I630 - I643* ³ (12 points) I1000 - I10597* ⁴ (2,016 points)	
Output* ¹	Q	Bit	Q0 - Q7 (8 points)	Q0 - Q17 (16 points)
Expansion Outputs* ¹	Q	Bit	Q30 - Q307 (224 points) Q310 - Q627* ² (256 points) Q630 - Q643* ³ (12 points) Q1000 - Q10597* ⁴ (2,016 points)	
Internal Relay* ¹	M	Bit	M0 - M7997 (6,400 points) M10000 - M21247 (9,000 points)	
Special Internal Relay* ¹	M	Bit	M8000 - M9997 (1,600 points)	
Shift Register	R	Bit	R0 - R255 (256 points)	
Timer	T	Bit/Word	T0 - T1999 (2,000 points)	
Counter	C	Bit/Word	C0 - C511 (512 points)	
Data Register	D	Bit/Word	D0000 - D7999 (8,000 points) D10000 - D61999 (52,000 points)	
Non-retentive Data Register	D	Bit* ⁷ /Word	D70000 - D269999* ⁵ (200,000 points)	
Special Data Register	D	Bit/Word	D8000 - D8899 (900 points)	
Index Register* ⁶	P	2 words	P0 - P15 (16 points)	

*1 The least significant digit of the device address is an octal number (0 to 7).

*2 I1310 to I627 and Q310 to Q627 are devices that can only be used when expansion modules are connected at the expansion interface side using the expansion interface module (expander). (Node 0)

*3 I630 to I643 and Q630 to Q643 are devices that can be used only when I/O cartridges are connected.

*4 I1000 to I10597 and Q1000 to Q10597 are devices that can be used only when expansion modules are connected using the expansion interface modules (remote master and slaves) and the expansion interface modules (expander). (Node 1 to 10)

*5 D70000 to D269999 cannot be designated as "Keep." Data register values are kept when you switch the PLC from Stop to Run, but those values are cleared at power up.

*6 The data type that can be used is L (Long) only.

*7 Usable only in scripts executed by the SCRPT instruction and as argument devices used in UMACRO instructions.

■ Inputs (I), Expansion Inputs (I)

Devices that input on/off information from external devices to the FC6A Series MICROSmart.

■ Outputs (Q), Expansion Outputs (Q)

Devices that output on/off information from the FC6A Series MICROSmart to external devices.

■ Internal Relays (M)

Bit devices used internally on the FC6A Series MICROSmart.

■ Special Internal Relays (M)

Bit devices used internally on the FC6A Series MICROSmart. Special functions are assigned to each bit.

■ Shift Registers (R)

Bit devices that are used with the SFR instruction and the SFRN instruction. The bit sequence of the data is shifted according to pulse input.

■ Timer (T)

Timers used internally in the FC6A Series MICROSmart. There are three devices: Timer bits (symbol: T, unit: bit), timer preset values (symbol: TP, unit: word), and timer current values (symbol: TC, unit: word).

These can be used as an on-delay timer or an off-delay timer. For details on timers (T), see "Using Timer or Counter as Source Device" on page 8-6.

■ Counters (C)

Counters used internally in the FC6A Series MICROSmart. There are three devices: Counter bits (symbol: C, unit: bit), counter preset values (symbol: CP, unit: word), and counter current values (symbol: CC, unit: word). These can be used as an adding counter or a reversible counter. For details on counters (C), see "Using Timer or Counter as Source Device" on page 8-6.

■ Data Registers (D)

Word devices that are used for writing numerical data internally in the FC6A Series MICROSmart. These can also be used as bit devices.

■ Special Data Registers (D)

Word devices that are used for writing numerical data internally in the FC6A Series MICROSmart. Special functions are assigned to each data register. These can also be used as bit devices.

Notes:

- Although the device symbol for internal relays (M0000 to M7997, M10000 to M21247) and special internal relays (M8000 to M9997) is the same ("M"), the device characteristics are different. Special functions are assigned to each bit of the special internal relays.
- Although the device symbol for the data registers (D0000 to D7999, D10000 to D61999, D70000 to D269999) and special data registers (D8000 to D8899) is the same ("D"), the device characteristics are different. Special functions are assigned to each special data register.

Special Internal Relay

Special Internal Relay Device Addresses

**Warning**

Do not write to data in the area marked as reserved in the special internal relays list. Otherwise the system may not operate correctly.

Note: R/W is an abbreviation for read/write.

The notation for the R/W field is as follows.

R/W: The device can be both read from and written to

R: Read-only

W: Write-only

Device Address	Description	When Stopped	Power OFF	R/W	
M8000	Start Control	Maintained	Maintained	R/W	
M8001	1-s Clock Reset	Cleared	Cleared	R/W	
M8002	All Outputs OFF	Cleared	Cleared	R/W	
M8003	Carry (Cy) or Borrow (Bw)	Cleared	Cleared	R/W	
M8004	User Program Execution Error	Cleared	Cleared	R/W	
M8005	Communication Error	Maintained	Cleared	R/W	
M8006	Communication Prohibited Flag (When Data Link Master)	Maintained	Maintained	R/W	
M8007	Initialization Flag (When Data Link Master)/Stop Communication Flag (When Data Link Slave)	Cleared	Cleared	R/W	
M8010	Status LED Operation	Operating	Cleared	R/W	
M8011 M8012	— Reserved —	—	—	—	
M8013	Calendar/Clock Data Write/Adjust Error Flag	Operating	Cleared	R/W	
M8014	Calendar/Clock Data Read Error Flag	Operating	Cleared	R/W	
M8015	— Reserved —	—	—	—	
M8016	Calendar Data Write Flag	Operating	Cleared	R/W	
M8017	Clock Data Write Flag	Operating	Cleared	R/W	
M8020	Calendar/Clock Data Write Flag	Operating	Cleared	R/W	
M8021	Clock Data Adjust Flag	Operating	Cleared	R/W	
M8022	User Communication Receive Instruction Cancel Flag (Port 1)	Cleared	Cleared	R/W	
M8023	User Communication Receive Instruction Cancel Flag (Port 2)	Cleared	Cleared	R/W	
M8024	BMOV/WSFT Executing Flag	Maintained	Maintained	R/W	
M8025	Maintain Outputs While Stopped	Maintained	Cleared	R/W	
M8026	User Communication Receive Instruction Cancel Flag (Port 3)	Cleared	Cleared	R/W	
M8027	High-speed Counter (Group 1/I0)	Count Direction Flag	Maintained	Cleared	R/W
M8030		Comparison Output Reset	Cleared	Cleared	R/W
M8031		Gate Input	Maintained	Cleared	R/W
M8032		Reset Input	Maintained	Cleared	R/W
M8033	User Communication Receive Instruction Cancel Flag (Port 4)	Cleared	Cleared	R/W	
M8034	High-speed Counter (Group 3/I3)	Comparison Output Reset	Cleared	Cleared	R/W
M8035		Gate Input	Maintained	Cleared	R/W
M8036		Reset Input	Maintained	Cleared	R/W
M8037	— Reserved —	—	—	—	
M8040	High-speed Counter (Group 4/I4)	Comparison Output Reset	Cleared	Cleared	R/W
M8041		Gate Input	Maintained	Cleared	R/W
M8042		Reset Input	Maintained	Cleared	R/W
M8043	High-speed Counter (Group 5/I6)	Count Direction Flag	Maintained	Cleared	R/W
M8044		Comparison Output Reset	Cleared	Cleared	R/W
M8045		Gate Input	Maintained	Cleared	R/W
M8046		Reset Input	Maintained	Cleared	R/W
M8047 M8050	— Reserved —	—	—	—	

Device Address	Description	When Stopped	Power OFF	R/W
M8051	High-speed Counter (Group 2/I1)	Comparison Output Reset	Cleared	R/W
M8052		Gate Input	Maintained	R/W
M8053		Reset Input	Maintained	R/W
M8054		Comparison ON Status	Maintained	R
M8055		Overflow	Maintained	R
M8056	— Reserved —	—	—	—
M8057	High-speed Counter (Group 6/I7)	Comparison Output Reset	Cleared	R/W
M8060		Gate Input	Maintained	R/W
M8061		Reset Input	Maintained	R/W
M8062		Comparison ON Status	Maintained	R
M8063		Overflow	Maintained	R
M8064 to M8067	— Reserved —	—	—	—
M8070	SD Memory Card Mount Status	Maintained	Cleared	R
M8071	Accessing SD Memory Card	Maintained	Cleared	R
M8072	Unmount SD Memory Card	Operating	Cleared	R/W
M8073	Function Switch Status	Operating	Cleared	R
M8074	Battery Voltage Measurement Flag	Operating	Cleared	R/W
M8075 to M8077	— Reserved —	—	—	—
M8080	Data Link Slave 1 Communication Completed Relay (When Data Link Master)	Operating	Cleared	R
M8081	Data Link Slave 2 Communication Completed Relay	Operating	Cleared	R
M8082	Data Link Slave 3 Communication Completed Relay	Operating	Cleared	R
M8083	Data Link Slave 4 Communication Completed Relay	Operating	Cleared	R
M8084	Data Link Slave 5 Communication Completed Relay	Operating	Cleared	R
M8085	Data Link Slave 6 Communication Completed Relay	Operating	Cleared	R
M8086	Data Link Slave 7 Communication Completed Relay	Operating	Cleared	R
M8087	Data Link Slave 8 Communication Completed Relay	Operating	Cleared	R
M8090	Data Link Slave 9 Communication Completed Relay	Operating	Cleared	R
M8091	Data Link Slave 10 Communication Completed Relay	Operating	Cleared	R
M8092	Data Link Slave 11 Communication Completed Relay	Operating	Cleared	R
M8093	Data Link Slave 12 Communication Completed Relay	Operating	Cleared	R
M8094	Data Link Slave 13 Communication Completed Relay	Operating	Cleared	R
M8095	Data Link Slave 14 Communication Completed Relay	Operating	Cleared	R
M8096	Data Link Slave 15 Communication Completed Relay	Operating	Cleared	R
M8097	Data Link Slave 16 Communication Completed Relay	Operating	Cleared	R
M8100	Data Link Slave 17 Communication Completed Relay	Operating	Cleared	R
M8101	Data Link Slave 18 Communication Completed Relay	Operating	Cleared	R
M8102	Data Link Slave 19 Communication Completed Relay	Operating	Cleared	R
M8103	Data Link Slave 20 Communication Completed Relay	Operating	Cleared	R
M8104	Data Link Slave 21 Communication Completed Relay	Operating	Cleared	R
M8105	Data Link Slave 22 Communication Completed Relay	Operating	Cleared	R
M8106	Data Link Slave 23 Communication Completed Relay	Operating	Cleared	R
M8107	Data Link Slave 24 Communication Completed Relay	Operating	Cleared	R
M8110	Data Link Slave 25 Communication Completed Relay	Operating	Cleared	R
M8111	Data Link Slave 26 Communication Completed Relay	Operating	Cleared	R
M8112	Data Link Slave 27 Communication Completed Relay	Operating	Cleared	R
M8113	Data Link Slave 28 Communication Completed Relay	Operating	Cleared	R
M8114	Data Link Slave 29 Communication Completed Relay	Operating	Cleared	R
M8115	Data Link Slave 30 Communication Completed Relay	Operating	Cleared	R
M8116	Data Link Slave 31 Communication Completed Relay	Operating	Cleared	R
M8117	Data Link All Slaves Communication Completed Relay	Operating	Cleared	R
M8120	Initialize Pulse	Cleared	Cleared	R
M8121	1-s Clock	Operating	Cleared	R
M8122	100-ms Clock	Operating	Cleared	R

6: DEVICES

Device Address	Description	When Stopped	Power OFF	R/W	
M8123	10-ms Clock	Operating	Cleared	R	
M8124	Timer/Counter Preset Value Changed	Maintained	Cleared	R	
M8125	In-operation Output	Cleared	Cleared	R	
M8126	1 Scan ON After Run-Time Download Completes	Cleared	Cleared	R	
M8127	— Reserved —	—	—	—	
M8130	High-speed Counter (Group 1/I0)	Reset Status	Maintained	Cleared	R
M8131		Comparison ON Status	Maintained	Cleared	R
M8132	— Reserved —	—	—	—	
M8133	High-speed Counter (Group 3/I3)	Comparison ON Status	Maintained	Cleared	R
M8134	High-speed Counter (Group 4/I4)	Comparison ON Status	Maintained	Cleared	R
M8135	High-speed Counter (Group 5/I6)	Reset Status	Maintained	Cleared	R
M8136		Comparison ON Status	Maintained	Cleared	R
M8137	Interrupt Input I0 Status (Group 1/I0)	(ON: Allowed, OFF: Prohibited)	Cleared	Cleared	R
M8140	Interrupt Input I1 Status (Group 2/I1)		Cleared	Cleared	R
M8141	Interrupt Input I3 Status (Group 3/I3)		Cleared	Cleared	R
M8142	Interrupt Input I4 Status (Group 4/I4)		Cleared	Cleared	R
M8143	Interrupt Input I6 Status (Group 5/I6)		Cleared	Cleared	R
M8144	Timer Interrupt Status		Cleared	Cleared	R
M8145	User Communication Receive Instruction Cancel Flag (Port 5)	Cleared	Cleared	R/W	
M8146	User Communication Receive Instruction Cancel Flag (Port 6)	Cleared	Cleared	R/W	
M8147	User Communication Receive Instruction Cancel Flag (Port 7)	Cleared	Cleared	R/W	
M8150	Comparison Result 1	Maintained	Cleared	R	
M8151	Comparison Result 2	Maintained	Cleared	R	
M8152	Comparison Result 3	Maintained	Cleared	R	
M8153	Catch Input ON/OFF Status	Group 1/I0	Maintained	Cleared	R
M8154		Group 2/I1	Maintained	Cleared	R
M8155		Group 3/I3	Maintained	Cleared	R
M8156		Group 4/I4	Maintained	Cleared	R
M8157		Group 5/I6	Maintained	Cleared	R
M8160		Group 6/I7	Maintained	Cleared	R
M8161	High-speed Counter (Group 1/I0)	Overflow	Maintained	Cleared	R
M8162		Underflow	Maintained	Cleared	R
M8163	High-speed Counter (Group 5/I6)	Overflow	Maintained	Cleared	R
M8164		Underflow	Maintained	Cleared	R
M8165	High-speed Counter (Group 3/I3)	Overflow	Maintained	Cleared	R
M8166	High-speed Counter (Group 4/I4)	Overflow	Maintained	Cleared	R
M8167	Interrupt Input I7 Status (Group 6/I7)	(ON: Allowed, OFF: Prohibited)	Maintained	Cleared	R
M8170	User Communication Receive Instruction Cancel Flag (Port 8)	Cleared	Cleared	R/W	
M8171	— Reserved —	—	—	—	
M8172	Transistor Source Output Overcurrent Detection	Group 1	Operating	Cleared	R
M8173		Group 2	Operating	Cleared	R
M8174		Group 3	Operating	Cleared	R
M8175		Group 4	Operating	Cleared	R
M8176	User Communication Receive Instruction Cancel Flag (Port 9)	Cleared	Cleared	R/W	
M8177 to M8183	— Reserved —	—	—	—	
M8184	Change HMI Module Network Settings Trigger	Operating	Cleared	R/W	
M8185	In Daylight Saving Time Period	Operating	Cleared	R	
M8186	Ethernet Port 1 Executing Auto Ping	Operating	Cleared	R	
M8187	Ethernet Port 1 Auto Ping Stop Flag	Operating	Cleared	R/W	
M8190	Change CPU Module Ethernet Port 1 Network Settings Trigger	Operating	Cleared	R/W	
M8191	SNTP Acquisition Flag	Operating	Cleared	R/W	

Device Address	Description	When Stopped	Power OFF	R/W
M8192	Interrupt Input I0 Edge	On: Rising Edge Off: Falling Edge	Cleared	R
M8193	Interrupt Input I3 Edge		Cleared	R
M8194	Interrupt Input I4 Edge		Cleared	R
M8195	Interrupt Input I6 Edge		Cleared	R
M8196	Interrupt Input I7 Edge		Cleared	R
M8197	Interrupt Input I1 Edge		Cleared	R
M8200	User Communication Receive Instruction Cancel Flag	Connection 1	Cleared	R/W
M8201		Connection 2	Cleared	R/W
M8202		Connection 3	Cleared	R/W
M8203		Connection 4	Cleared	R/W
M8204		Connection 5	Cleared	R/W
M8205		Connection 6	Cleared	R/W
M8206		Connection 7	Cleared	R/W
M8207		Connection 8	Cleared	R/W
M8210	— Reserved —	—	—	—
M8211	HMI Module Send E-mail Server Settings Initialization	Operating	Cleared	R/W
M8212	Connection Status (ON: Connected, OFF: Not Connected)	Connection 1	Operating	R
M8213		Connection 2	Operating	R
M8214		Connection 3	Operating	R
M8215		Connection 4	Operating	R
M8216		Connection 5	Operating	R
M8217		Connection 6	Operating	R
M8220		Connection 7	Operating	R
M8221		Connection 8	Operating	R
M8222	Disconnect User Communication Connection	Connection 1	Operating	R/W
M8223		Connection 2	Operating	R/W
M8224		Connection 3	Operating	R/W
M8225		Connection 4	Operating	R/W
M8226		Connection 5	Operating	R/W
M8227		Connection 6	Operating	R/W
M8230		Connection 7	Operating	R/W
M8231		Connection 8	Operating	R/W
M8232	HMI Module Connection Information Reference Connection Status	Operating	Cleared	R
M8233 to M8247	— Reserved —	—	—	—
M8250	Download from SD Memory Card Execution Flag	Operating	Cleared	R/W
M8251	Upload to SD Memory Card Execution Flag	Operating	Cleared	R/W
M8252	Executing SD Memory Card Download	Operating	Cleared	R
M8253	Executing SD Memory Card Upload	Operating	Cleared	R
M8254	SD Memory Card Download/Upload Execution Completion Output	Operating	Cleared	R
M8255	SD Memory Card Download/Upload Execution Error Output	Operating	Cleared	R
M8256 M8257	— Reserved —	—	—	—
M8260	Write Recipe Execution Flag	Operating	Cleared	R/W
M8261	Read Recipe Execution Flag	Operating	Cleared	R/W
M8262	Executing Write Recipe	Operating	Cleared	R/W
M8263	Executing Read Recipe	Operating	Cleared	R/W
M8264	Recipe Channel Execution Completed Output	Operating	Cleared	R/W
M8265	Recipe Execution Error Output	Operating	Cleared	R/W
M8266	Recipe Block Execution Completed Output	Operating	Cleared	R/W
M8267	Read Restriction for Recipe Internal Memory (ROM-Range)	Operating	Cleared	R
M8270	— Reserved —	—	—	—
M8271	Download MQTT Basic Settings from SD Memory Card Execution Flag	Operating	Cleared	R/W
M8272	Download MQTT Basic Settings from SD Memory Card Execution Completion Output	Operating	Cleared	R

6: DEVICES

Device Address	Description	When Stopped	Power OFF	R/W	
M8273	Download MQTT Basic Settings from SD Memory Card Error Output	Operating	Cleared	R	
M8274 to M8297	— Reserved —	—	—	—	
M8300	J1939 Communication Permitted Flag	Cleared	Cleared	R/W	
M8301	J1939 Online Status	Cleared	Cleared	R	
M8302	J1939 Local Station Address Confirmation Status	Cleared	Cleared	R	
M8303	J1939 Communication Error Output	Cleared	Cleared	R	
M8304	J1939 Communication Bus Off Occurrence Output	Cleared	Cleared	R	
M8305 to M8310	— Reserved —	—	—	—	
M8311	ESC+Key Input (Up)	ESC+Key Input (↕)	Cleared	Cleared	R
M8312	ESC+Key Input (Down)	ESC+Key Input (↕)	Cleared	Cleared	R
M8313	ESC+Key Input (Left)	ESC+Key Input (↔)	Cleared	Cleared	R
M8314	ESC+Key Input (Right)	ESC+Key Input (↔)	Cleared	Cleared	R
M8315 to M8319	— Reserved —	—	—	—	
M8320	Initialize Expansion Interface Remote Master/Slave	Operating	Cleared	R/W	
M8321 to M8330	— Reserved —	—	—	—	
M8331	Ethernet Port 2 Executing Auto Ping	Operating	Cleared	R	
M8332	Ethernet Port 2 Auto Ping Stop Flag	Operating	Cleared	R/W	
M8333	Change CPU Module Ethernet Port 2 Network Settings Trigger	Operating	Cleared	R/W	
M8334	User Communication Receive Instruction Cancel Flag	Connection 9	Cleared	Cleared	R/W
M8335		Connection 10	Cleared	Cleared	R/W
M8336		Connection 11	Cleared	Cleared	R/W
M8337		Connection 12	Cleared	Cleared	R/W
M8340		Connection 13	Cleared	Cleared	R/W
M8341		Connection 14	Cleared	Cleared	R/W
M8342		Connection 15	Cleared	Cleared	R/W
M8343		Connection 16	Cleared	Cleared	R/W
M8344	Ethernet Port 1 Send E-mail Server Settings Initialization	Operating	Cleared	R/W	
M8345	Connection Status (ON: Connected, OFF: Not Connected)	Connection 9	Operating	Cleared	R
M8346		Connection 10	Operating	Cleared	R
M8347		Connection 11	Operating	Cleared	R
M8350		Connection 12	Operating	Cleared	R
M8351		Connection 13	Operating	Cleared	R
M8352		Connection 14	Operating	Cleared	R
M8353		Connection 15	Operating	Cleared	R
M8354		Connection 16	Operating	Cleared	R
M8355	Disconnect User Communication Connection	Connection 9	Operating	Cleared	R/W
M8356		Connection 10	Operating	Cleared	R/W
M8357		Connection 11	Operating	Cleared	R/W
M8360		Connection 12	Operating	Cleared	R/W
M8361		Connection 13	Operating	Cleared	R/W
M8362		Connection 14	Operating	Cleared	R/W
M8363		Connection 15	Operating	Cleared	R/W
M8364		Connection 16	Operating	Cleared	R/W
M8365	User Communication Receive Instruction Cancel Flag (Port 10)	Cleared	Cleared	R/W	
M8366	User Communication Receive Instruction Cancel Flag (Port 11)	Cleared	Cleared	R/W	
M8367	User Communication Receive Instruction Cancel Flag (Port 12)	Cleared	Cleared	R/W	
M8370	User Communication Receive Instruction Cancel Flag (Port 13)	Cleared	Cleared	R/W	
M8371	User Communication Receive Instruction Cancel Flag (Port 14)	Cleared	Cleared	R/W	
M8372	User Communication Receive Instruction Cancel Flag (Port 15)	Cleared	Cleared	R/W	
M8373	User Communication Receive Instruction Cancel Flag (Port 16)	Cleared	Cleared	R/W	
M8374	User Communication Receive Instruction Cancel Flag (Port 17)	Cleared	Cleared	R/W	

Device Address	Description	When Stopped	Power OFF	R/W	
M8375	User Communication Receive Instruction Cancel Flag (Port 18)	Cleared	Cleared	R/W	
M8376	User Communication Receive Instruction Cancel Flag (Port 19)	Cleared	Cleared	R/W	
M8377	User Communication Receive Instruction Cancel Flag (Port 20)	Cleared	Cleared	R/W	
M8380	User Communication Receive Instruction Cancel Flag (Port 21)	Cleared	Cleared	R/W	
M8381	User Communication Receive Instruction Cancel Flag (Port 22)	Cleared	Cleared	R/W	
M8382	User Communication Receive Instruction Cancel Flag (Port 23)	Cleared	Cleared	R/W	
M8383	User Communication Receive Instruction Cancel Flag (Port 24)	Cleared	Cleared	R/W	
M8384	User Communication Receive Instruction Cancel Flag (Port 25)	Cleared	Cleared	R/W	
M8385	User Communication Receive Instruction Cancel Flag (Port 26)	Cleared	Cleared	R/W	
M8386	User Communication Receive Instruction Cancel Flag (Port 27)	Cleared	Cleared	R/W	
M8387	User Communication Receive Instruction Cancel Flag (Port 28)	Cleared	Cleared	R/W	
M8390	User Communication Receive Instruction Cancel Flag (Port 29)	Cleared	Cleared	R/W	
M8391	User Communication Receive Instruction Cancel Flag (Port 30)	Cleared	Cleared	R/W	
M8392	User Communication Receive Instruction Cancel Flag (Port 31)	Cleared	Cleared	R/W	
M8393	User Communication Receive Instruction Cancel Flag (Port 32)	Cleared	Cleared	R/W	
M8394	User Communication Receive Instruction Cancel Flag (Port 33)	Cleared	Cleared	R/W	
M8395 to M8447	— Reserved —	—	—	—	
M8450	BACnet Communication Bit	Operating	Cleared	R/W	
M8451 to M8457	— Reserved —	—	—	—	
M8460	EtherNet/IP Communication Bit	Cleared	Cleared	R/W	
M8461 to M8597	— Reserved —	—	—	—	
M8600	High-speed Counter (Group 3/13)	Reset Status	Maintained	Cleared	R
M8601		Underflow	Maintained	Cleared	R
M8602		Count Direction Flag	Maintained	Cleared	R
M8603 to M8997	— Reserved —	—	—	—	

Supplementary Descriptions of the Special Internal Relays

■ M8000: Start Control

M8000 controls the run/stop status of the FC6A Series MICROSmart. The CPU is set to run when M8000 is turned on, and the CPU is set to off when M8000 is turned off. See "Start/Stop Operation" on page 4-18. However, the function switch, stop input, and reset input have precedence over start control. M8000 maintains its status when the CPU is powered down. When data to be maintained during a power failure disappears after the CPU has been off for a period longer than the battery backup duration, the CPU restarts operation as selected in Configuration > Run/Stop Control > Run/Stop Selection at Keep Data Error. For details, see "Run/Stop Selection at Keep Data Error" on page 5-9.

■ M8001: 1-s Clock Reset

While M8001 is on, M8121 (1-s clock) is always off.

■ M8002: All Outputs OFF

While M8002 is on, all outputs are off. The self-holding circuit created in the ladder program is also off.

■ M8003: Carry/Borrow

When a carry (Cy) or borrow (Bw) results from executing an addition or subtraction instruction, M8003 is turned on. For details, see "Carry and Borrow" on page 8-10".

■ M8004: User Program Execution Error

When an error occurs while executing a user program, M8004 is turned on. For details on user program execution errors, see "User Program Execution Error" on page 13-6.

■ M8005: Communication Error

When an error occurs during data link communication, M8005 is turned on. The state is retained even when the error is cleared.

■ M8006: Communication Prohibited Flag (When Data Link Master)

During data link communication, communication is stopped while M8006 is on.

■ M8007: Initialization Flag (When Data Link Master)/Stop Communication Flag (When Data Link Slave)

When data link master: When this flag is turned on in the run status, the data link is initialized just once to check the connection status. Use this when the slave configured in the data link is powered at a timing slower than the master.

When data link slave : This flag is turned on when communication from the master is interrupted for 10 s or longer. This flag is turned off when communication can be normally received.

■ M8010: Status LED Operation

While M8010 is on, the status LED [STAT] is turned on. While off, the status LED [STAT] is turned off.

■ M8013: Calendar/Clock Data Write/Adjust Error Flag

When the clock writing or clock adjustment processing could not be executed normally, M8013 is turned on. It is turned off when the processing completes normally.

■ M8014: Calendar/Clock Data Read Error Flag

When an error occurs while calendar/clock data is read from the internal clock to the special data registers (D8008 to D8021), M8014 is turned on. It is turned off when reading completes normally.

■ M8016: Calendar Data Write Flag

When M8016 is turned on after writing data to the calendar data (write-only) special data registers (D8015 to D8018), the calendar data (year, month, day, day of the week) is written to the internal clock.

■ M8017: Clock Data Write Flag

When M8017 is turned on after writing data to the clock data (write-only) special data registers (D8019 to D8021), the clock data (hours, minutes, seconds) is written to the internal clock.

■ M8020: Calendar/Clock Data Write Flag

When M8020 is turned on after writing data to the calendar/clock data (write-only) special data registers (D8015 to D8021), the calendar data (year, month, day, day of the week) and the clock data (hours, minutes, seconds) is written to the internal clock.

■ M8021: Clock Data Adjust Flag

When M8021 is turned on, the clock is adjusted with respect to seconds.

- When M8021 is turned on, if the seconds are between 0 and 29, the seconds will be set to 0 and the minutes remain the same.
- When M8021 is turned on, if the seconds are between 30 and 59, the seconds will be set to 0 and 1 will be added to the minutes.

■ M8022: User Communication Receive Instruction Cancel Flag (Port 1)

While M8022 is on, user communication (receive instruction) executing on Port 1 is canceled.

■ M8023: User Communication Receive Instruction Cancel Flag (Port 2)

While M8023 is on, user communication (receive instruction) executing on Port 2 is canceled.

■ M8024: BMOV/WSFT Executing Flag

While the WSFT (word shift) instruction or the BMOV (block move) instruction is executing, M8024 is turned on. When completed, M8024 is turned off.

■ M8025: Maintain Outputs While Stopped

When the FC6A Series MICROSmart is stopped while running with M8025 turned on, the outputs maintain their runtime status. When set to run again, M8025 is automatically turned off.

■ M8026: User Communication Receive Instruction Cancel Flag (Port 3)

While M8026 is on, user communication (receive instruction) executing on Port 3 is canceled.

■ M8033, M8145 to M8147, M8170, M8176, M8365 to M8394: User Communication Receive Instruction Cancel Flag (Port 4 to 33)

While these flags are on, user communication (receive instruction) being executed on the corresponding port is canceled.

M8033 = User Communication Receive Instruction Cancel Flag (Port 4)

M8145 = User Communication Receive Instruction Cancel Flag (Port 5)

M8146 = User Communication Receive Instruction Cancel Flag (Port 6)

M8147 = User Communication Receive Instruction Cancel Flag (Port 7)

M8170 = User Communication Receive Instruction Cancel Flag (Port 8)

M8176 = User Communication Receive Instruction Cancel Flag (Port 9)

M8365 = User Communication Receive Instruction Cancel Flag (Port 10)

M8366 = User Communication Receive Instruction Cancel Flag (Port 11)

M8367 = User Communication Receive Instruction Cancel Flag (Port 12)

M8370 = User Communication Receive Instruction Cancel Flag (Port 13)
 M8371 = User Communication Receive Instruction Cancel Flag (Port 14)
 M8372 = User Communication Receive Instruction Cancel Flag (Port 15)
 M8373 = User Communication Receive Instruction Cancel Flag (Port 16)
 M8374 = User Communication Receive Instruction Cancel Flag (Port 17)
 M8375 = User Communication Receive Instruction Cancel Flag (Port 18)
 M8376 = User Communication Receive Instruction Cancel Flag (Port 19)
 M8377 = User Communication Receive Instruction Cancel Flag (Port 20)
 M8380 = User Communication Receive Instruction Cancel Flag (Port 21)
 M8381 = User Communication Receive Instruction Cancel Flag (Port 22)
 M8382 = User Communication Receive Instruction Cancel Flag (Port 23)
 M8383 = User Communication Receive Instruction Cancel Flag (Port 24)
 M8384 = User Communication Receive Instruction Cancel Flag (Port 25)
 M8385 = User Communication Receive Instruction Cancel Flag (Port 26)
 M8386 = User Communication Receive Instruction Cancel Flag (Port 27)
 M8387 = User Communication Receive Instruction Cancel Flag (Port 28)
 M8390 = User Communication Receive Instruction Cancel Flag (Port 29)
 M8391 = User Communication Receive Instruction Cancel Flag (Port 30)
 M8392 = User Communication Receive Instruction Cancel Flag (Port 31)
 M8393 = User Communication Receive Instruction Cancel Flag (Port 32)
 M8394 = User Communication Receive Instruction Cancel Flag (Port 33)

■ **M8027 to M8032, M8034 to M8036, M8040 to M8046, M8051 to M8055, M8057 to M8063, M8130, M8131, M8133 to M8136, M8161 to M8167, M8600 to M8602: Special Internal Relays for High-speed Counter**

Special internal relays used for the high-speed counter. For details, see "High-Speed Counter" on page 5-15.

M8027 to M8032, M8130, M8131, M8161, M8162 = High-speed counter (group 1/I0)
 M8034 to M8036, M8133, M8165, M8600 to M8602 = High-speed counter (group 3/I3)
 M8040 to M8042, M8134, M8166 = High-speed counter (group 4/I4)
 M8043 to M8046, M8135, M8136, M8163, M8164 = High-speed counter (group 5/I6)
 M8051 to M8055 = High-speed counter (group 2/I1)
 M8057 to M8063 = High-speed counter (group 6/I7)

■ **M8070: SD Memory Card Mount Status**

When an SD memory card is inserted in the FC6A Series MICROSmart and it has been recognized and can be used, M8070 is turned on. M8070 is turned off if no SD memory card has been inserted or if it is not recognized.

■ **M8071: Accessing SD Memory Card**

M8071 is turned on while the SD memory card is being accessed. It is turned off when access has finished.

■ **M8072: Unmount SD Memory Card**

When M8072 is turned on, access to the SD memory card is stopped. To make an SD memory card accessible that has had access to it stopped, insert the card once again.

■ **M8073: Function Switch Status**

This relay indicates the status of the function switch on the front of the CPU module.
 M8073 is on when the function switch is 1. M8073 is off when the function switch is 0.

■ **M8074: Battery Voltage Measurement Flag**

This relay indicates the battery voltage measurement status of the backup battery.
 When M8074 is turned on, the battery voltage starts being measured, and it is turned off when the measurement has finished.

■ **M8080 to M8117: Data Link Communication Completed Relay**

Special internal relays used for data link communication. For details, see Chapter 7 "Data Link Communication" in the "FC6A Series MICROSmart Communication Manual".

■ **M8120: Initialize Pulse**

When operation (RUN) starts, M8120 is turned on for a period of one scan.

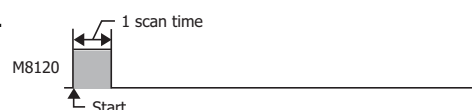

■ **M8121: 1-s Clock**

While M8001 is off, M8121 generates clock pulses in a 1 s cycle, with a duty ratio of 1:1 (500 ms on and 500 ms off).

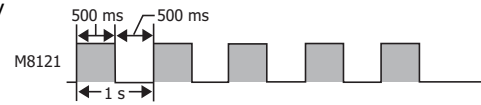

■ **M8122: 100-ms Clock**

M8122 generates clock pulses in a 100 ms cycle, with a duty ratio of 1:1 (50 ms on and 50 ms off).

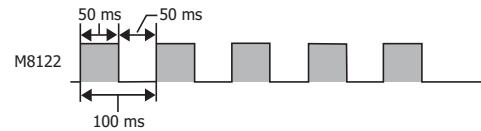

■ **M8123: 10-ms Clock**

M8123 generates clock pulses in a 10 ms cycle, with a duty ratio of 1:1 (5 ms on and 5 ms off).

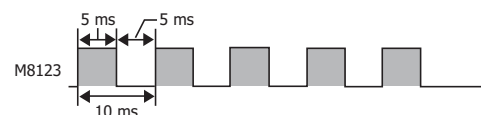

■ **M8124: Timer/Counter Preset Value Changed**

When timer or counter preset values are changed, M8124 is turned on. When a user program is transferred or when the changed data is cleared, M8124 is turned off.

■ **M8125: In-operation Output**

M8125 is on during the run status.

■ **M8126: Scan ON After Run-Time Download Completes**

When the user program is changed during the run status (run-time download), after the download completes, M8126 is turned on for one scan only when the user program starts operation.

■ **M8137 to M8143, M8167: Interrupt Input Status**

These relays are turned on when the corresponding user interrupt is allowed. These relays are turned off when the user interrupt is prohibited.

- M8137 = Interrupt input I0 status
- M8140 = Interrupt input I1 status
- M8141 = Interrupt input I3 status
- M8142 = Interrupt input I4 status
- M8143 = Interrupt input I6 status
- M8167 = Interrupt input I7 status

■ **M8144: Timer Interrupt Status**

When the timer interrupt is allowed, M8144 is turned on. When the timer interrupt is prohibited, M8144 is turned off.

■ **M8150 to M8152: Comparison Result**

M8150 to M8152 turn on according to the comparison results of the CMP= (Compare(=)) instruction and the ICMP>= (Interval Compare) instruction.

For details, see Chapter 6 "Special Internal Relays M8150, M8151, and M8152 in ICMP>=" in the "FC6A Series MICROSmart Ladder Programming Manual".

■ **M8153 to M8160: Catch Input ON/OFF Status**

When the rising or falling input edge of the input contact specified as the catch input is detected during a scan, the input contact status is captured. The detectable edges are once per scan.

- M8153 = Group 1/I0 status
- M8154 = Group 2/I1 status
- M8155 = Group 3/I3 status
- M8156 = Group 4/I4 status
- M8157 = Group 5/I6 status
- M8160 = Group 6/I7 status

■ **M8172 to M8175: Transistor Source Output Overcurrent Detection**

When overcurrent output occurs in a transistor protection source output on the CPU module, a special internal relay (M8172 to M8175) is turned on. The following special internal relays have been allocated with four outputs set as one group. If overcurrent output occurs in any of the special internal relays, it is turned on.

Even if the overcurrent output has been cleared, these special internal relays are not reset to off. To reset a special internal relay to off, create programming to do so in the ladder program.

M8172 = Group 1 (Q0 to Q3) status

M8173 = Group 2 (Q4 to Q7) status

M8174 = Group 3 (Q10 to Q13) status

M8175 = Group 4 (Q14 to Q17) status

■ **M8184: Change HMI Module Network Settings Trigger**

When M8184 is turned on, the values stored in D8437 to D8456 are set as the HMI module IP address.

The IP address is not set just by changing the values of D8437 to D8456. For details on changing the HMI module network settings, see Chapter 3 "Network settings by HMI module special data registers" in the "FC6A Series MICROSmart Communication Manual".

■ **M8185: In Daylight Saving Time Period**

When the daylight saving time function is enabled, M8185 is on during the daylight saving time period. When outside of the daylight saving time period, M8185 is off.

When the daylight saving time function is disabled, M8185 is off.

■ **M8186: Ethernet Port 1 Executing Auto Ping**

M8186 is on when the auto ping on Ethernet port 1 is operating. M8186 is off when auto ping is stopped. For details on auto ping, see Chapter 3 "Auto Ping Function" in the "FC6A Series MICROSmart Communication Manual".

■ **M8187: Ethernet Port 1 Auto Ping Stop Flag**

While M8187 is on, the auto ping on Ethernet port 1 is stopped. While M8187 is off, auto ping is executed. At that time, auto ping is executed from the smallest remote host number specified in the remote host list, regardless of the previous end status.

■ **M8190: Change CPU Module Ethernet Port 1 Network Settings Trigger**

When M8190 is turned on, the values stored in D8303 to D8323 are set as the IP Settings/DNS Settings of Ethernet port 1 on the CPU module.

The IP address is not set just by changing the values of D8303 to D8323. For details on changing the IP Settings/DNS Settings of Ethernet port 1 on the CPU module, see Chapter 3 "Network settings by special data registers" in the "FC6A Series MICROSmart Communication Manual".

■ **M8191: SNTP Acquisition Flag**

When M8191 is turned on, the time information is acquired from the SNTP server.

■ **M8192 to M8197: Interrupt Input Edge**

These relays turn on when an interrupt occurs with the rising edge of an interrupt input. They turn off when an interrupt occurs with the falling edge of an interrupt input.

M8192 = Interrupt input I0 edge

M8193 = Interrupt input I3 edge

M8194 = Interrupt input I4 edge

M8195 = Interrupt input I6 edge

M8196 = Interrupt input I7 edge

M8197 = Interrupt input I1 edge

■ **M8200 to M8207, M8334 to M8343: User Communication Receive Instruction Cancel Flag**

When M8200 to M8207 or M8334 to M8343 are turned on, the user communication receive instruction being executed is stopped.

M8200 = User communication receive instruction being executed on client connection 1

M8201 = User communication receive instruction being executed on client connection 2

M8202 = User communication receive instruction being executed on client connection 3

M8203 = User communication receive instruction being executed on client connection 4

M8204 = User communication receive instruction being executed on client connection 5

M8205 = User communication receive instruction being executed on client connection 6

M8206 = User communication receive instruction being executed on client connection 7

M8207 = User communication receive instruction being executed on client connection 8

M8334 = User communication receive instruction being executed on client connection 9

M8335 = User communication receive instruction being executed on client connection 10

M8336 = User communication receive instruction being executed on client connection 11

M8337 = User communication receive instruction being executed on client connection 12

M8340 = User communication receive instruction being executed on client connection 13

M8341 = User communication receive instruction being executed on client connection 14

M8342 = User communication receive instruction being executed on client connection 15

M8343 = User communication receive instruction being executed on client connection 16

■ **M8211: HMI Module Send E-mail Server Settings Initialization**

When M8211 is turned on, the settings for the send E-mail server on the HMI-Ethernet port are initialized.

■ **M8212 to M8221, M8345 to M8354: Connection Status**

While connected to a network device via the maintenance communication server, user communication server/client, or Modbus TCP server/client, the connection status is turned on. While not connected to a network device, the connection status is turned off.

M8212 = Connection 1

M8213 = Connection 2

M8214 = Connection 3

M8215 = Connection 4

M8216 = Connection 5

M8217 = Connection 6

M8220 = Connection 7

M8221 = Connection 8

M8345 = Connection 9

M8346 = Connection 10

M8347 = Connection 11

M8350 = Connection 12

M8351 = Connection 13

M8352 = Connection 14

M8353 = Connection 15

M8354 = Connection 16

■ **M8222 to M8231, M8355 to M8364: Disconnect User Communication Connection**

When connected to a remote host via user communication, the corresponding connection is disconnected when M8222 to M8231 is turned on.

M8222 = Connection 1

M8223 = Connection 2

M8224 = Connection 3

M8225 = Connection 4

M8226 = Connection 5

M8227 = Connection 6

M8230 = Connection 7

M8231 = Connection 8

M8355 = Connection 9

M8356 = Connection 10

M8357 = Connection 11

M8360 = Connection 12

M8361 = Connection 13

M8362 = Connection 14

M8363 = Connection 15

M8364 = Connection 16

These relays are enabled only when a user communication client is used.

■ **M8232: HMI Module Connection Information Reference Connection Status**

M8232 is turned on when there is a connection with the connection number specified by D8429. M8232 is turned off when there is no connection.

■ **M8250: Download from SD Memory Card Execution Flag**

When M8250 is turned on, a ZLD file is downloaded from the SD memory card. The file that will be downloaded is the ZLD file specified in the autoexec.ini file.

■ **M8251: Upload to SD Memory Card Execution Flag**

When M8251 is turned on, a ZLD file is uploaded to the SD memory card.

A ZLD file is created with the file name specified in the autoexec.ini file.

- **M8252: Executing SD Memory Card Download**
M8252 is turned on when starting execution of the download from the SD memory card, and when the download has completed, it is turned off.
- **M8253: Executing SD Memory Card Upload**
M8253 is turned on when starting execution of the upload to the SD memory card, and when the upload has completed, it is turned off.
- **M8254: SD Memory Card Download/Upload Execution Completed Output**
M8254 is turned off when starting execution of the download from the SD memory card or the upload to the SD memory card, and when the download or upload has completed, it is turned on.
- **M8255: SD Memory Card Download/Upload Execution Error Output**
M8255 is updated when execution of the download from the SD memory card or the upload to the SD memory card has completed. M8255 is turned on when D8255 (Download/Upload Execution Status) is a value other than 0.
- **M8260: Write Recipe Execution Flag**
When M8260 is turned on, write recipe is executed.
- **M8261: Read Recipe Execution Flag**
When M8261 is turned on, read recipe is executed.
- **M8262: Executing Write Recipe**
M8262 is turned on when the write recipe processing starts, and it is turned off when the processing has completed. M8262 also is turned off when read recipe processing starts.
- **M8263: Executing Read Recipe**
M8263 is turned on when the read recipe processing starts, and it is turned off when the processing has completed. M8263 also is turned off when write recipe processing starts.
- **M8264: Recipe Channel Execution Completed Output**
M8264 is turned off when starting to read or write a recipe channel, and it is turned on when reading or writing a recipe channel has completed.
- **M8265: Recipe Execution Error Output**
M8265 is turned on when recipe execution has completed and D8264 (Recipe Execution Status) is a value other than 0. For details on recipes, see "Recipe Function" on page 11-8.
- **M8266: Recipe Block Execution Completed Output**
M8266 is turned off when starting to read or write a recipe block, and it is turned on when reading or writing a recipe block has completed.
- **M8267: Read Restriction for Recipe Internal Memory (ROM-Range)**
M8267 is turned on when reading or writing to a recipe block in internal memory (ROM-Range) has completed. When M8267 is on, recipes cannot be read to internal memory (ROM-Range 1) and internal memory (ROM-Range 2). When reading recipes, turn off M8267.
- **M8271: Download MQTT Basic Settings from SD Memory Card Execution Flag**
When M8271 is turned on, the files for MQTT Basic Settings are downloaded. For details on the files for MQTT Basic Settings, see "SD Memory Card Folder Structure and Files" on page 11-4.
- **M8272: Download MQTT Basic Settings from SD Memory Card Execution Completion Output**
M8272 is turned off when downloading the files for MQTT Basic Settings is started, and it is turned on once the download is finished.
- **M8273: Download MQTT Basic Settings from SD Memory Card Error Output**
M8273 is turned off when downloading the files for MQTT Basic Settings is started, and it is turned on if an error occurs during the process.
- **M8300 to M8304: J1939 Communication**
Special internal relays used in J1939 communication. For details, see Chapter 8 "J1939 Communication" in the "FC6A Series MICROSmart Communication Manual".

■ **M8311 to M8314: Key Input Status**

While the ESC button and direction buttons on the HMI module are simultaneously pressed, the corresponding special internal relays are turned on. When the keys are not pressed, the relays are turned off.

M8311 = ESC key + Up (⬆) key

M8312 = ESC key + Down (⬇) key

M8313 = ESC key + Left (⬅) key

M8314 = ESC key + Right (➡) key

■ **M8320: Initialize Expansion Interface Remote Master/Slave**

When M8320 is turned on, expansion interface remote master and slave modules along with the expansion modules that are connected to the expansion interface remote slave modules are initialized. Once the initialization is finished, M8320 is automatically turned off and the I/O refresh at the expansion interface remote slave modules will resume.

■ **M8331: Ethernet Port 2 Executing Auto Ping**

M8331 is on when the auto ping on Ethernet port 2 is operating. M8331 is off when auto ping is stopped. For details on auto ping, see Chapter 3 "Auto Ping Function" in the "FC6A Series MICROSmart Communication Manual".

■ **M8332: Ethernet Port 2 Auto Ping Stop Flag**

While M8332 is on, the auto ping on Ethernet port 2 is stopped. While M8332 is off, auto ping is executed. At that time, auto ping is executed from the smallest remote host number specified in the remote host list, regardless of the previous end status.

■ **M8333: Change CPU Module Ethernet Port 2 Network Settings Trigger**

When M8333 is turned on, the values stored in D8630 to D8650 are set as the IP Settings/DNS Settings of Ethernet port 2 on the CPU module. The IP address is not set just by changing the values of D8630 to D8650. For details on changing the IP Settings/DNS Settings of Ethernet port 2 on the CPU module, see Chapter 3 "Network settings by special data registers" in the "FC6A Series MICROSmart Communication Manual".

■ **M8344: Ethernet Port 1 Send E-mail Server Settings Initialization**

When M8344 is turned on, the settings for the send E-mail server on the Ethernet port 1 are initialized.

■ **M8450: BACnet Communication Bit**

While M8450 is on, BACnet communication will be performed.

■ **M8460: EtherNet/IP Communication Bit**

This special internal relay permits or prohibits EtherNet/IP communication.

OFF: Prohibit EtherNet/IP communication

ON: Permit EtherNet/IP communication

Special Data Register

Special Data Register Device Addresses



Warning

Do not write to data in the area marked as reserved in the special data registers list. Otherwise the system may not operate correctly.

Note: R/W is an abbreviation for read/write.

The notation for the R/W field is as follows.

R/W: The device can be both read from and written to

R: Read-only

W: Write-only

Device Address	Description	Update Timing	R/W
D8000	Quantity of Inputs	When I/O initialized	R
D8001	Quantity of Outputs	When I/O initialized	R
D8002	CPU Module Type Information	Power-up	R
D8003 D8004	— Reserved —	—	-
D8005	General Error Code	When error occurred	R/W
D8006	User Program Execution Error Code	When error occurred	R
D8007	— Reserved —	—	-
D8008	Calendar/Clock Current Data (Read only)	Year	Every 500 ms
D8009		Month	Every 500 ms
D8010		Day	Every 500 ms
D8011		Day of the Week	Every 500 ms
D8012		Hour	Every 500 ms
D8013		Minute	Every 500 ms
D8014		Second	Every 500 ms
D8015		Calendar/Clock New Data (Write only)	Year
D8016	Month		—
D8017	Day		—
D8018	Day of the Week		—
D8019	Hour		—
D8020	Minute		—
D8021	Second		—
D8022	Scan Time Data		Constant Scan Time Preset Value (1 to 1,000 ms)
D8023		Scan Time Current Value (ms)	Every scan
D8024		Scan Time Maximum Value (ms)	At occurrence
D8025		Scan Time Minimum Value (ms)	At occurrence
D8026	Communication Mode Information (Port 1 to Port 3)	Every scan	R
D8027 D8028	— Reserved —	—	-
D8029	System Software Version	Power-up	R
D8030	Communication Cartridge Information	Power-up	R
D8031	Optional Device Connection Information	Power-up	R
D8032	Interrupt Input Jump Destination Label No. (I1)	—	R/W
D8033	Interrupt Input Jump Destination Label No. (I3)	—	R/W
D8034	Interrupt Input Jump Destination Label No. (I4)	—	R/W
D8035	Interrupt Input Jump Destination Label No. (I6)	—	R/W
D8036	Timer Interrupt Jump Destination Label No.	—	R/W
D8037	Number of Connected I/O Modules	When I/O initialized	R
D8038 D8039	— Reserved —	—	—
D8040	Slave Number (Port 4)	—	R/W
D8041	Slave Number (Port 5)	—	R/W
D8042	Slave Number (Port 6)	—	R/W
D8043	Slave Number (Port 7)	—	R/W

6: DEVICES

Device Address	Description	Update Timing	R/W
D8044	Slave Number (Port 8)	—	R/W
D8045	Slave Number (Port 9)	—	R/W
D8046 to D8051	— Reserved —	—	—
D8052	J1939 Communication Error Code	Every scan	R/W
D8053 to D8055	— Reserved —	—	—
D8056	Battery Voltage	—	R
D8057	Analog Volume (AI0)	Every scan	R
D8058	Built-in Analog Input (AI1)	Every scan	R
D8059	Analog Input Status AI0	Every scan	R
D8060	Analog Input Status AI1	Every scan	R
D8061 to D8066	— Reserved —	—	—
D8067	Backlight ON Time	—	R/W
D8068	— Reserved —	—	—
D8069	Slave 1 Communication Status/Error (When Data Link Master Mode) Slave Communication Status/Error (When Data Link Slave Mode)	When error occurred	R
D8070	Slave 2 Communication Status/Error (When Data Link Master Mode)	When error occurred	R
D8071	Slave 3 Communication Status/Error (When Data Link Master Mode)	When error occurred	R
D8072	Slave 4 Communication Status/Error (When Data Link Master Mode)	When error occurred	R
D8073	Slave 5 Communication Status/Error (When Data Link Master Mode)	When error occurred	R
D8074	Slave 6 Communication Status/Error (When Data Link Master Mode)	When error occurred	R
D8075	Slave 7 Communication Status/Error (When Data Link Master Mode)	When error occurred	R
D8076	Slave 8 Communication Status/Error (When Data Link Master Mode)	When error occurred	R
D8077	Slave 9 Communication Status/Error (When Data Link Master Mode)	When error occurred	R
D8078	Slave 10 Communication Status/Error (When Data Link Master Mode)	When error occurred	R
D8079	Slave 11 Communication Status/Error (When Data Link Master Mode)	When error occurred	R
D8080	Slave 12 Communication Status/Error (When Data Link Master Mode)	When error occurred	R
D8081	Slave 13 Communication Status/Error (When Data Link Master Mode)	When error occurred	R
D8082	Slave 14 Communication Status/Error (When Data Link Master Mode)	When error occurred	R
D8083	Slave 15 Communication Status/Error (When Data Link Master Mode)	When error occurred	R
D8084	Slave 16 Communication Status/Error (When Data Link Master Mode)	When error occurred	R
D8085	Slave 17 Communication Status/Error (When Data Link Master Mode)	When error occurred	R
D8086	Slave 18 Communication Status/Error (When Data Link Master Mode)	When error occurred	R
D8087	Slave 19 Communication Status/Error (When Data Link Master Mode)	When error occurred	R
D8088	Slave 20 Communication Status/Error (When Data Link Master Mode)	When error occurred	R
D8089	Slave 21 Communication Status/Error (When Data Link Master Mode)	When error occurred	R
D8090	Slave 22 Communication Status/Error (When Data Link Master Mode)	When error occurred	R
D8091	Slave 23 Communication Status/Error (When Data Link Master Mode)	When error occurred	R
D8092	Slave 24 Communication Status/Error (When Data Link Master Mode)	When error occurred	R
D8093	Slave 25 Communication Status/Error (When Data Link Master Mode)	When error occurred	R
D8094	Slave 26 Communication Status/Error (When Data Link Master Mode)	When error occurred	R
D8095	Slave 27 Communication Status/Error (When Data Link Master Mode)	When error occurred	R
D8096	Slave 28 Communication Status/Error (When Data Link Master Mode)	When error occurred	R
D8097	Slave 29 Communication Status/Error (When Data Link Master Mode)	When error occurred	R
D8098	Slave 30 Communication Status/Error (When Data Link Master Mode)	When error occurred	R
D8099	Slave 31 Communication Status/Error (When Data Link Master Mode)	When error occurred	R
D8100	Slave Number (Port 1)	—	R/W
D8101	— Reserved —	—	—
D8102	Slave Number (Port 2)	—	R/W
D8103	Slave Number (Port 3)	—	R/W
D8104	Control Signal Status (Port 1 to 5)	Every scan	R
D8105	RS232C DSR Input Control Signal Option (Port 1 to 5)	Every scan	R/W
D8106	RS232C DTR Output Control Signal Option (Port 1 to 5)	Every scan	R/W

Device Address	Description		Update Timing	R/W	
D8107 to D8119	— Reserved —		—	—	
D8120	HMI Module Information	Type ID/Status	—	R	
D8121		System Software Version	—	R	
D8122	Cartridge Slot 1 Information	Type ID/Status	—	R	
D8123		System Software Version	—	R	
D8124	Cartridge Slot 2 Information	Type ID/Status	—	R	
D8125		System Software Version	—	R	
D8126	Cartridge Slot 3 Information	Type ID/Status	—	R	
D8127		System Software Version	—	R	
D8128 to D8169	— Reserved —		—	—	
D8170	Analog I/O Cartridge I/O AI2/AQ2		Every scan	R	
D8171	Analog I/O Cartridge I/O AI3/AQ3		Every scan	R	
D8172	Analog I/O Cartridge Status AI2/AQ2		Every scan	R	
D8173	Analog I/O Cartridge Status AI3/AQ3		Every scan	R	
D8174	Analog I/O Cartridge I/O AI4/AQ4		Every scan	R	
D8175	Analog I/O Cartridge I/O AI5/AQ5		Every scan	R	
D8176	Analog I/O Cartridge Status AI4/AQ4		Every scan	R	
D8177	Analog I/O Cartridge Status AI5/AQ5		Every scan	R	
D8178	Analog I/O Cartridge I/O AI6/AQ6		Every scan	R	
D8179	Analog I/O Cartridge I/O AI7/AQ7		Every scan	R	
D8180	Analog I/O Cartridge Status AI6/AQ6		Every scan	R	
D8181	Analog I/O Cartridge Status AI7/AQ7		Every scan	R	
D8182 to D8191	— Reserved —		—	—	
D8192	High-speed Counter (Group 2/I1)	High Word	Current Value/Frequency Measurement (I1) Current Value	Every scan	R
D8193		Low Word		Every scan	R
D8194		High Word	Preset Value	—	R/W
D8195		Low Word		—	R/W
D8196		High Word	Reset Value	—	R/W
D8197		Low Word		—	R/W
D8198	High-speed Counter (Group 6/I7)	High Word	Current Value/Frequency Measurement (I7) Current Value	Every scan	R
D8199		Low Word		Every scan	R
D8200		High Word	Preset Value	—	R/W
D8201		Low Word		—	R/W
D8202		High Word	Reset Value	—	R/W
D8203		Low Word		—	R/W
D8204	Control Signal Status (Port 6 to 9)		Every scan	R	
D8205	RS232C DSR Input Control Signal Option (Port 6 to 9)		Every scan	R/W	
D8206	RS232C DTR Output Control Signal Option (Port 6 to 9)		Every scan	R/W	
D8207 to D8209	— Reserved —		—	—	
D8210	High-speed Counter (Group 1/I0)	High Word	Current Value/Frequency Measurement (I0) Current Value	Every scan	R
D8211		Low Word		Every scan	R
D8212		High Word	Preset Value	—	R/W
D8213		Low Word		—	R/W
D8214	Interrupt Input Jump Destination Label No. (I7)		—	R/W	
D8215	Interrupt Input Jump Destination Label No. (I0)		—	R/W	
D8216	High-speed Counter (Group 1/I0)	High Word	Reset Value	—	R/W
D8217		Low Word		—	R/W
D8218	High-speed Counter (Group 3/I3)	High Word	Current Value/Frequency Measurement (I3) Current Value	Every scan	R
D8219		Low Word		Every scan	R
D8220		High Word	Preset Value	—	R/W
D8221		Low Word		—	R/W

6: DEVICES

Device Address	Description			Update Timing	R/W
D8222	High-speed Counter (Group 4/I4)	High Word	Current Value/Frequency Measurement (I4) Current Value	Every scan	R
D8223		Low Word		Every scan	R
D8224		High Word	Preset Value	—	R/W
D8225		Low Word		—	R/W
D8226	High-speed Counter (Group 5/I6)	High Word	Current Value/Frequency Measurement (I6) Current Value	Every scan	R
D8227		Low Word		Every scan	R
D8228		High Word	Preset Value	—	R/W
D8229		Low Word		—	R/W
D8230 D8231	— Reserved —			—	—
D8232	High-speed Counter (Group 5/I6)	High Word	Reset Value	—	R/W
D8233		Low Word		—	R/W
D8234	High-speed Counter (Group 3/I3)	High Word	Reset Value	—	R/W
D8235		Low Word		—	R/W
D8236	High-speed Counter (Group 4/I4)	High Word	Reset Value	—	R/W
D8237		Low Word		—	R/W
D8238	— Reserved —			—	—
D8239	Absolute Position Control Status			Every scan	R
D8240	Absolute Position Counter 1	High Word	Absolute Position	Every scan	R
D8241		Low Word		Every scan	R
D8242	Absolute Position Counter 2	High Word	Absolute Position	Every scan	R
D8243		Low Word		Every scan	R
D8244	Absolute Position Counter 3	High Word	Absolute Position	Every scan	R
D8245		Low Word		Every scan	R
D8246	Absolute Position Counter 4	High Word	Absolute Position	Every scan	R
D8247		Low Word		Every scan	R
D8248 D8249	— Reserved —			—	—
D8250	Read SD Memory Card Capacity			Every scan	R
D8251	Read SD Memory Card Free Capacity			Every scan	R
D8252 D8253	— Reserved —			—	—
D8254	SD Memory Card Download/Upload Execution Information			When processing has completed	R
D8255	SD Memory Card Download/Upload Execution Status			When processing has completed	R
D8256	Download MQTT Basic Settings from SD Memory Card Execution Information			When processing has completed	R
D8257	Download MQTT Basic Settings from SD Memory Card Execution Error Information			When processing has completed	R
D8258 to D8259	— Reserved —			—	—
D8260	Recipe Block Number			—	R/W
D8261	Recipe Execution Block Number			When recipe execution has completed	R
D8262	Recipe Execution Channel No.			When recipe execution has completed	R
D8263	Recipe Execution Operation			When recipe execution has completed	R
D8264	Recipe Execution Status			When recipe execution has completed	R
D8265	Recipe Execution Error Information			When recipe execution has completed	R
D8266	Recipe Internal Memory (ROM-Range 1) Read Count			When recipe execution has completed	R

Device Address	Description	Update Timing	R/W
D8267	Recipe Internal Memory (ROM-Range 2) Read Count	When recipe execution has completed	R
D8268	Remote Host Number of Connection 1 (1 to 255)	—	R/W
D8269	Remote Host Number of Connection 2 (1 to 255)	—	R/W
D8270	Remote Host Number of Connection 3 (1 to 255)	—	R/W
D8271	Remote Host Number of Connection 4 (1 to 255)	—	R/W
D8272	Remote Host Number of Connection 5 (1 to 255)	—	R/W
D8273	Remote Host Number of Connection 6 (1 to 255)	—	R/W
D8274	Remote Host Number of Connection 7 (1 to 255)	—	R/W
D8275	Remote Host Number of Connection 8 (1 to 255)	—	R/W
D8276 D8277	— Reserved —	—	—
D8278	Communication Mode Information	Connection 1 to 4	R
D8279	(Client Connection)	Connection 5 to 8	R
D8280 to D8283	— Reserved —	—	—
D8284	Communication Mode Information	HMI Connection 1 to 4	R
D8285	(HMI Connection)	HMI Connection 5 to 8	R
D8286 to D8302	— Reserved —	—	—
D8303	CPU Module Ethernet Port 1 IP Settings/DNS Settings Switching	—	R/W
D8304	CPU Module Ethernet Port 1 IP Address (Write-only)	—	W
D8305		—	W
D8306		—	W
D8307		—	W
D8308		—	W
D8309	CPU Module Ethernet Port 1 Subnet Mask (Write-only)	—	W
D8310		—	W
D8311		—	W
D8312		—	W
D8313	CPU Module Ethernet Port 1 Default Gateway (Write-only)	—	W
D8314		—	W
D8315		—	W
D8316		—	W
D8317		—	W
D8318	CPU Module Ethernet Port 1 Preferred DNS Server (Write-only)	—	W
D8319		—	W
D8320		—	W
D8321	CPU Module Ethernet Port 1 Alternate DNS Server (Write-only)	—	W
D8322		—	W
D8323		—	W
D8324		—	W
D8325	CPU Module Ethernet Port 1 MAC Address (Current Value Read-only)	Every 1 s	R
D8326		Every 1 s	R
D8327		Every 1 s	R
D8328		Every 1 s	R
D8329		Every 1 s	R
D8330		Every 1 s	R
D8331	CPU Module Ethernet Port 1 IP Address (Current Value Read-only)	Every 1 s	R
D8332		Every 1 s	R
D8333		Every 1 s	R
D8334	CPU Module Ethernet Port 1 Subnet Mask (Current Value Read-only)	Every 1 s	R
D8335		Every 1 s	R
D8336		Every 1 s	R
D8337		Every 1 s	R

6: DEVICES

Device Address	Description	Update Timing	R/W
D8338	CPU Module Ethernet Port 1 Default Gateway (Current Value Read-only)	Every 1 s	R
D8339		Every 1 s	R
D8340		Every 1 s	R
D8341		Every 1 s	R
D8342	CPU Module Ethernet Port 1 Preferred DNS Server (Current Value Read-only)	Every 1 s	R
D8343		Every 1 s	R
D8344		Every 1 s	R
D8345		Every 1 s	R
D8346	CPU Module Ethernet Port 1 Alternate DNS Server (Current Value Read-only)	Every 1 s	R
D8347		Every 1 s	R
D8348		Every 1 s	R
D8349		Every 1 s	R
D8350	Connection 1 Connected IP Address	Every 1 s	R
D8351		Every 1 s	R
D8352		Every 1 s	R
D8353	Connection 2 Connected IP Address	Every 1 s	R
D8354		Every 1 s	R
D8355		Every 1 s	R
D8356		Every 1 s	R
D8357	Connection 3 Connected IP Address	Every 1 s	R
D8358		Every 1 s	R
D8359		Every 1 s	R
D8360		Every 1 s	R
D8361	Connection 4 Connected IP Address	Every 1 s	R
D8362		Every 1 s	R
D8363		Every 1 s	R
D8364		Every 1 s	R
D8365	Connection 5 Connected IP Address	Every 1 s	R
D8366		Every 1 s	R
D8367		Every 1 s	R
D8368		Every 1 s	R
D8369	Connection 6 Connected IP Address	Every 1 s	R
D8370		Every 1 s	R
D8371		Every 1 s	R
D8372		Every 1 s	R
D8373	Connection 7 Connected IP Address	Every 1 s	R
D8374		Every 1 s	R
D8375		Every 1 s	R
D8376		Every 1 s	R
D8377	Connection 8 Connected IP Address	Every 1 s	R
D8378		Every 1 s	R
D8379		Every 1 s	R
D8380		Every 1 s	R
D8381	HMI Module MAC Address (Current Value Read-only)	Every 1 s	R
D8382		Every 1 s	R
D8383		Every 1 s	R
D8384		Every 1 s	R
D8385		Every 1 s	R
D8386		Every 1 s	R
D8387	HMI Module IP Address (Current Value Read-only)	Every 1 s	R
D8388		Every 1 s	R
D8389		Every 1 s	R
D8390		Every 1 s	R
D8391		Every 1 s	R

Device Address	Description	Update Timing	R/W	
D8392	HMI Module Subnet Mask (Current Value Read-only)	Every 1 s	R	
D8393		Every 1 s	R	
D8394		Every 1 s	R	
D8395		Every 1 s	R	
D8396	HMI Module Default Gateway (Current Value Read-only)	Every 1 s	R	
D8397		Every 1 s	R	
D8398		Every 1 s	R	
D8399		Every 1 s	R	
D8400	HMI Module Preferred DNS Server (Current Value Read-only)	Every 1 s	R	
D8401		Every 1 s	R	
D8402		Every 1 s	R	
D8403		Every 1 s	R	
D8404	HMI Module Alternate DNS Server (Current Value Read-only)	Every 1 s	R	
D8405		Every 1 s	R	
D8406		Every 1 s	R	
D8407		Every 1 s	R	
D8408 to D8412	— Reserved —	—	—	
D8413	Time Zone Offset	—	R/W	
D8414	SNTP Operation Status	—	R	
D8415	SNTP Access Elapsed Time	—	R	
D8416 to D8428	— Reserved —	—	—	
D8429	HMI Module Connection Information Reference	Connection No.	R/W	
D8430		Connected IP Address	Every 1 s	R
D8431			Every 1 s	R
D8432			Every 1 s	R
D8433		Connected Port No.	Every 1 s	R
D8434	Every 1 s		R	
D8435 D8436	— Reserved —	—	—	
D8437	HMI Module IP Address (Write-only)	—	W	
D8438		—	W	
D8439		—	W	
D8440		—	W	
D8441	HMI Module Subnet Mask (Write-only)	—	W	
D8442		—	W	
D8443		—	W	
D8444		—	W	
D8445	HMI Module Default Gateway (Write-only)	—	W	
D8446		—	W	
D8447		—	W	
D8448		—	W	
D8449	HMI Module Preferred DNS Server (Write-only)	—	W	
D8450		—	W	
D8451		—	W	
D8452		—	W	
D8453	HMI Module Alternate DNS Server (Write-only)	—	W	
D8454		—	W	
D8455		—	W	
D8456		—	W	
D8457	EMAIL Instruction Detailed Error Information (HMI-Ethernet Port)	—	R	
D8458 to D8469	— Reserved —	—	—	

6: DEVICES

Device Address	Description	Update Timing	R/W	
D8470	Expansion Module Slot 1	Type ID/Status	—	R
D8471	Information	System Software Version/Position Information	—	R
D8472	Expansion Module Slot 2	Type ID/Status	—	R
D8473	Information	System Software Version/Position Information	—	R
D8474	Expansion Module Slot 3	Type ID/Status	—	R
D8475	Information	System Software Version/Position Information	—	R
D8476	Expansion Module Slot 4	Type ID/Status	—	R
D8477	Information	System Software Version/Position Information	—	R
D8478	Expansion Module Slot 5	Type ID/Status	—	R
D8479	Information	System Software Version/Position Information	—	R
D8480	Expansion Module Slot 6	Type ID/Status	—	R
D8481	Information	System Software Version/Position Information	—	R
D8482	Expansion Module Slot 7	Type ID/Status	—	R
D8483	Information	System Software Version/Position Information	—	R
D8484	Expansion Module Slot 8	Type ID/Status	—	R
D8485	Information	System Software Version/Position Information	—	R
D8486	Expansion Module Slot 9	Type ID/Status	—	R
D8487	Information	System Software Version/Position Information	—	R
D8488	Expansion Module Slot 10	Type ID/Status	—	R
D8489	Information	System Software Version/Position Information	—	R
D8490	Expansion Module Slot 11	Type ID/Status	—	R
D8491	Information	System Software Version/Position Information	—	R
D8492	Expansion Module Slot 12	Type ID/Status	—	R
D8493	Information	System Software Version/Position Information	—	R
D8494	Expansion Module Slot 13	Type ID/Status	—	R
D8495	Information	System Software Version/Position Information	—	R
D8496	Expansion Module Slot 14	Type ID/Status	—	R
D8497	Information	System Software Version/Position Information	—	R
D8498	Expansion Module Slot 15	Type ID/Status	—	R
D8499	Information	System Software Version/Position Information	—	R
D8500	Expansion Module Slot 16	Type ID/Status	—	R
D8501	Information	System Software Version/Position Information	—	R
D8502	Expansion Module Slot 17	Type ID/Status	—	R
D8503	Information	System Software Version/Position Information	—	R
D8504	Expansion Module Slot 18	Type ID/Status	—	R
D8505	Information	System Software Version/Position Information	—	R
D8506	Expansion Module Slot 19	Type ID/Status	—	R
D8507	Information	System Software Version/Position Information	—	R
D8508	Expansion Module Slot 20	Type ID/Status	—	R
D8509	Information	System Software Version/Position Information	—	R
D8510	Expansion Module Slot 21	Type ID/Status	—	R
D8511	Information	System Software Version/Position Information	—	R
D8512	Expansion Module Slot 22	Type ID/Status	—	R
D8513	Information	System Software Version/Position Information	—	R
D8514	Expansion Module Slot 23	Type ID/Status	—	R
D8515	Information	System Software Version/Position Information	—	R
D8516	Expansion Module Slot 24	Type ID/Status	—	R
D8517	Information	System Software Version/Position Information	—	R
D8518	Expansion Module Slot 25	Type ID/Status	—	R
D8519	Information	System Software Version/Position Information	—	R
D8520	Expansion Module Slot 26	Type ID/Status	—	R
D8521	Information	System Software Version/Position Information	—	R
D8522	Expansion Module Slot 27	Type ID/Status	—	R
D8523	Information	System Software Version/Position Information	—	R

Device Address	Description	Update Timing	R/W
D8524	Expansion Module Slot 28 Information	Type ID/Status	R
D8525		System Software Version/Position Information	R
D8526	Expansion Module Slot 29 Information	Type ID/Status	R
D8527		System Software Version/Position Information	R
D8528	Expansion Module Slot 30 Information	Type ID/Status	R
D8529		System Software Version/Position Information	R
D8530	Expansion Module Slot 31 Information	Type ID/Status	R
D8531		System Software Version/Position Information	R
D8532	Expansion Module Slot 32 Information	Type ID/Status	R
D8533		System Software Version/Position Information	R
D8534	Expansion Module Slot 33 Information	Type ID/Status	R
D8535		System Software Version/Position Information	R
D8536	Expansion Module Slot 34 Information	Type ID/Status	R
D8537		System Software Version/Position Information	R
D8538	Expansion Module Slot 35 Information	Type ID/Status	R
D8539		System Software Version/Position Information	R
D8530	Expansion Module Slot 36 Information	Type ID/Status	R
D8541		System Software Version/Position Information	R
D8542	Expansion Module Slot 37 Information	Type ID/Status	R
D8543		System Software Version/Position Information	R
D8544	Expansion Module Slot 38 Information	Type ID/Status	R
D8545		System Software Version/Position Information	R
D8546	Expansion Module Slot 39 Information	Type ID/Status	R
D8547		System Software Version/Position Information	R
D8548	Expansion Module Slot 40 Information	Type ID/Status	R
D8549		System Software Version/Position Information	R
D8550	Expansion Module Slot 41 Information	Type ID/Status	R
D8551		System Software Version/Position Information	R
D8552	Expansion Module Slot 42 Information	Type ID/Status	R
D8553		System Software Version/Position Information	R
D8554	Expansion Module Slot 43 Information	Type ID/Status	R
D8555		System Software Version/Position Information	R
D8556	Expansion Module Slot 44 Information	Type ID/Status	R
D8557		System Software Version/Position Information	R
D8558	Expansion Module Slot 45 Information	Type ID/Status	R
D8559		System Software Version/Position Information	R
D8560	Expansion Module Slot 46 Information	Type ID/Status	R
D8561		System Software Version/Position Information	R
D8562	Expansion Module Slot 47 Information	Type ID/Status	R
D8563		System Software Version/Position Information	R
D8564	Expansion Module Slot 48 Information	Type ID/Status	R
D8565		System Software Version/Position Information	R
D8566	Expansion Module Slot 49 Information	Type ID/Status	R
D8567		System Software Version/Position Information	R
D8568	Expansion Module Slot 50 Information	Type ID/Status	R
D8569		System Software Version/Position Information	R
D8570	Expansion Module Slot 51 Information	Type ID/Status	R
D8571		System Software Version/Position Information	R
D8572	Expansion Module Slot 52 Information	Type ID/Status	R
D8573		System Software Version/Position Information	R
D8574	Expansion Module Slot 53 Information	Type ID/Status	R
D8575		System Software Version/Position Information	R
D8576	Expansion Module Slot 54 Information	Type ID/Status	R
D8577		System Software Version/Position Information	R

6: DEVICES

Device Address	Description	Update Timing	R/W	
D8578	Expansion Module Slot 55	Type ID/Status	—	R
D8579	Information	System Software Version/Position Information	—	R
D8580	Expansion Module Slot 56	Type ID/Status	—	R
D8581	Information	System Software Version/Position Information	—	R
D8582	Expansion Module Slot 57	Type ID/Status	—	R
D8583	Information	System Software Version/Position Information	—	R
D8584	Expansion Module Slot 58	Type ID/Status	—	R
D8585	Information	System Software Version/Position Information	—	R
D8586	Expansion Module Slot 59	Type ID/Status	—	R
D8587	Information	System Software Version/Position Information	—	R
D8588	Expansion Module Slot 60	Type ID/Status	—	R
D8589	Information	System Software Version/Position Information	—	R
D8590	Expansion Module Slot 61	Type ID/Status	—	R
D8591	Information	System Software Version/Position Information	—	R
D8592	Expansion Module Slot 62	Type ID/Status	—	R
D8593	Information	System Software Version/Position Information	—	R
D8594	Expansion Module Slot 63	Type ID/Status	—	R
D8595	Information	System Software Version/Position Information	—	R
D8596		Type ID/Status	—	R
D8597	Expansion Interface Remote Master Module Slot Information	System Software Version/ Number of Connected Expansion Interface Remote Slave Modules	—	R
D8598	Expansion Interface Remote Slave Module (Node 1) Slot Information	Type ID/Status	—	R
D8599		System Software Version/ Expansion Module Connection Information	—	R
D8600	Expansion Interface Remote Slave Module (Node 2) Slot Information	Type ID/Status	—	R
D8601		System Software Version/ Expansion Module Connection Information	—	R
D8602	Expansion Interface Remote Slave Module (Node 3) Slot Information	Type ID/Status	—	R
D8603		System Software Version/ Expansion Module Connection Information	—	R
D8604	Expansion Interface Remote Slave Module (Node 4) Slot Information	Type ID/Status	—	R
D8605		System Software Version/ Expansion Module Connection Information	—	R
D8606	Expansion Interface Remote Slave Module (Node 5) Slot Information	Type ID/Status	—	R
D8607		System Software Version/ Expansion Module Connection Information	—	R
D8608	Expansion Interface Remote Slave Module (Node 6) Slot Information	Type ID/Status	—	R
D8609		System Software Version/ Expansion Module Connection Information	—	R
D8610	Expansion Interface Remote Slave Module (Node 7) Slot Information	Type ID/Status	—	R
D8611		System Software Version/ Expansion Module Connection Information	—	R
D8612	Expansion Interface Remote Slave Module (Node 8) Slot Information	Type ID/Status	—	R
D8613		System Software Version/ Expansion Module Connection Information	—	R
D8614	Expansion Interface Remote Slave Module (Node 9) Slot Information	Type ID/Status	—	R
D8615		System Software Version/ Expansion Module Connection Information	—	R
D8616	Expansion Interface Remote Slave Module (Node 10) Slot Information	Type ID/Status	—	R
D8617		System Software Version/ Expansion Module Connection Information	—	R
D8618	Refresh Time of Expansion Interface Remote Master/Slave Modules Current Value	Every scan		R
D8619	Refresh Time of Expansion Interface Remote Master/Slave Modules Maximum Value	Every scan		R
D8620 to D8629	— Reserved —	—		—
D8630	CPU Module Ethernet Port 2 IP Settings/DNS Settings Switching	—		R/W

Device Address	Description	Update Timing	R/W
D8631	CPU Module Ethernet Port 2 IP Address (Write-only)	—	W
D8632		—	W
D8633		—	W
D8634		—	W
D8635	CPU Module Ethernet Port 2 Subnet Mask (Write-only)	—	W
D8636		—	W
D8637		—	W
D8638		—	W
D8639	CPU Module Ethernet Port 2 Default Gateway (Write-only)	—	W
D8640		—	W
D8641		—	W
D8642		—	W
D8643	CPU Module Ethernet Port 2 Preferred DNS Server (Write-only)	—	W
D8644		—	W
D8645		—	W
D8646		—	W
D8647	CPU Module Ethernet Port 2 Alternate DNS Server (Write-only)	—	W
D8648		—	W
D8649		—	W
D8650		—	W
D8651	CPU Module Ethernet Port 2 MAC Address (Current Value Read-only)	Every 1 s	R
D8652		Every 1 s	R
D8653		Every 1 s	R
D8654		Every 1 s	R
D8655		Every 1 s	R
D8656		Every 1 s	R
D8657	CPU Module Ethernet Port 2 IP Address (Current Value Read-only)	Every 1 s	R
D8658		Every 1 s	R
D8659		Every 1 s	R
D8660		Every 1 s	R
D8661	CPU Module Ethernet Port 2 Subnet Mask (Current Value Read-only)	Every 1 s	R
D8662		Every 1 s	R
D8663		Every 1 s	R
D8664		Every 1 s	R
D8665	CPU Module Ethernet Port 2 Default Gateway (Current Value Read-only)	Every 1 s	R
D8666		Every 1 s	R
D8667		Every 1 s	R
D8668		Every 1 s	R
D8669	CPU Module Ethernet Port 2 Preferred DNS Server (Current Value Read-only)	Every 1 s	R
D8670		Every 1 s	R
D8671		Every 1 s	R
D8672		Every 1 s	R
D8673	CPU Module Ethernet Port 2 Alternate DNS Server (Current Value Read-only)	Every 1 s	R
D8674		Every 1 s	R
D8675		Every 1 s	R
D8676		Every 1 s	R
D8677	Connection 9 Connected IP Address	Every 1 s	R
D8678		Every 1 s	R
D8679		Every 1 s	R
D8680		Every 1 s	R
D8681	Connection 10 Connected IP Address	Every 1 s	R
D8682		Every 1 s	R
D8683		Every 1 s	R
D8684		Every 1 s	R

6: DEVICES

Device Address	Description	Update Timing	R/W
D8685	Connection 11 Connected IP Address	Every 1 s	R
D8686		Every 1 s	R
D8687		Every 1 s	R
D8688		Every 1 s	R
D8689	Connection 12 Connected IP Address	Every 1 s	R
D8690		Every 1 s	R
D8691		Every 1 s	R
D8692		Every 1 s	R
D8693	Connection 13 Connected IP Address	Every 1 s	R
D8694		Every 1 s	R
D8695		Every 1 s	R
D8696		Every 1 s	R
D8697	Connection 14 Connected IP Address	Every 1 s	R
D8698		Every 1 s	R
D8699		Every 1 s	R
D8700		Every 1 s	R
D8701	Connection 15 Connected IP Address	Every 1 s	R
D8702		Every 1 s	R
D8703		Every 1 s	R
D8704		Every 1 s	R
D8705	Connection 16 Connected IP Address	Every 1 s	R
D8706		Every 1 s	R
D8707		Every 1 s	R
D8708		Every 1 s	R
D8709 to D8716	— Reserved —	—	—
D8717	Control Signal Status (Port 10 to 13)	Every scan	R
D8718	RS232C DSR Input Control Signal Option (Port 10 to 13)	Every scan	R/W
D8719	RS232C DTR Output Control Signal Option (Port 10 to 13)	Every scan	R/W
D8720	Control Signal Status (Port 14 to 17)	Every scan	R
D8721	RS232C DSR Input Control Signal Option (Port 14 to 17)	Every scan	R/W
D8722	RS232C DTR Output Control Signal Option (Port 14 to 17)	Every scan	R/W
D8723	Control Signal Status (Port 18 to 21)	Every scan	R
D8724	RS232C DSR Input Control Signal Option (Port 18 to 21)	Every scan	R/W
D8725	RS232C DTR Output Control Signal Option (Port 18 to 21)	Every scan	R/W
D8726	Control Signal Status (Port 22 to 25)	Every scan	R
D8727	RS232C DSR Input Control Signal Option (Port 22 to 25)	Every scan	R/W
D8728	RS232C DTR Output Control Signal Option (Port 22 to 25)	Every scan	R/W
D8729	Control Signal Status (Port 26 to 29)	Every scan	R
D8730	RS232C DSR Input Control Signal Option (Port 26 to 29)	Every scan	R/W
D8731	RS232C DTR Output Control Signal Option (Port 26 to 29)	Every scan	R/W
D8732	Control Signal Status (Port 30 to 33)	Every scan	R
D8733	RS232C DSR Input Control Signal Option (Port 30 to 33)	Every scan	R/W
D8734	RS232C DTR Output Control Signal Option (Port 30 to 33)	Every scan	R/W
D8735	Slave Number (Port 10)	—	R/W
D8736	Slave Number (Port 11)	—	R/W
D8737	Slave Number (Port 12)	—	R/W
D8738	Slave Number (Port 13)	—	R/W
D8739	Slave Number (Port 14)	—	R/W
D8740	Slave Number (Port 15)	—	R/W
D8741	Slave Number (Port 16)	—	R/W
D8742	Slave Number (Port 17)	—	R/W
D8743	Slave Number (Port 18)	—	R/W
D8744	Slave Number (Port 19)	—	R/W
D8745	Slave Number (Port 20)	—	R/W

Device Address	Description	Update Timing	R/W
D8746	Slave Number (Port 21)	—	R/W
D8747	Slave Number (Port 22)	—	R/W
D8748	Slave Number (Port 23)	—	R/W
D8749	Slave Number (Port 24)	—	R/W
D8750	Slave Number (Port 25)	—	R/W
D8751	Slave Number (Port 26)	—	R/W
D8752	Slave Number (Port 27)	—	R/W
D8753	Slave Number (Port 28)	—	R/W
D8754	Slave Number (Port 29)	—	R/W
D8755	Slave Number (Port 30)	—	R/W
D8756	Slave Number (Port 31)	—	R/W
D8757	Slave Number (Port 32)	—	R/W
D8758	Slave Number (Port 33)	—	R/W
D8759	EMAIL Instruction Detailed Error Information (Ethernet Port 1)	—	R
D8760	Communication Mode Information (Client Connection)	Connection 9 to 12	R
D8761		Connection 13 to 16	R
D8762 to D8773	— Reserved —	—	—
D8774	Remote Host Number of Connection 9 (1 to 255)	—	R/W
D8775	Remote Host Number of Connection 10 (1 to 255)	—	R/W
D8776	Remote Host Number of Connection 11 (1 to 255)	—	R/W
D8777	Remote Host Number of Connection 12 (1 to 255)	—	R/W
D8778	Remote Host Number of Connection 13 (1 to 255)	—	R/W
D8779	Remote Host Number of Connection 14 (1 to 255)	—	R/W
D8780	Remote Host Number of Connection 15 (1 to 255)	—	R/W
D8781	Remote Host Number of Connection 16 (1 to 255)	—	R/W
D8782	BACnet Operation Status	—	R
D8783	BACnet Error Information	—	R
D8784 to D8789	— Reserved —	—	—
D8790	EtherNet/IP Operation Status	—	R
D8791	EtherNet/IP Error Information	—	R
D8792 to D8899	— Reserved —	—	—

Supplementary Descriptions of the Special Data Registers

■ D8000: Quantity of Inputs

The number of FC6A Series MICROSmart inputs is written to this register.

The total number of inputs for the CPU module and the expansion modules is written to this register.

■ D8001: Quantity of Outputs

The number of FC6A Series MICROSmart outputs is written to this register.

The total number of outputs for the CPU module and the expansion modules is written to this register.

■ D8002: CPU Module Type Information

CPU module type information is written this register.

0 (00h): 16-I/O type

1 (01h): 24-I/O type

2 (02h): 40-I/O type (All-in-One CPU module)

18 (12h): 40-I/O type (CAN J1939 All-in-One CPU module)

32 (20h): Plus 16-I/O type

33 (21h): Plus 32-I/O type

■ D8005: General Error Code

FC6A Series MICROSmart general error information is written to this register. When a general error occurs, the bit corresponding to the error occurred turns on. The general error and user program execution error can be cleared by writing "1" to the most significant bit of D8005. For details on general error codes, see "General Error Codes" on page 13-3.

■ **D8006: User Program Execution Error Code**

FC6A Series MICROSmartuser program execution error information is written to this register. When a user program execution error occurs, the error code corresponding to the error that occurred is written to this register. For details on user program execution errors, see "User Program Execution Error" on page 13-6.

■ **D8008 to D8021: Calendar/Clock Data**

D8008 through D8021 are used for reading calendar/clock data from the internal clock and for writing calendar/clock data to the internal clock. For details on the calendar/clock data, see "Clock Function" on page 5-63.

■ **D8022 to D8025: Scan Time Data**

D8022 through D8025 are special data registers for checking the scan time and configuring the constant scan time. For details on the scan time, see "Constant Scan Time" on page 5-61.

■ **D8026: Communication Mode Information (Port 1 to 3)**

This register indicates communication mode information for Port 1 to Port 3. The allocation of communication ports in the device (bit assignment) is as follows.

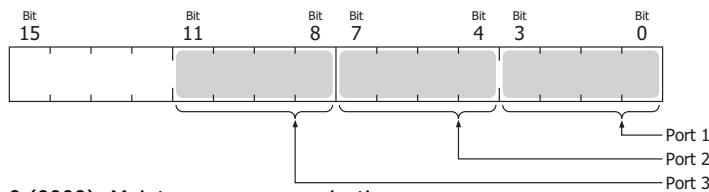

- 0 (0000): Maintenance communication
- 1 (0001): User communication
- 2 (0010): Modbus RTU master
- 3 (0011): Modbus RTU slave
- 4 (0100): Data link communication

■ **D8029: System Software Version**

The CPU module system software version number is written to this register.

■ **D8030: Communication Cartridge Information**

This register indicates information about the communication cartridges in Port 2 and Port 3. The allocation of communication ports in the device (bit assignment) is as follows.

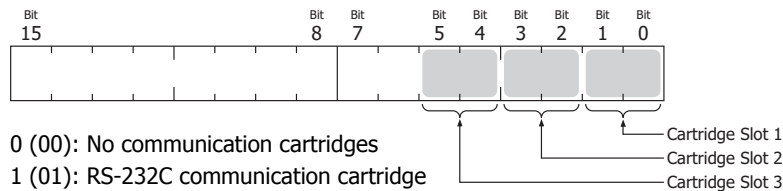

- 0 (00): No communication cartridges
- 1 (01): RS-232C communication cartridge
- 2 (10): RS-485 communication cartridge
- 3 (11): Bluetooth communication cartridge

■ **D8031: Optional Device Connection Information**

Optional device connection information is written to this register. The allocation of bits in the device (bit assignment) is as follows.

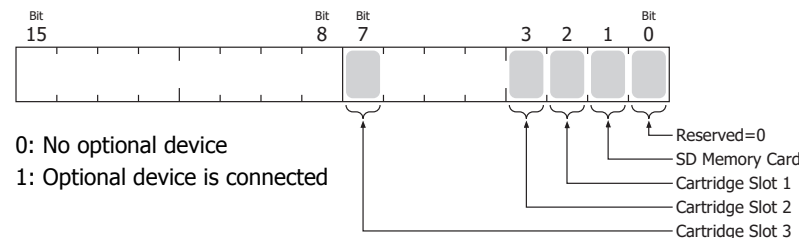

- 0: No optional device
- 1: Optional device is connected

■ **D8032 to D8035, D8214, D8215: Interrupt Input Jump Destination Label No.**

Jump destination label numbers for interrupt inputs are written to these registers. When using interrupt inputs, write the label number that corresponds to the special data register that has been allocated to the interrupt input. For details on interrupt inputs, see "Interrupt Input" on page 5-37.

- D8032 = I1
- D8033 = I3

D8034 = I4
 D8035 = I6
 D8214 = I7
 D8215 = I0

■ **D8036: Timer Interrupt Jump Destination Label No.**

The jump destination label number when the timer interrupt occurs is written to this register. When using the timer interrupt, store the corresponding label number.

For details on the timer interrupt, see "Timer Interrupt" on page 5-48.

■ **D8037: Number of Connected Expansion Modules**

The number of expansion modules connected to the CPU module (I/O modules, PID modules, and communication modules) is written to this register.

■ **D8052: J1939 Communication Error Code**

When an error occurs in J1939 communication, the error code is written to this register. For details on J1939 communication error codes, see Chapter 8 "J1939 Communication Error Code (D8052)" in the "FC6A Series MICROSmart Communication Manual".

■ **D8056: Battery Voltage**

The measurement result of the backup battery voltage is written to this register in 1 mV units.

0: Measurement error

■ **D8057: Analog Volume (AI0)**

The analog volume value is converted to a digital value and written to this register. For details, see "Analog Potentiometer" on page 5-46.

■ **D8058: Built-in Analog Input (AI1)**

The analog input's analog value (0 to 10V DC) is converted to a digital value and written to this register. For details, see "Analog Voltage Input" on page 5-44.

■ **D8059: Analog Input Status AI0**

The analog volume's analog input status is written to this register. For details, see "Analog Potentiometer" on page 5-46.

■ **D8060: Analog Input Status AI1**

The analog input's analog input status is written to this register. For details, see "Analog Voltage Input" on page 5-44.

■ **D8067: Backlight ON Time**

The backlight on time for the HMI module is written to this register. The backlight on time can be set by modifying the value of D8067 in a range between 1 and 65,535 s. When D8067 is 0 s, the backlight is always on. The backlight on time can also be changed with the HMI environment settings. For details, see "Setting the LCD Backlight ON Time" on page 7-13.

■ **D8069 to D8099: Slave (1 to 31) Communication Status/Error**

Special data registers used in data link communication. For details, see Chapter 7 "Master Station" in the "FC6A Series MICROSmart Communication Manual".

■ **D8040 to D8045, D8100, D8102, D8103, D8735 to D8758: Slave Number (Port 1 to 33)**

The slave number is written to these registers when the Port 1 to 33 communication mode is maintenance communication, Modbus RTU slave, or data link communication. The slave number can be changed by changing the value of the corresponding device in **Function Area Settings**.

6: DEVICES

D8100 = Port 1 Slave No.
D8102 = Port 2 Slave No.
D8103 = Port 3 Slave No.

D8040 = Port 4 Slave No.
D8041 = Port 5 Slave No.
D8042 = Port 6 Slave No.
D8043 = Port 7 Slave No.
D8044 = Port 8 Slave No.
D8045 = Port 9 Slave No.
D8735 = Port 10 Slave No.
D8736 = Port 11 Slave No.
D8737 = Port 12 Slave No.
D8738 = Port 13 Slave No.
D8739 = Port 14 Slave No.
D8740 = Port 15 Slave No.
D8741 = Port 16 Slave No.

D8742 = Port 17 Slave No.
D8743 = Port 18 Slave No.
D8744 = Port 19 Slave No.
D8745 = Port 20 Slave No.
D8746 = Port 21 Slave No.
D8747 = Port 22 Slave No.
D8748 = Port 23 Slave No.
D8749 = Port 24 Slave No.
D8750 = Port 25 Slave No.
D8751 = Port 26 Slave No.
D8752 = Port 27 Slave No.
D8753 = Port 28 Slave No.
D8754 = Port 29 Slave No.
D8755 = Port 30 Slave No.
D8756 = Port 31 Slave No.
D8757 = Port 32 Slave No.
D8758 = Port 33 Slave No.

For details on communication modes, see the following in the "FC6A Series MICROSmart Communication Manual".

- Maintenance communication: Chapter 4 "Maintenance Communication"
- Modbus RTU slave: Chapter 6 "Modbus Communication"
- Data link communication: Chapter 7 "Data Link Communication"

■ **D8104, D8204, D8717, D8720, D8723, D8726, D8729, D8732: Control Signal Status (Port 1 to 33)**

The signal statuses of the DSR and DTR controls lines are written to this register. This register is updated in END processing when stopped and while running. The allocation of communication ports in the device (bit assignment) is as follows.

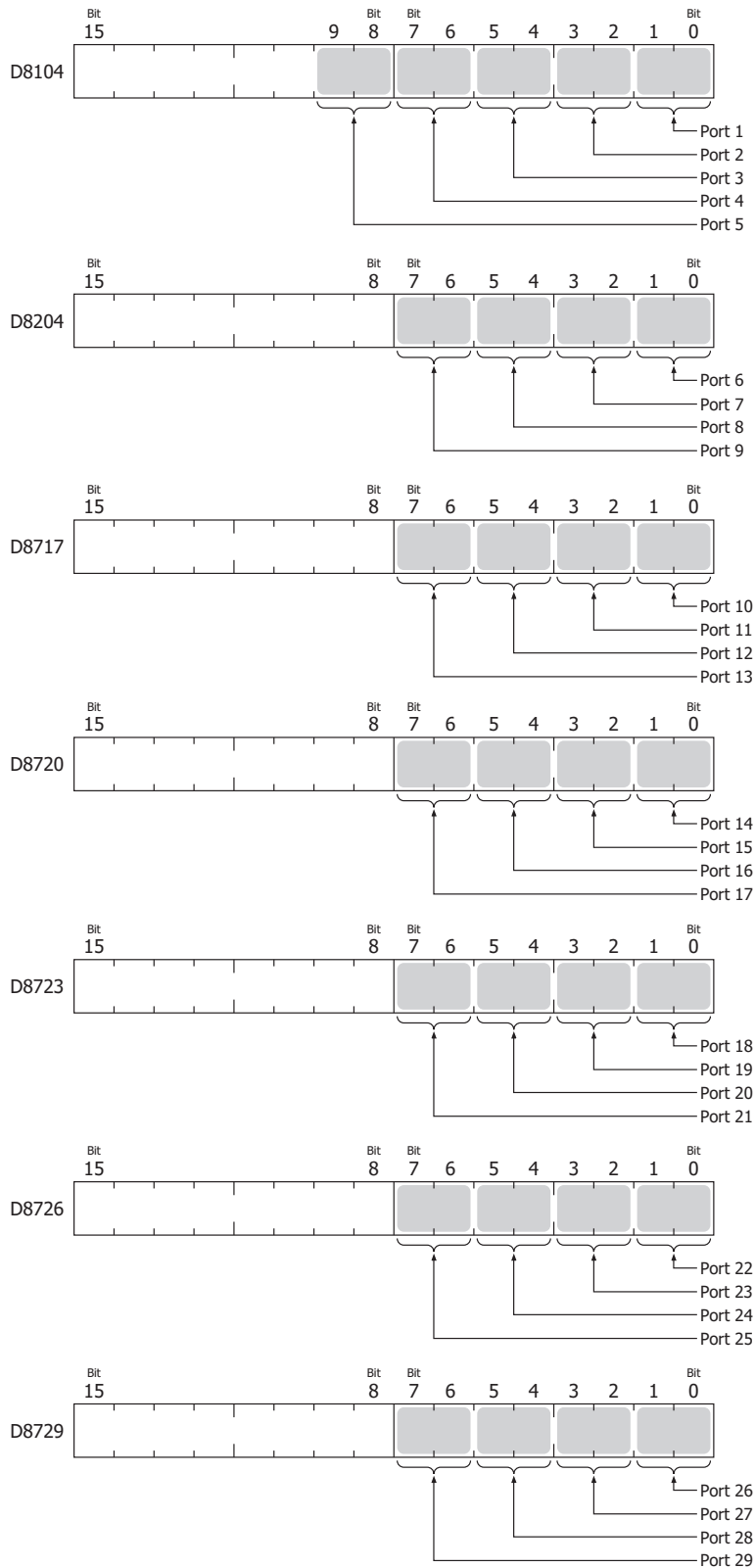

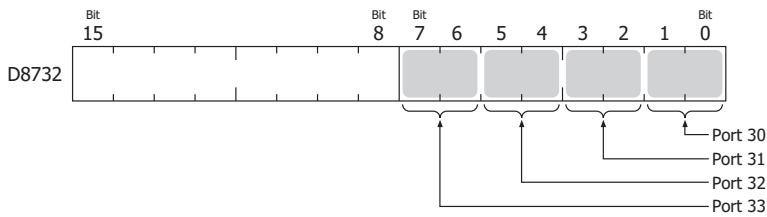

- 0 (00): DTR and DSR are both off.
- 1 (01): DTR is off and DSR is on.
- 2 (10): DTR is on and DSR is off.
- 3 (11): DTR and DSR are both on.

■ **D8105, D8205, D8718, D8721, D8724, D8727, D8730, D8733: RS232C DSR Input Control Signal Option (Port 1 to 33)**

The signal statuses of the DSR and DTR controls lines are written to this register. This register is updated in END processing when stopped and while running. The allocation of communication ports in the device (bit assignment) is as follows.

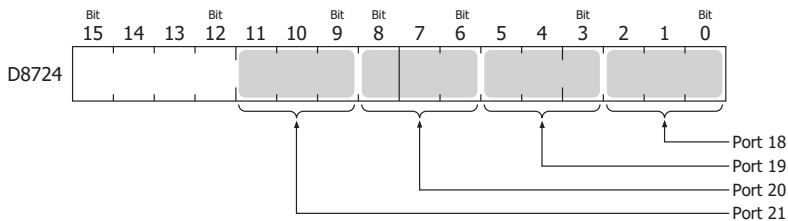
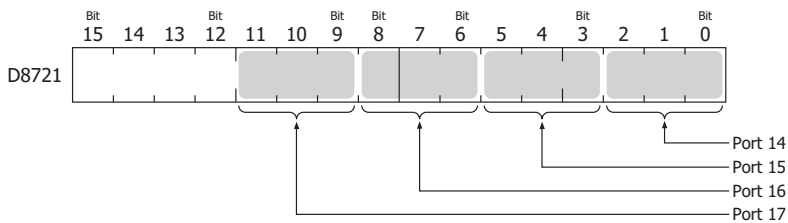
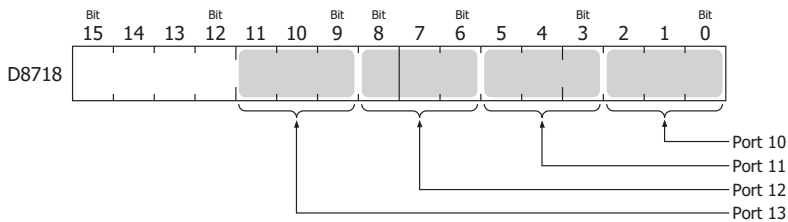
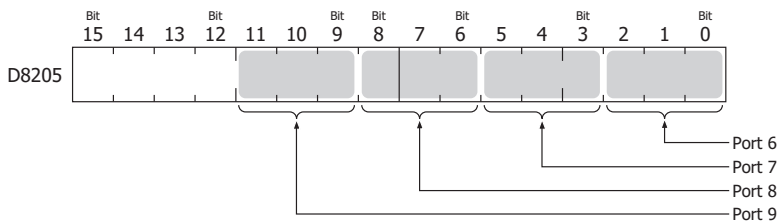
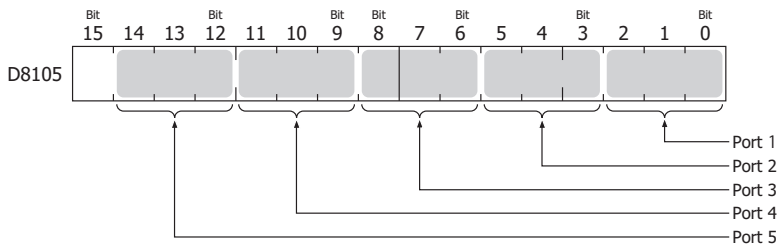

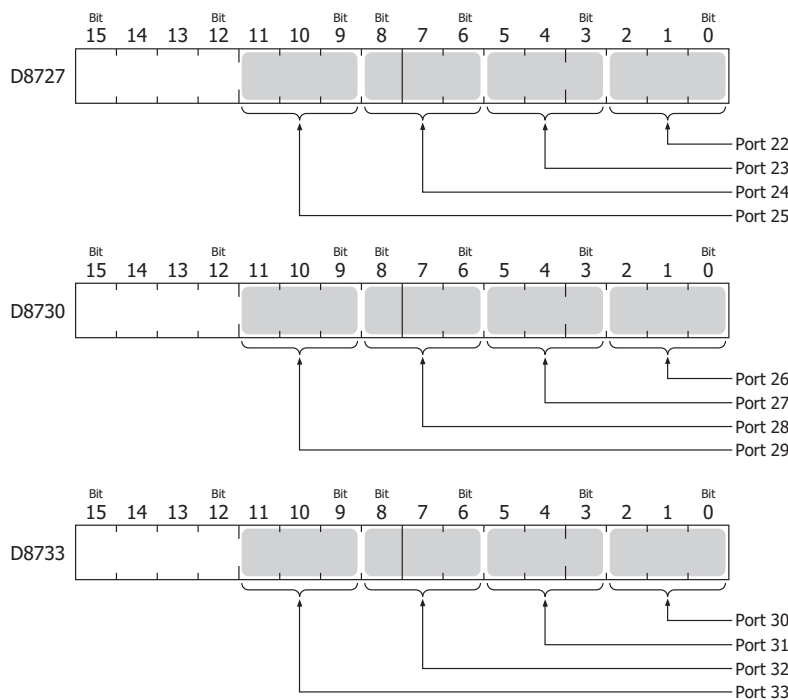

0 (000): The DSR signal status is not used for FC6A Series MICROSmart transmission control. Use this status when DSR signal control is not required.

1 (001): When the DSR signal is on, the FC6A Series MICROSmart can transmit and receive.

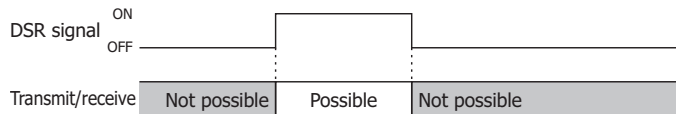

2 (010): When the DSR signal is off, the FC6A Series MICROSmart can transmit and receive.

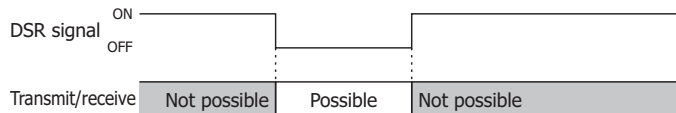

3 (011): When the DSR signal is on, transmission is possible (reception is always possible).

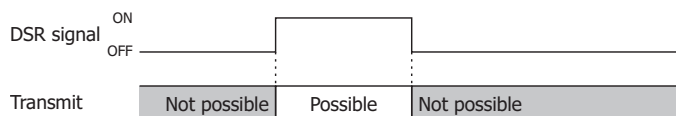

This is normally called "busy control" and is used for transmission control for devices with a slow processing speed such as printers.

(As viewed from the connected device, there is a limit on the data that can be input.)

4 (100): When the DSR signal is off, transmission is possible.

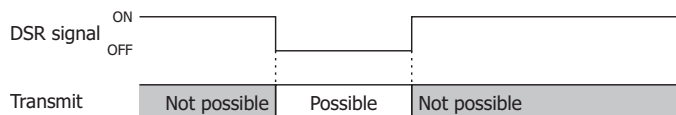

5 or higher: The operation is the same as the setting "000".

■ **D8106, D8206, D8719, D8722, D8725, D8728, D8731, D8734: RS232C DTR Output Control Signal Option (Port 1 to 33)**

This register is used when indicating the FC6A Series MICROSmart control status and the transmit/receive status to the connected device. This control line is an output signal from the FC6A Series MICROSmart to the connected device. This register is only valid during user communication.

The allocation of communication ports in the device (bit assignment) is as follows.

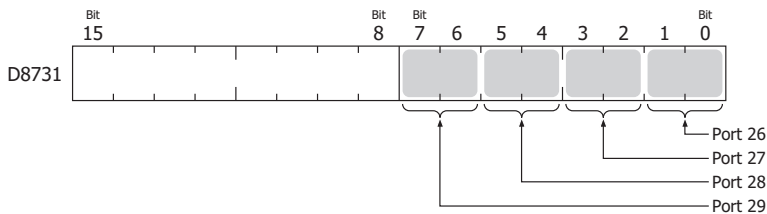
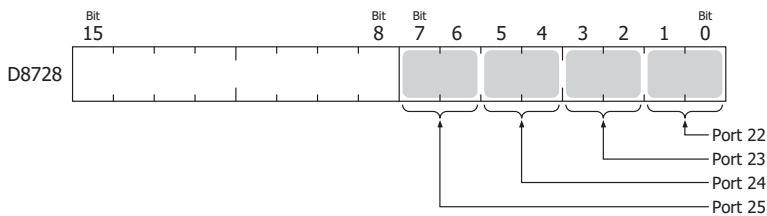
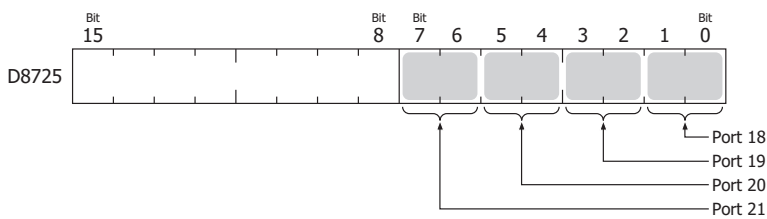
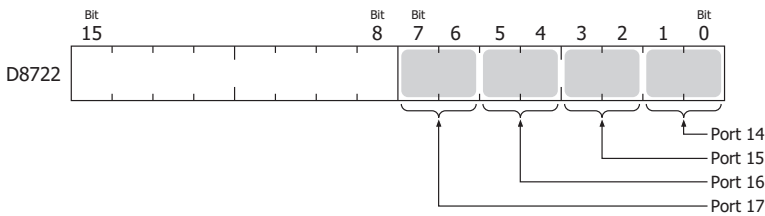
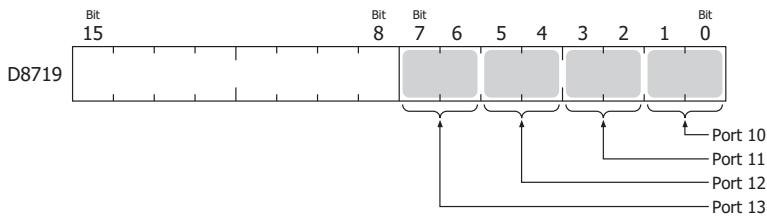
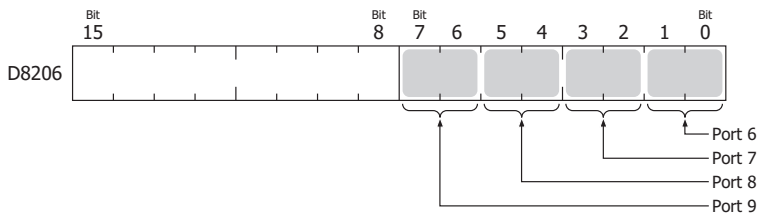
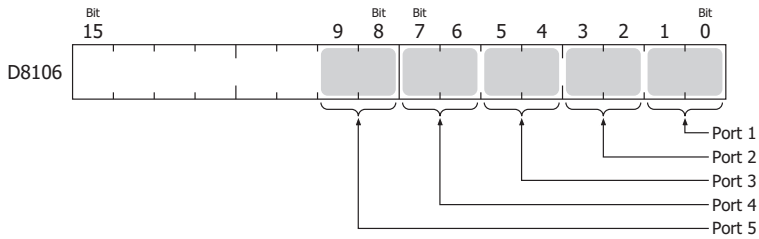

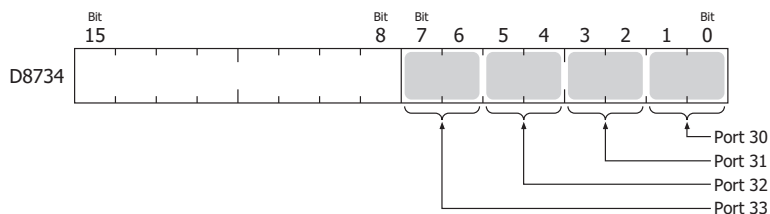

0 (00): The signal is on when the FC6A Series MICROSmart is set to run and off when stopped. While running, the signal is always on regardless of transmitting or receiving data. Set this value when it is necessary to indicate the run status.

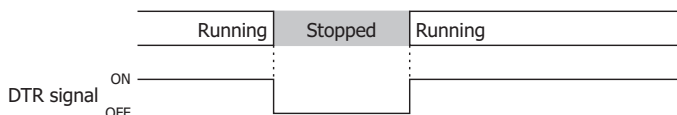

1 (01): Always off.

2 (10): Set this value when performing flow control for received data. The signal is on when data from the connected device can be received. The signal is off when data cannot be received.

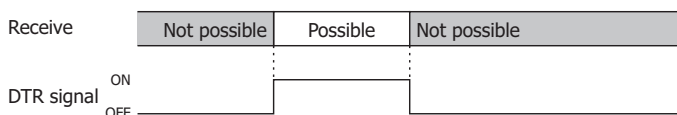

3 (11): The operation is the same as the setting "0".

■ **D8120, D8121: HMI Module Information**

HMI module type information is written to these registers. The allocation of information (bit assignment) is as follows.

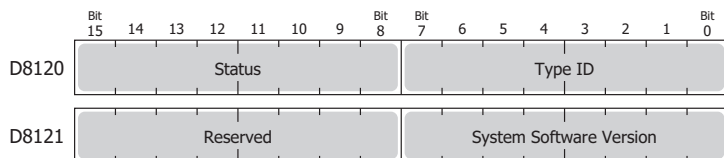

The system software version displays the version of the software written to the device. For details on the type IDs and statuses, see "List of Type IDs and Status" on page 6-49.

■ **D8122 to D8127: Cartridge Slot Information**

Cartridge Slot 1 to 3 information is written to these registers. The allocation of information (bit assignment) is as follows.

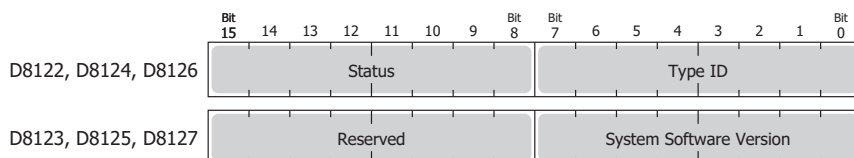

D8122, D8123 = Cartridge Slot 1 Information

D8124, D8125 = Cartridge Slot 2 Information

D8126, D8127 = Cartridge Slot 3 Information

For details on the type IDs and statuses, see "List of Type IDs and Status" on page 6-49.

■ **D8170, D8171, D8174, D8175, D8178, D8179: Analog I/O Cartridge I/O**

Analog I/O values for the analog I/O cartridges are written to these registers.

For the analog input type : The analog values input to the analog I/O cartridge are converted to digital values and written to the registers.

For the analog output type : The digital values stored as digital values are converted to analog values and output from the analog I/O cartridges.

For details, see "Analog I/O Cartridge" on page 10-7.

D8170 = AI2/AQ2

D8171 = AI3/AQ3

D8174 = AI4/AQ4

D8175 = AI5/AQ5

D8178 = AI6/AQ6

D8179 = AI7/AQ7

■ **D8172, D8173, D8176, D8177, D8180, D8181: Analog I/O Cartridge Status**

The analog status of analog I/O cartridges is written to these registers.

For details, see "Analog I/O Cartridge" on page 10-7.

D8172 = AI2/AQ2

D8173 = AI3/AQ3

D8176 = AI4/AQ4

D8177 = AI5/AQ5

D8180 = AI6/AQ6

D8181 = AI7/AQ7

■ **D8192 to D8203, D8210 to D8213, D8216 to D8229, D8232 to D8237: High-speed Counter**

These special data registers are used with the high-speed counter function and the frequency measurement function.

For details on high-speed counters, see "High-Speed Counter" on page 5-15.

D8210 to D8213, D8216, D8217 = High-speed counter (group 1/I0)

D8218 to D8221, D8234, D8235 = High-speed counter (group 3/I3)

D8222 to D8225, D8236, D8237 = High-speed counter (group 4/I4)

D8226 to D8229, D8232, D8233 = High-speed counter (group 5/I6)

D8192 to D8197 = High-speed counter (group 2/I1)

D8198 to D8203 = High-speed counter (group 6/I7)

■ **D8239: Absolute Position Control Status**

This register indicates the status of absolute position control.

The allocation of the absolute position counter initialized flags in the device (bit assignment) is as follows. For details on the absolute position control status, see Chapter 18 "ABS (Set Absolute Position)" in the "FC6A Series MICROSmart Ladder Programming Manual".

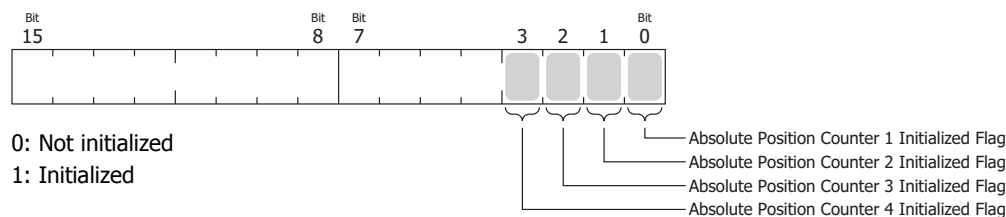

■ **D8240 to D8247: Absolute Position Counter 1 to 4**

The absolute position is written to these registers according to pulse output. The absolute position can be initialized with the ABS instruction.

When reversible control is set in the pulse output instructions (RAMP/ARAMP/ZRN/JOG), the absolute position is incremented or decremented according to the output result. For details on absolute position counters, see Chapter 18 "ABS (Set Absolute Position)" in the "FC6A Series MICROSmart Ladder Programming Manual".

D8240, D8241 = Absolute position counter 1

D8242, D8243 = Absolute position counter 2

D8244, D8245 = Absolute position counter 3

D8246, D8247 = Absolute position counter 4

■ **D8250: Read SD Memory Card Capacity**

This register indicates the capacity of the recognized SD or SDHC (maximum size 32 GB) memory card in megabytes. It is 0 when no SD memory card has been inserted or if it is not recognized.

■ **D8251: Read SD Memory Card Free Capacity**

This register indicates the free capacity of the SD memory card in megabytes. It is 0 when no SD memory card has been inserted or if it is not recognized.

■ **D8254: SD Memory Card Download/Upload Execution Information**

Information about the SD memory card download/upload that was executed. For details, see "SD Memory Card" on page 11-1.

■ **D8255: SD Memory Card Download/Upload Execution Status**

The status of the SD memory card download/upload that was executed. For details, see "SD Memory Card" on page 11-1.

■ **D8256: Download MQTT Basic Settings from SD Memory Card Execution Information**

Information in executing the download of the files for MQTT Basic Settings. The allocation of bits in the device (bit assignment) is as follows.

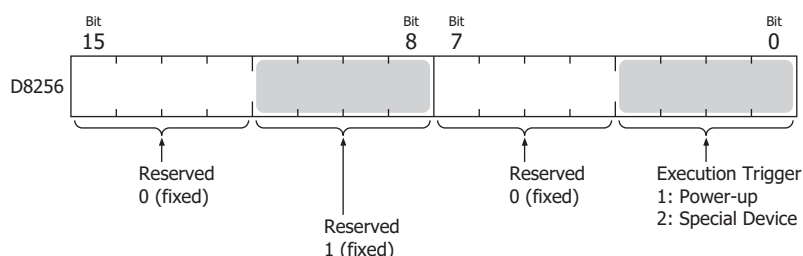

■ **D8257: Download MQTT Basic Settings from SD Memory Card Execution Error Information**

Error information in executing the download of the files for MQTT Basic Settings. For details, see "D8257: Download MQTT Basic Settings from SD Memory Card Execution Error Information" on page 11-47.

■ **D8260: Recipe Block Number**

The recipe block number to read or write using special internal relays. All channels for the specified block number are applicable.

■ **D8261: Recipe Execution Block Number**

The recipe block number of the recipe that was executed. This is updated when the recipe block starts, and the status is retained when completed.

■ **D8262: Recipe Execution Channel No.**

The channel number of the recipe that was executed. This is updated when the channel processing starts, and the status is retained when completed.

■ **D8263: Recipe Execution Operation**

Information about the operation of the recipe that was executed. For details on recipes, see "Recipe Function" on page 11-8.

■ **D8264: Recipe Execution Status**

The status of the recipe that was executed. For details on recipes, see "Recipe Function" on page 11-8.

■ **D8265: Recipe Execution Error Information**

Error information about the recipe that was executed. For details on recipes, see "Recipe Function" on page 11-8.

■ **D8266: Recipe Internal Memory (ROM-Range 1) Read Count**

The number of times device values are read to internal memory (ROM-Range 1) as recipe data is stored in this register in units of 100.

■ **D8267: Recipe Internal Memory (ROM-Range 2) Read Count**

The number of times device values are read to internal memory (ROM-Range 2) as recipe data is stored in this register in units of 100.

■ **D8268 to D8275, D8774 to D8781: Remote Host Number 1 to 255 (connection 1 to 16)**

Special data registers that change the communications device when user communications client is set. For details, see Chapter 5 "Switching Remote Host Numbers" in the "FC6A Series MICROSmart Communication Manual".

■ **D8278, D8279, D8760, D8761: Communication Mode Information (Client Connection) (Connection 1 to 16)**

D8278 = Indicates the communication mode of connections 1 through 4.

D8279 = Indicates the communication mode of connections 5 through 8.

D8760 = Indicates the communication mode of connections 9 through 12.

D8761 = Indicates the communication mode of connections 13 through 16.

The allocation of connections in the device (bit assignment) is as follows.

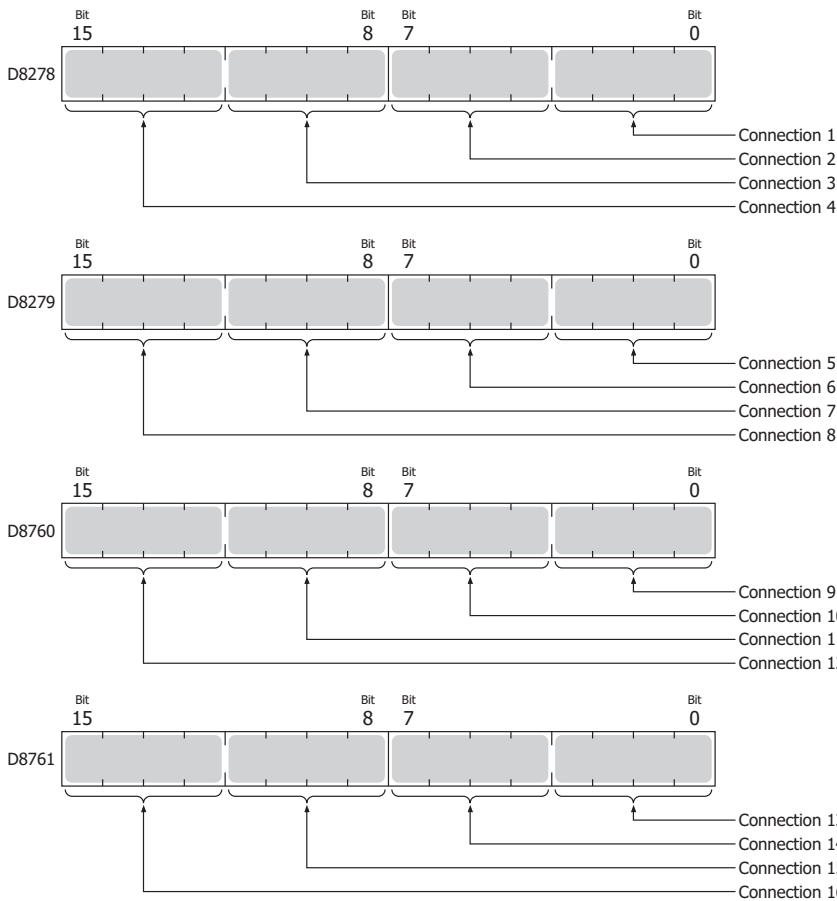

- Client connection (most significant bit = 0)
 - 0000: Unused
 - 0001: User Communication
 - 0010: Modbus TCP client
 - 0100: User communication UDP
- Server connection (most significant bit = 1)
 - 1000: Maintenance Communication
 - 1001: User Communication
 - 1010: Modbus TCP server

■ D8284, D8285: Communication Mode Information (HMI Connection) (HMI Connection 1 to 8)

D8284: Indicates the communication mode of HMI connections 1 through 4.

D8285: Indicates the communication mode of HMI connections 5 through 8.

The allocation of connections in the device (bit assignment) is as follows.

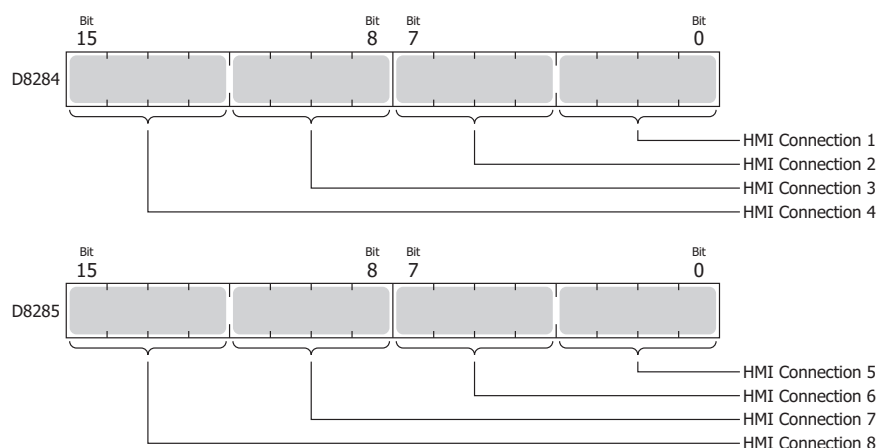

- Client connection (most significant bit = 0)
0000: Unused
- Server connection (most significant bit = 1)
1000: Maintenance Communication

■ D8303: CPU Module Ethernet Port 1 IP Settings/DNS Settings Switching

The IP settings/DNS settings for Ethernet Port 1 can be changed by writing one of the setting values in the table on the next page to D8303 and then turning on M8190.

To use this function, enable the following items in **Function Area Settings** of WindLDR.

- All-in-One CPU module/CAN J1939 All-in-One CPU module
Enable D8303 (IP Settings / DNS Settings switching) on Network Settings in Function Area Settings
- Plus CPU module
Enable D8303 (IP Settings / DNS Settings switching) on Ethernet Port 1 in Function Area Settings

The meanings of the setting values are as follows.

Setting Value	IP Settings/DNS Settings
0	Conform to function area settings.
1	Enable DHCP.
2	Conform to special data register (D8304 to D8323) settings.

■ D8304 to D8307: CPU Module Ethernet Port 1 IP Address (Write-only)

These registers are used to write the CPU module's IP address.

IP address: To set as aaa.bbb.ccc.ddd, write the following.

D8304=aaa, D8305=bbb, D8306=ccc, D8307=ddd

■ D8308 to D8311: CPU Module Ethernet Port 1 Subnet Mask (Write-only)

These registers are used to write the CPU module's subnet mask.

Subnet mask: For aaa.bbb.ccc.ddd, write the following.

D8308=aaa, D8309=bbb, D8310=ccc, D8311=ddd

■ D8312 to D8315: CPU Module Ethernet Port 1 Default Gateway (Write-only)

These registers are used to write the CPU module's default gateway.

Default gateway: For aaa.bbb.ccc.ddd, write the following.

D8312=aaa, D8313=bbb, D8314=ccc, D8315=ddd

■ D8316 to D8319: CPU Module Ethernet Port 1 Preferred DNS Server (Write-only)

These registers are used to write the CPU module's preferred DNS server.

Preferred DNS server: For aaa.bbb.ccc.ddd, write the following.

D8316=aaa, D8317=bbb, D8318=ccc, D8319=ddd

■ **D8320 to D8323: CPU Module Ethernet Port 1 Alternate DNS Server (Write-only)**

These registers are used to write the CPU module's alternate DNS server.

Alternate DNS server: For aaa.bbb.ccc.ddd, write the following.

D8320=aaa, D8321=bbb, D8322=ccc, D8323=ddd

■ **D8324 to D8329: CPU Module Ethernet Port 1 MAC Address (Current Value Read-only)**

The CPU module's MAC address is written to the special data registers as follows.

Example: MAC address: AA-BB-CC-DD-EE-FF

D8324=AA, D8325=BB, D8326=CC, D8327=DD, D8328=EE, D8329=FF

■ **D8330 to D8333: CPU Module Ethernet Port 1 IP Address (Current Value Read-only)**

The CPU module's IP address is written to the special data registers as follows.

Example: The CPU module's own IP address aaa.bbb.ccc.ddd

D8330=aaa, D8331=bbb, D8332=ccc, D8333=ddd

■ **D8334 to D8337: CPU Module Ethernet Port 1 Subnet Mask (Current Value Read-only)**

The CPU module's subnet mask value is written to the special data registers as follows.

Example: Subnet mask: aaa.bbb.ccc.ddd

D8334=aaa, D8335=bbb, D8336=ccc, D8337=ddd

■ **D8338 to D8341: CPU Module Ethernet Port 1 Default Gateway (Current Value Read-only)**

The CPU module's default gateway address is written to the special data registers as follows.

Example: Default gateway: aaa.bbb.ccc.ddd

D8338=aaa, D8339=bbb, D8340=ccc, D8341=ddd

■ **D8342 to D8345: CPU Module Ethernet Port 1 Preferred DNS Server (Current Value Read-only)**

The CPU module's preferred DNS server address is written to the special data registers as follows.

Example: Preferred DNS server: aaa.bbb.ccc.ddd

D8342=aaa, D8343=bbb, D8344=ccc, D8345=ddd

■ **D8346 to D8349: CPU Module Ethernet Port 1 Alternate DNS Server (Current Value Read-only)**

The CPU module's alternate DNS server address is written to the special data registers as follows.

Example: Alternate DNS server: aaa.bbb.ccc.ddd

D8346=aaa, D8347=bbb, D8348=ccc, D8349=ddd

■ **D8350 to D8381, D8677 to D8708: Connection Connected IP Address**

The IP address of the connected device that is being accessed through a connection is written as follows.

Connection 1 Connected IP Address: For aaa.bbb.ccc.ddd

D8350=aaa, D8351=bbb, D8352=ccc, D8353=ddd

Connection 2 Connected IP Address: For aaa.bbb.ccc.ddd

D8354=aaa, D8355=bbb, D8356=ccc, D8357=ddd

Connection 3 Connected IP Address: For aaa.bbb.ccc.ddd

D8358=aaa, D8359=bbb, D8360=ccc, D8361=ddd

Connection 4 Connected IP Address: For aaa.bbb.ccc.ddd

D8362=aaa, D8363=bbb, D8364=ccc, D8365=ddd

Connection 5 Connected IP Address: For aaa.bbb.ccc.ddd

D8366=aaa, D8367=bbb, D8368=ccc, D8369=ddd

Connection 6 Connected IP Address: For aaa.bbb.ccc.ddd

D8370=aaa, D8371=bbb, D8372=ccc, D8373=ddd

Connection 7 Connected IP Address: For aaa.bbb.ccc.ddd

D8374=aaa, D8375=bbb, D8376=ccc, D8377=ddd

Connection 8 Connected IP Address: For aaa.bbb.ccc.ddd

D8378=aaa, D8379=bbb, D8380=ccc, D8381=ddd

Connection 9 Connected IP Address: For aaa.bbb.ccc.ddd

D8677=aaa, D8678=bbb, D8679=ccc, D8680=ddd

Connection 10 Connected IP Address: For aaa.bbb.ccc.ddd

D8681=aaa, D8682=bbb, D8683=ccc, D8684=ddd

Connection 11 Connected IP Address: For aaa.bbb.ccc.ddd

D8685=aaa, D8686=bbb, D8687=ccc, D8688=ddd

Connection 12 Connected IP Address: For aaa.bbb.ccc.ddd

D8689=aaa, D8690=bbb, D8691=ccc, D8692=ddd
 Connection 13 Connected IP Address: For aaa.bbb.ccc.ddd
 D8693=aaa, D8694=bbb, D8695=ccc, D8696=ddd
 Connection 14 Connected IP Address: For aaa.bbb.ccc.ddd
 D8697=aaa, D8698=bbb, D8699=ccc, D8700=ddd
 Connection 15 Connected IP Address: For aaa.bbb.ccc.ddd
 D8701=aaa, D8702=bbb, D8703=ccc, D8704=ddd
 Connection 16 Connected IP Address: For aaa.bbb.ccc.ddd
 D8705=aaa, D8706=bbb, D8707=ccc, D8708=ddd

■ **D8382 to D8387: HMI Module MAC Address (Current Value Read-only)**

The MAC address is written to the special data registers as follows.

Example: MAC address: AA-BB-CC-DD-EE-FF

D8382=AA, D8383=BB, D8384=CC, D8385=DD, D8386=EE, D8387=FF

■ **D8388 to D8391: HMI Module IP Address (Current Value Read-only)**

The HMI module's IP address is written to the special data registers as follows.

Example: HMI module IP address: aaa.bbb.ccc.ddd

D8388=aaa, D8389=bbb, D8390=ccc, D8391=ddd

■ **D8392 to D8395: HMI Module Subnet Mask (Current Value Read-only)**

The HMI module's subnet mask value is written to the special data registers as follows.

Example: HMI module subnet mask: aaa.bbb.ccc.ddd

D8392=aaa, D8393=bbb, D8394=ccc, D8395=ddd

■ **D8396 to D8399: HMI Module Default Gateway (Current Value Read-only)**

The HMI module's default gateway address is written to the special data registers as follows.

Example: HMI module default gateway: aaa.bbb.ccc.ddd

D8396=aaa, D8397=bbb, D8398=ccc, D8399=ddd

■ **D8400 to D8403: HMI Module Preferred DNS Server (Current Value Read-only)**

The HMI module's preferred DNS server address is written to the special data registers as follows.

Example: HMI module preferred DNS server: aaa.bbb.ccc.ddd

D8400=aaa, D8401=bbb, D8402=ccc, D8403=ddd

■ **D8404 to D8407: HMI Module Alternate DNS Server (Current Value Read-only)**

The HMI module's alternate DNS server address is written to the special data registers as follows.

Example: HMI module alternate DNS server: aaa.bbb.ccc.ddd

D8404=aaa, D8405=bbb, D8406=ccc, D8407=ddd

■ **D8413: Time Zone Offset**

The time zone configured in the function area settings can be finely adjusted in 15-minute increments.

For details, see Chapter 3 "SNTP Settings" in the "FC6A Series MICROSmart Communication Manual".

■ **D8414: SNTP Operation Status**

The operation status is written to this register when the time information is acquired through operation of M8191 (SNTP Time Acquisition Flag) or when time information acquisition was executed by automatic acquisition.

For details, see Chapter 3 "SNTP Settings" in the "FC6A Series MICROSmart Communication Manual".

■ **D8415: SNTP Access Elapsed Time**

The elapsed time in minutes from when the time information was last acquired from the SNTP server.

For details, see Chapter 3 "SNTP Settings" in the "FC6A Series MICROSmart Communication Manual".

■ **D8429: HMI Module Connection Information Reference Connection Number**

The connection information for the specified connection number is reflected in D8430 to D8434. When 0 is written, 0 is written to D8430 to D8434. If a connection number that does not exist is specified, 0 is written to D8430 to D8434.

■ **D8430 to D8433: HMI Module Connection Information Reference Connected IP Address**

The IP address of the terminal being accessed through the connection is written to the special data registers as follows.

Example: IP address to read: aaa.bbb.ccc.ddd

D8430=aaa, D8431=bbb, D8432=ccc, D8433=ddd

■ **D8434: HMI Module Connection Information Reference Connected Port No.**

The port number of the terminal being accessed through the connection is written to this register.

■ **D8437 to D8440: HMI Module IP Address (Write-only)**

These registers are used to write the HMI module's IP address.
 HMI module IP address: To set as aaa.bbb.ccc.ddd, write the following.
 D8437=aaa, D8438=bbb, D8439=ccc, D8440=ddd

■ **D8441 to D8444: HMI Module Subnet Mask (Write-only)**

These registers are used to write the HMI module's subnet mask.
 HMI module subnet mask: For aaa.bbb.ccc.ddd, write the following.
 D8441=aaa, D8442=bbb, D8443=ccc, D8444=ddd

■ **D8445 to D8448: HMI Module Default Gateway (Write-only)**

These registers are used to write the HMI module's default gateway.
 HMI module default gateway: For aaa.bbb.ccc.ddd, write the following.
 D8445=aaa, D8446=bbb, D8447=ccc, D8448=ddd

■ **D8449 to D8452: HMI Module Preferred DNS Server (Write-only)**

These registers are used to write the HMI module's preferred DNS server.
 HMI module preferred DNS server: For aaa.bbb.ccc.ddd, write the following.
 D8449=aaa, D8450=bbb, D8451=ccc, D8452=ddd

■ **D8453 to D8456: HMI Module Alternate DNS Server (Write-only)**

These registers are used to write the HMI module's alternate DNS server.
 HMI module alternate DNS server: For aaa.bbb.ccc.ddd, write the following.
 D8453=aaa, D8454=bbb, D8455=ccc, D8456=ddd

■ **D8457: EMAIL Instruction Detailed Error Information (HMI-Ethernet Port)**

Detailed error information for the EMAIL instruction is written to this register.
 For details, see Chapter 12 "Confirm the error detail of EMAIL instruction" in the "FC6A Series MICROSmart Communication Manual".

■ **D8470 to D8595: Expansion Module Slot Information**

Expansion module type information is written to these registers.
 The allocation of information (bit assignment) is as follows.

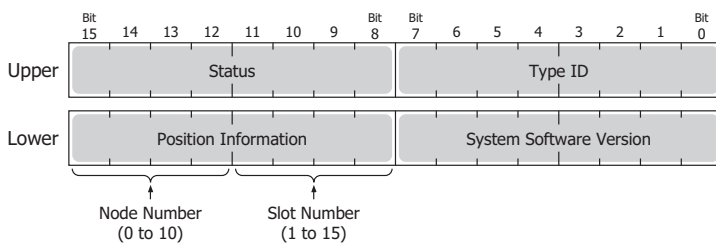

- | | |
|--------------|--|
| Upper | Lower |
| D8470, D8471 | = Expansion Module Slot 1 Information |
| D8472, D8473 | = Expansion Module Slot 2 Information |
| D8474, D8475 | = Expansion Module Slot 3 Information |
| D8476, D8477 | = Expansion Module Slot 4 Information |
| D8478, D8479 | = Expansion Module Slot 5 Information |
| D8480, D8481 | = Expansion Module Slot 6 Information |
| D8482, D8483 | = Expansion Module Slot 7 Information |
| D8484, D8485 | = Expansion Module Slot 8 Information |
| D8486, D8487 | = Expansion Module Slot 9 Information |
| D8488, D8489 | = Expansion Module Slot 10 Information |
| D8490, D8491 | = Expansion Module Slot 11 Information |
| D8492, D8493 | = Expansion Module Slot 12 Information |
| D8494, D8495 | = Expansion Module Slot 13 Information |
| D8496, D8497 | = Expansion Module Slot 14 Information |

Upper	Lower	
D8498	D8499	= Expansion Module Slot 15 Information
D8500	D8501	= Expansion Module Slot 16 Information
D8502	D8503	= Expansion Module Slot 17 Information
D8504	D8505	= Expansion Module Slot 18 Information
D8506	D8507	= Expansion Module Slot 19 Information
D8508	D8509	= Expansion Module Slot 20 Information
D8510	D8511	= Expansion Module Slot 21 Information
D8512	D8513	= Expansion Module Slot 22 Information
D8514	D8515	= Expansion Module Slot 23 Information
D8516	D8517	= Expansion Module Slot 24 Information
D8518	D8519	= Expansion Module Slot 25 Information
D8520	D8521	= Expansion Module Slot 26 Information
D8522	D8523	= Expansion Module Slot 27 Information
D8524	D8525	= Expansion Module Slot 28 Information
D8526	D8527	= Expansion Module Slot 29 Information
D8528	D8529	= Expansion Module Slot 30 Information
D8530	D8531	= Expansion Module Slot 31 Information
D8532	D8533	= Expansion Module Slot 32 Information
D8534	D8535	= Expansion Module Slot 33 Information
D8536	D8537	= Expansion Module Slot 34 Information
D8538	D8539	= Expansion Module Slot 35 Information
D8540	D8541	= Expansion Module Slot 36 Information
D8542	D8543	= Expansion Module Slot 37 Information
D8544	D8545	= Expansion Module Slot 38 Information
D8546	D8547	= Expansion Module Slot 39 Information
D8548	D8549	= Expansion Module Slot 40 Information
D8550	D8551	= Expansion Module Slot 41 Information
D8552	D8553	= Expansion Module Slot 42 Information
D8554	D8555	= Expansion Module Slot 43 Information
D8556	D8557	= Expansion Module Slot 44 Information
D8558	D8559	= Expansion Module Slot 45 Information
D8560	D8561	= Expansion Module Slot 46 Information
D8562	D8563	= Expansion Module Slot 47 Information
D8564	D8565	= Expansion Module Slot 48 Information
D8566	D8567	= Expansion Module Slot 49 Information
D8568	D8569	= Expansion Module Slot 50 Information
D8570	D8571	= Expansion Module Slot 51 Information
D8572	D8573	= Expansion Module Slot 52 Information
D8574	D8575	= Expansion Module Slot 53 Information
D8576	D8577	= Expansion Module Slot 54 Information
D8578	D8579	= Expansion Module Slot 55 Information
D8580	D8581	= Expansion Module Slot 56 Information
D8582	D8583	= Expansion Module Slot 57 Information
D8584	D8585	= Expansion Module Slot 58 Information
D8586	D8587	= Expansion Module Slot 59 Information
D8588	D8589	= Expansion Module Slot 60 Information

Upper Lower

- D8590, D8591 = Expansion Module Slot 61 Information
- D8592, D8593 = Expansion Module Slot 62 Information
- D8594, D8595 = Expansion Module Slot 63 Information

The system software version displays the version of the software written to the device.
 For details on the type IDs and statuses, see "List of Type IDs and Status" on page 6-49.

■ **D8596, D8597: Expansion Interface Remote Master Module Slot Information**

Expansion interface remote master module type information is written to these registers.
 The allocation of information (bit assignment) is as follows.

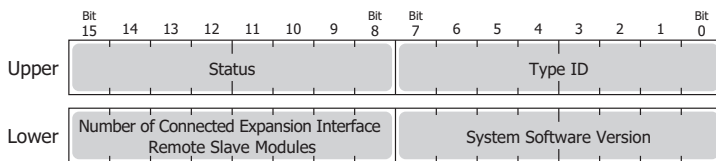

The system software version displays the version of the software written to the device.
 For details on the type IDs and statuses, see "List of Type IDs and Status" on page 6-49.

■ **D8598 to D8617: Expansion Interface Remote Slave Module Slot Information**

Expansion interface remote slave module type information is written to these registers.
 The allocation of information (bit assignment) is as follows.

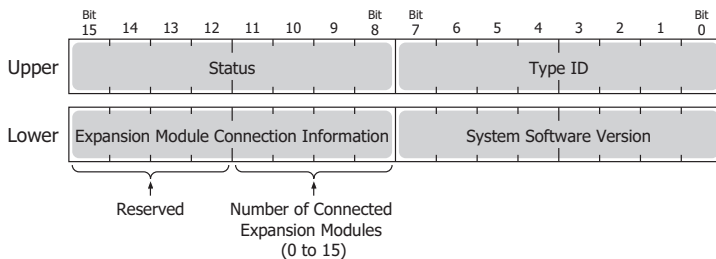

Upper Lower

- D8598, D8599 = Expansion Interface Remote Slave Module (Unit 1) Slot Information
- D8600, D8601 = Expansion Interface Remote Slave Module (Unit 2) Slot Information
- D8602, D8603 = Expansion Interface Remote Slave Module (Unit 3) Slot Information
- D8604, D8605 = Expansion Interface Remote Slave Module (Unit 4) Slot Information
- D8606, D8607 = Expansion Interface Remote Slave Module (Unit 5) Slot Information
- D8608, D8609 = Expansion Interface Remote Slave Module (Unit 6) Slot Information
- D8610, D8611 = Expansion Interface Remote Slave Module (Unit 7) Slot Information
- D8612, D8613 = Expansion Interface Remote Slave Module (Unit 8) Slot Information
- D8614, D8615 = Expansion Interface Remote Slave Module (Unit 9) Slot Information
- D8616, D8617 = Expansion Interface Remote Slave Module (Unit 10) Slot Information

The system software version displays the version of the software written to the device.
 For details on the type ID and status, see "List of Type IDs and Status" on page 6-49.

■ **D8618: Refresh Time of Expansion Interface Remote Master/Slave Modules Current Value**

The current value of the I/O refresh time of the expansion modules connected with the expansion interface remote master/slave modules is stored in increments of 1 ms.

■ **D8619: Refresh Time of Expansion Interface Remote Master/Slave Modules Maximum Value**

The maximum value of the I/O refresh time of the expansion modules connected with the expansion interface remote master/slave modules is stored in increments of 1 ms.

■ D8630: CPU Module Ethernet Port 2 IP Settings/DNS Settings Switching

The IP settings/DNS settings for Ethernet Port 2 can be changed by writing one of the setting values in the following table to D8630 and then turning on M8333.

To use this function, enable **Enable D8630 (IP Settings / DNS Settings switching)** on **Ethernet Port 2** in **Function Area Settings** of WindLDR.

The meanings of the setting values are as follows.

Setting Value	IP Settings/DNS Settings
0	Conform to function area settings.
1	Enable DHCP.
2	Conform to special data register (D8631 to D8650) settings.

■ D8631 to D8634: CPU Module Ethernet Port 2 IP Address (Write-only)

These registers are used to write the IP address of Ethernet port 2 on the Plus CPU module.

IP address: To set as aaa.bbb.ccc.ddd, write the following.

D8631 = aaa, D8632 = bbb, D8633 = ccc, D8634 = ddd

■ D8635 to D8638: CPU Module Ethernet Port 2 Subnet Mask (Write-only)

These registers are used to write the subnet mask of Ethernet port 2 on the Plus CPU module.

Subnet mask: For aaa.bbb.ccc.ddd, write the following.

D8635 = aaa, D8636 = bbb, D8637 = ccc, D8638 = ddd

■ D8639 to D8642: CPU Module Ethernet Port 2 Default Gateway (Write-only)

These registers are used to write the default gateway of Ethernet port 2 on the Plus CPU module.

Default gateway: For aaa.bbb.ccc.ddd, write the following.

D8639 = aaa, D8640 = bbb, D8641 = ccc, D8642 = ddd

■ D8643 to D8646: CPU Module Ethernet Port 2 Preferred DNS Server (Write-only)

These registers are used to write the preferred DNS server of Ethernet port 2 on the Plus CPU module.

Preferred DNS server: For aaa.bbb.ccc.ddd, write the following.

D8643 = aaa, D8644 = bbb, D8645 = ccc, D8646 = ddd

■ D8647 to D8650: CPU Module Ethernet Port 2 Alternate DNS Server (Write-only)

These registers are used to write the alternate DNS server of Ethernet port 2 on the Plus CPU module.

Alternate DNS server: For aaa.bbb.ccc.ddd, write the following.

D8647 = aaa, D8648 = bbb, D8649 = ccc, D8650 = ddd

■ D8651 to D8656: CPU Module Ethernet Port 2 MAC Address (Current Value Read-only)

The MAC address of Ethernet port 2 on the Plus CPU module is written to the special data registers as follows.

Example: MAC address: AA-BB-CC-DD-EE-FF

D8651 = AA, D8652 = BB, D8653 = CC, D8654 = DD, D8655 = EE, D8656 = FF

■ D8657 to D8660: CPU Module Ethernet Port 2 IP Address (Current Value Read-only)

The IP address of Ethernet port 2 on the Plus CPU module is written to the special data registers as follows.

Example: The CPU module's own IP address: aaa.bbb.ccc.ddd

D8657 = aaa, D8658 = bbb, D8659 = ccc, D8660 = ddd

■ D8661 to D8664: CPU Module Ethernet Port 2 Subnet Mask (Current Value Read-only)

The subnet mask value of Ethernet port 2 on the Plus CPU module is written to the special data registers as follows.

Example: Subnet mask: aaa.bbb.ccc.ddd

D8661 = aaa, D8662 = bbb, D8663 = ccc, D8664 = ddd

■ D8665 to D8668: CPU Module Ethernet Port 2 Default Gateway (Current Value Read-only)

The default gateway address of Ethernet port 2 on the Plus CPU module is written to the special data registers as follows.

Example: Default gateway: aaa.bbb.ccc.ddd

D8665 = aaa, D8666 = bbb, D8667 = ccc, D8668 = ddd

■ **D8669 to D8672: CPU Module Ethernet Port 2 Preferred DNS Server (Current Value Read-only)**

The preferred DNS server address of Ethernet port 2 on the Plus CPU module is written to the special data registers as follows.

Example: Preferred DNS server: aaa.bbb.ccc.ddd

D8669 = aaa, D8670 = bbb, D8671 = ccc, D8672 = ddd

■ **D8673 to D8676: CPU Module Ethernet Port 2 Alternate DNS Server (Current Value Read-only)**

The alternate DNS server address of Ethernet port 2 on the Plus CPU module is written to the special data registers as follows.

Example: Alternate DNS server: aaa.bbb.ccc.ddd

D8673 = aaa, D8674 = bbb, D8675 = ccc, D8676 = ddd

■ **D8759: EMAIL Instruction Detailed Error Information (Ethernet Port 1)**

Detailed error information for the EMAIL instruction (Ethernet port 1) is written to this register.

For details, see Chapter 12 "Confirm the error detail of EMAIL instruction" in the "FC6A Series MICROSmart Communication Manual".

■ **D8782: BACnet Operation Status**

The operating status of BACnet communication is written to this special data register.

For details, see Chapter 15 "Special Devices Used in BACnet/IP" in the "FC6A Series MICROSmart Communication Manual".

■ **D8783: BACnet Error Information**

Information for the error that last occurred in BACnet communication is written to this special data register.

For details, see Chapter 15 "Special Devices Used in BACnet/IP" in the "FC6A Series MICROSmart Communication Manual".

■ **D8790: EtherNet/IP Operation Status**

The operating status of EtherNet/IP communication is written to this special data register.

For details, see Chapter 16 "Special Devices Used in EtherNet/IP Communication" in the "FC6A Series MICROSmart Communication Manual".

■ **D8791: EtherNet/IP Error Information**

Information for the error that last occurred in EtherNet/IP communication is written to this special data register.

For details, see Chapter 16 "Special Devices Used in EtherNet/IP Communication" in the "FC6A Series MICROSmart Communication Manual".

List of Type IDs and Status

■ Type ID

Expansion module and HMI module

Type ID		Type No.
Hexadecimal	Binary	
0x00	0000 0000	FC6A-N16B1, FC6A-N16B4, FC6A-N16B3
0x01	0000 0001	FC6A-R161, FC6A-R164, FC6A-T16K1, FC6A-T16K4, F6A-T16P1, FC6A-T16P4, F6A-T16K3, FCA-T16P3
0x02	0000 0010	FC6A-N32B3
0x03	0000 0011	FC6A-T32K3, FC6A-T32P3
0x04	0000 0100	FC6A-N08B1, FC6A-N08B4, FC6A-N08A11, FC6A-N08A14
0x05	0000 0101	FC6A-R081, FC6A-R084, FC6A-T08K1, FC6A-T08K4, FC6A-T08P1, FC6A-T08P4
0x06	0000 0110	FC6A-M08BR1, FC6A-M08BR4
0x07	0000 0111	FC6A-M24BR1, FC6A-M24BR4
0x18	0001 1000	FC6A-PH1
0x19	0001 1001	FC6A-EXM2, FC6A-EXM24
0x1A	0001 1010	FC6A-EXM1S, FC6A-EXM1S4
0x20	0010 0000	FC6A-J2C1, FC6A-J2C4
0x21	0010 0001	FC6A-J4A1, FC6A-J4A4
0x22	0010 0010	FC6A-J8A1, FC6A-J8A4
0x23	0010 0011	FC6A-K2A1, FC6A-K2A4
0x24	0010 0100	FC6A-K4A1, FC6A-K4A4
0x25	0010 0101	FC6A-L06A1, FC6A-L06A4
0x26	0010 0110	FC6A-L03CN1, FC6A-L03CN4
0x27	0010 0111	FC6A-J4CN1, FC6A-J4CN4
0x28	0010 1000	FC6A-J8CU1, FC6A-J8CU4
0x29	0010 1001	FC6A-F2M1, FC6A-F2M4
0x2A	0010 1010	FC6A-F2MR1, FC6A-F2MR4
0x2B	0010 1011	FC6A-J4CH1Y, FC6A-J4CH4Y
0x2C	0010 1100	FC6A-EXM1M
0x2E	0010 1110	FC6A-SIF52, FC6A-SIF524
0xFF	1111 1111	Not connected

Cartridge

Type ID		Type No.
Hexadecimal	Binary	
0x00	0000 0000	FC6A-PJ2A
0x01	0000 0001	FC6A-PK2AV
0x02	0000 0010	FC6A-PK2AW
0x03	0000 0011	FC6A-PJ2CP
0x06	0000 0110	FC6A-PC1
0x07	0000 0111	FC6A-PC3
0x09	0000 1001	FC6A-PTS4, FC6A-PTK4
0x0A	0000 1010	FC6A-PN4
0x0C	0000 1100	FC6A-PC4
0xFF	1111 1111	Not connected

■ Status

Status		Description
Hexadecimal	Binary	
0x00	0000 0000	Normal
0x81	1000 0001	Communication error (An error has occurred in the communication between the CPU module and an expansion module, HMI module, or cartridge.)
0x82	1000 0010	Unknown device detected (A device other than the FC6A Series MICROSmart is connected.)
0x83	1000 0011	Device setting error (No device is connected or the connected device is different from that set in the user program.)
0x84	1000 0100	Device writing error (The attempt to set the operation of the device failed.)
0x85	1000 0101	System update error (The system update failed.)

6: DEVICES

Status		Description
Hexadecimal	Binary	
0x86	1000 0110	Expansion interface remote master module communication error (An error is occurring in the communication between the expansion interface remote master and slave modules.)

7: HMI FUNCTION

Introduction

This chapter describes the functions that can be used with the HMI module connected to the CPU module and their operating procedures.

HMI Function Overview

This section describes an overview of the HMI module and functions that can be used.

The HMI Module

With the HMI module, you can run and stop the user program, monitor and modify device values, and configure the environment settings on the FC6A Series MICROSmart without using WindLDR by using the HMI module LCD and operation buttons on the module. With Ethernet communication, the web server function and the send e-mail function can be used. The HMI module can also relay CPU module Ethernet communication using a maximum of eight connections.

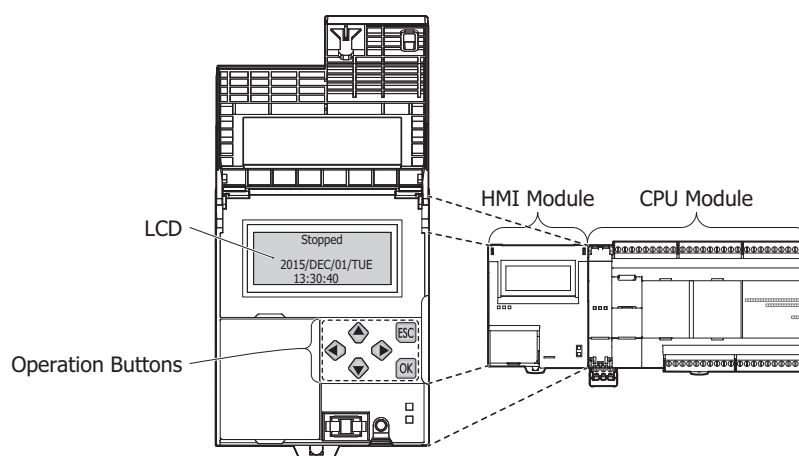

HMI Functions List

■ System menu functions

The following functions can be used with the HMI module's LCD display function and button operations.

Type	Function		Description	Reference
Run/stop Operation	Switching run/stop		Switches the program run status (RUN/STOP).	7-9
Edit Program	Confirming/Clearing changed timer/counter preset values		Change timer/counter preset values or writes them to the user program in the ROM.	7-10
Configurations	Environment Settings	Slave Number/ Network Settings/ Message Scroll/Blink Menu Language/ LCD Backlight ON Time	Some of the function area settings (slave number, network settings, message scroll speed, scroll unit, blinking speed, and LCD backlight ON time) can be modified. The system menu language can also be changed.	7-12
	Calendar/Clock		Configures the calendar/time for the internal clock.	7-31
Monitors	Device Monitor		Displays/modifies the specified device values.	7-32
	Status Monitor		Displays the system software version, operating status, scan time, protection status, and network settings.	7-35
	Error Monitor		Allows you to check errors that have occurred.	7-38
Message Display	Message Display		Displays the screen configured by the MSG instruction on the LCD.	7-40
SD Memory Card	Stop Access		Stops access to the SD memory card in order to remove it.	7-41
	Format		Formats the SD memory card.	7-42
	Recipe Operations		Recipe files can be read from and written to the SD memory card.	7-43
	Downloading/Uploading User Programs		The user program can be downloaded and uploaded.	7-45

7: HMI FUNCTION

■ Communication Functions

Type	Function	Details	Reference
Ethernet Communication	Connection Settings	CPU module communication can be relayed using a maximum of eight connections.	7-48
	Send E-mail	E-mails can be sent with the EMAIL instruction.	7-48
	Web Server	The HMI module status can be checked and the content of devices can be changed using a web browser.	7-48

■ Cartridges

Function	Details	Reference
Digital I/O Cartridge	One digital I/O cartridge can be installed in the HMI module.	10-1
Analog I/O Cartridge	One analog I/O cartridge can be installed in the HMI module.	10-7
Communication Cartridge	One communication cartridge can be installed in the HMI module. Plus CPU module only.	2-173

LCD Settings

You can change the HMI module LCD settings in the module configuration editor.

For details on the module configuration editor, see "Module Configuration Editor Overview" on page 12-1.

Backlight Settings

If you select **Always On** in the **Backlight Settings**, the LCD backlight will remain on at all times. If you select **Turn off in**, the LCD backlight turns on when an HMI module operation button is pressed and automatically turns off if no operation buttons are pressed for a certain amount of time. Set the time until the backlight automatically turns off to a value in the range of 1 to 65,535 seconds.

The backlight on time can also be changed with the system menu environment settings. If you set the time to 0, the backlight will remain on at all times in the same manner as when **Always On** is selected. For details, see "Setting the LCD Backlight ON Time" on page 7-13.

Message Settings

These are settings related to the messages displayed on the LCD.

When you execute the MSG instruction, the set message is displayed on the LCD. Set the character set, scroll unit, scroll speed, and blink speed of the displayed message.

For details on MSG Instruction, see Chapter 12 "MSG Instruction Common Settings" in the "FC6A Series MICROSmart Ladder Programming Manual".

■ Character Set

This is the character set used in the messages displayed with the MSG instruction. Select from the following.

Selection	Character Set	Languages Usable in the MSG Instruction
European	ISO-8859-1 (Latin 1)	Italian, English, Dutch, Spanish, German, French
Japanese	Shift-JIS	Japanese (level 1)
Chinese	GB2312	Chinese (simplified)
Cyrillic	ANSI1251	Russian

■ Scroll Unit

This is the unit with which the messages displayed with the MSG instruction are scrolled. Select from the following.

Selection	Description
1 character	Scrolls the text in 1 character units.
1 dot	Scrolls the text in 1 dot units.

■ Scroll Speed

This is the speed with which the messages displayed with the MSG instruction are scrolled. Select from the following.

"500 ms", "600 ms", "700 ms", "800 ms", "900 ms", "1000 ms"

■ Blink Speed

This is the speed with which the messages displayed with the MSG instruction blink or inverted. Select from the following.

"500 ms", "600 ms", "700 ms", "800 ms", "900 ms", "1000 ms"

Options

These are settings related to the overall display of the HMI module.

■ Menu Language

This is the language of the menus displayed on the LCD. Select from the following.

"Japanese", "English", "Chinese"

Programming WindLDR

This section describes how to use the WindLDR module configuration editor to set the LCD.

1. From the WindLDR menu bar, select **Configuration > Expansion Modules**.
2. Click the inserted HMI module in the module configuration area and click **Configure**.
The **HMI Module Configuration** dialog box is displayed.
3. Click **LCD Settings**.

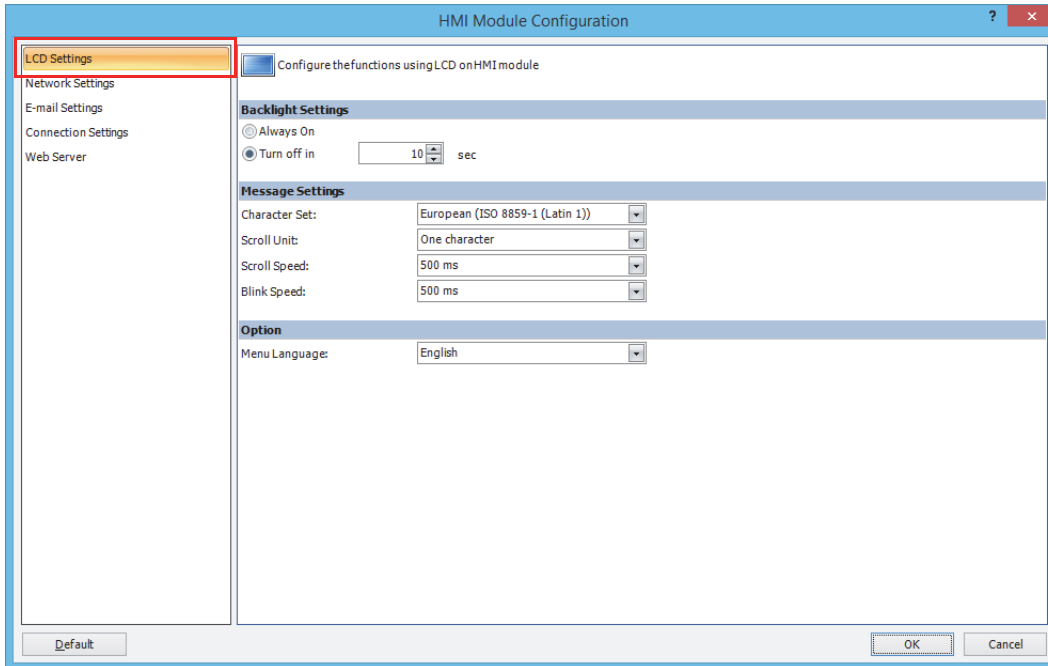

4. Configure the settings in **Backlight Settings**, **Message Settings**, and **Options**.
5. Click **OK**.

This concludes configuring the settings.

About the Menu Screen

This section describes the menu screen displayed on the HMI module LCD.

When switching from the standard screen to the system menu screen, the menu items are displayed on the LCD.

Standard Screen

The standard screen is the screen that is displayed after the FC6A Series MICROSmart is turned on. It displays the operation status (run/stopped) and the current date and time.

In the initial state, the English screen in the following diagram is displayed when the power is first turned on. To switch to the Japanese menu, see "Changing the Menu Language" on page 7-12.

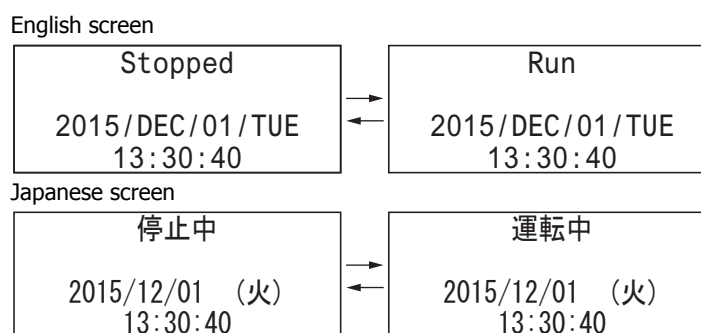

System Menu

On the standard screen, press the **ESC** (ESC) button while pressing the **OK** (OK) button to display the system menu.

You can execute operations, such as running and stopping the user program, monitoring devices, and modifying the settings, on the system menu. The menu items displayed on the LCD differ according to the operating status (running/stopped) of the user program.

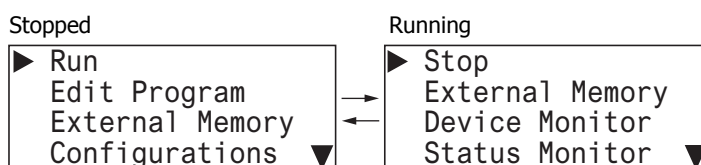

■ System Menu when FC6A Series MICROSmart is stopped

The menu items displayed while the user program is stopped are as follows.

- Run
- Edit Program
- External Memory
- Configurations
- Device Monitor
- Status Monitor
- Error Status

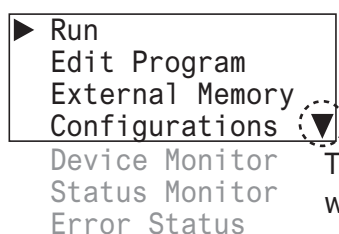

The ▼ symbol is displayed when menu items continue below.

■ System Menu while FC6A Series MICROSmart is running

The menu items displayed while the user program is running are as follows.

- Stop
- External Memory
- Device Monitor
- Status Monitor
- Error Status

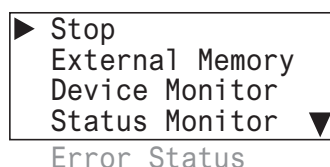

Message Screen

The FC6A Series MICROSmart can display messages on the HMI module LCD using the MSG (message) instruction. While the user program is running, the message is displayed when the input conditions of MSG (message) instructions are ON. Multiple message screens with different priorities can be switched and displayed with the **▲** (up) and **▼** (down) buttons.

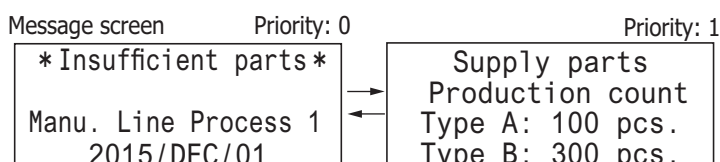

Basic Operations

This section describes basic operation methods for the HMI module buttons.

The HMI module has the (up), (down), (left), (right), (ESC), and (OK) buttons, and these buttons are used to operate the screens displayed on the LCD.

Pushing the Switches

The operation of the buttons differs by how they are pressed. There are two ways to push the buttons, which are detailed below.

Press/Hold	Operation
Press	The switch is pressed for 0.1 seconds or more and less than three seconds and then released.
Press and hold	The switch is pressed for three seconds or more and then released.

■ (up), (down) buttons

Moves the cursor up and down to select menu items. These buttons are also used to change numeric values.

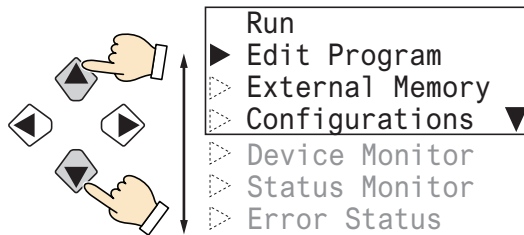

■ (left), (right) buttons

Moves the cursor left and right. These buttons are also used to move the digit.

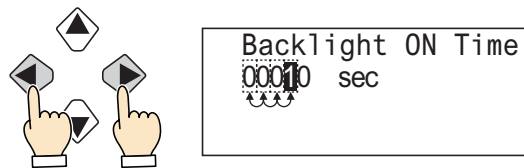

■ (ESC), (OK) buttons

Confirm menu items with the (OK) button. Return to the previous screen with the (ESC) button.

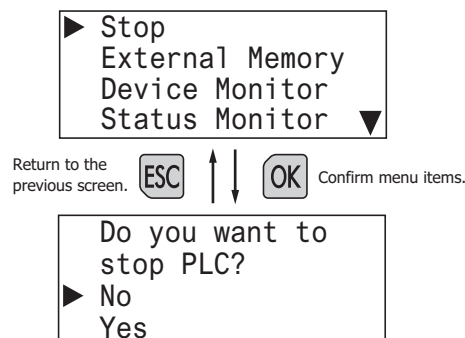

List of Button Operations on the System Menu Screen

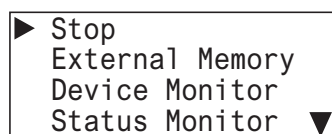

Switch	Press/Hold	Basic Operation
◀	Press	Moves the cursor up one line. If the cursor is at the start of the item list, nothing happens.
	Press and hold	Repeats the press operation.
▶	Press	Moves the cursor down one item. If the cursor is at the end of the item list, nothing happens.
	Press and hold	Repeats the press operation.
◀	Press	Nothing happens.
	Press and hold	
▶	Press	
	Press and hold	
OK	Press	Executes the function selected with the cursor (depending on the function, displays additional menus).
	Press and hold	Nothing happens.
ESC	Press	Returns to the previous screen (the calling screen).
	Press and hold	While pressing the ESC (ESC) button, press the OK (OK) button to return to the top screen of the system menu.

List of Button Operations after Executing a System Menu Item

System menu

(Backlight ON Time)

Menu language selection

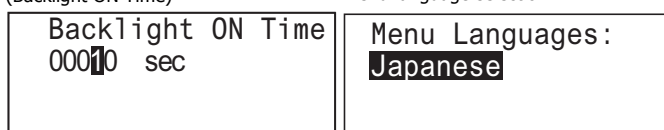

Switch	Press/Hold	Basic Operation
▲	Press	Adds 1 to the number selected with the cursor. Shows the item above the item selected with the cursor. If the top of the item list is displayed, nothing happens.
	Press and hold	Repeats the press operation.
▼	Press	Subtracts 1 from the number selected with the cursor. Shows the item below the item selected with the cursor. If the bottom of the item list is displayed, nothing happens.
	Press and hold	Repeats the press operation.
◀	Press	Moves the cursor once to the left.
	Press and hold	Repeats the press operation.
▶	Press	Moves the cursor once to the right.
	Press and hold	Repeats the press operation.
OK	Press	Confirms the modification.
	Press and hold	Nothing happens.
ESC	Press	Discards the modification.
	Press and hold	While pressing the ESC (ESC) button, press the OK (OK) button to discard the modification and return to the top screen of the system menu.

Switching to the System Menu

This section describes how to switch to the system menu from the standard screen.

1. On the standard screen, while pressing the **ESC** (ESC) button, press the **OK** (OK) button.
In further descriptions, this is explained as "**ESC** (ESC) + **OK** (OK) buttons". (1) and (2) in the diagram indicate the order to push the switches.

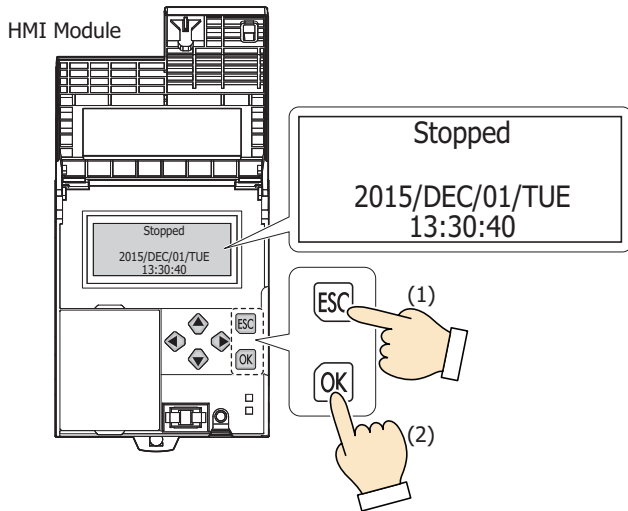

The system menu is displayed.

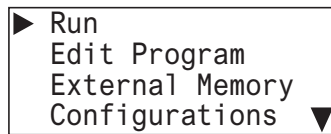

While the user program is running, the top screen for the running system menu is displayed.



On the system menu screen, press the **ESC** (ESC) + **OK** (OK) buttons to return to the standard screen.

Switching Run/Stop

This section describes how to run and stop the user program using the HMI module buttons.

Running the User Program

This section describes the steps to run the user program.

1. On the standard screen, press the  (ESC) +  (OK) buttons.

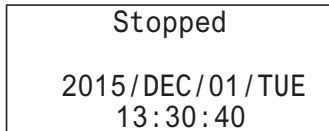

The system menu is displayed.

2. Select **Run** and press the  (OK) button.

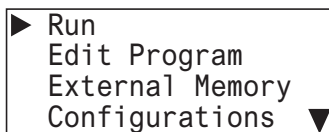

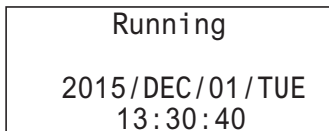

The user program is set to run.



Caution When setting the user program to run by using the buttons on the HMI module, fully ensure the safety before doing so.

Stopping the User Program

This section describes the steps to stop the user program.

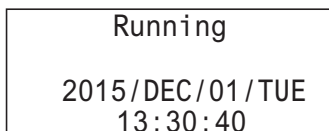

1. On the standard screen, press the  (ESC) +  (OK) buttons.

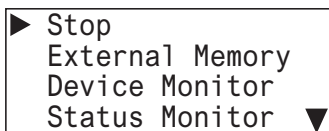

The system menu is displayed.

2. Select **Stop** and press the  (OK) button.



3. Select **Yes** with the  (down) button and press the  (OK) button.

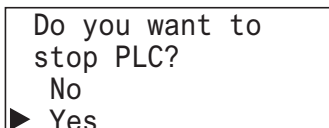

The user program is set to stop.

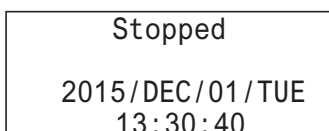

Editing Programs



This section describes how to reflect TP (timer preset values) and CP (counter preset values) in the user program and how to clear them.

Reflecting TP (Timer Preset Values) and CP (Counter Preset Values) in the User Program

Note: Even if you modify TP (timer preset values) and CP (counter preset values) using the function in "Monitoring Device Values" on page 7-32, those changes are not reflected in the user program at that time. To reflect the changed preset values in the user program, you must stop the user program and confirm the changes.

When you change TP (timer preset values) and CP (counter preset values) with the function in "Monitoring Device Values" on page 7-32 and attempt to leave device monitor mode, the following message is displayed.

Timer/counter preset values are changed.

1. Press the  (ESC) button or the  (OK) button to display the standard screen.

When the user program is running

Running
T/C is changed
2015/DEC/01/TUE
13:30:40



When the user program is stopped

Stopped
T/C is changed
2015/DEC/01/TUE
13:30:40

When TP (timer preset values) and CP (counter preset values) differ from the device values in the ROM, **T/C is changed** is displayed on the standard screen.

To reflect or clear preset value changes, stop the user program. For the steps to stop the user program, see "Switching Run/Stop" on page 7-9.

Stopped
T/C is changed
2015/DEC/01/TUE
13:30:40

2. On the standard screen, press the  (ESC) +  (OK) buttons to display the system menu.



▶ Run
Edit Program
External Memory
Configurations ▼

3. Select **Edit Program** with the  (up) and  (down) buttons and press the  (OK) button.

Run
▶ Edit Program
External Memory
Configurations ▼

4. Select **T/C Preset Values** and press the  (OK) button.



▶ T/C Preset Values

5. Select **Confirm** with the  (up) and  (down) buttons and press the  (OK) button.

T/C Change Status:
T/C is changed
Clear
▶ Confirm

The changed preset values are written to the user program in the ROM.

Clearing TP (Timer Preset Values) and CP (Counter Preset Values)

1. In step 5 of "Reflecting TP (Timer Preset Values) and CP (Counter Preset Values) in the User Program" on page 7-10, select **Clear** with the  (up) and  (down) buttons, and press the  (OK) button.

T/C Change Status: T/C is changed ▶ Clear Confirm
--

The changes made to the timer and counter preset values are deleted. The preset values of the user program in the ROM remain as they are before those values are modified. The device values return to the values before they are modified.

Note: The preset values can also be reflected to the user program in ROM using WindLDR. Select **Online > Monitor > Start Monitor**. Select **Online > PLC > Status** to display the PLC Status dialog box, and click the **Confirm** button under **TIM/CNT Change Status**. Once preset values are confirmed, they cannot be restored to their previous values, even if they are cleared.



FC6A Series MICROSmart Environment Settings

This section describes the operating procedures for environment settings such as the menu language, internal clock, slave number, and the scroll unit, speed, and blinking speed of messages displayed with the message (MSG) instruction.

These settings can be configured when the user program is stopped. These cannot be configured while the user program is running.

Changing the Menu Language

The menu language (English, Japanese, Chinese) can be changed. These settings can be configured when the user program is stopped. This cannot be changed while the user program is running.

1. On the standard screen, press the  (ESC) +  (OK) buttons.

English

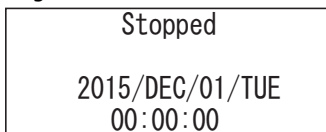



The system menu is displayed.

2. Select **Configurations** (When Japanese, 設定) with the  (up) and  (down) buttons and press the  (OK) button.

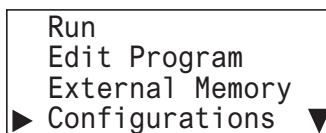

English

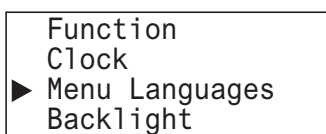

3. Select **Menu Languages** (When Japanese, メニュー言語) with the  (up) and  (down) buttons and press the  (OK) button.

English



4. Select **Japanese** (To switch from Japanese to English, 英語) with the  (down) button, and then press the  (OK) button to confirm.

English



- **Selectable menu languages**

The menu languages that can be selected are as follows.

English/Japanese/Chinese



Notes:

- The initial setting of the menu language is English.
- The initial setting of the menu language can be changed in the expansion modules configuration. For details, see "LCD Settings" on page 7-3.

Setting the LCD Backlight ON Time

When the HMI module operation buttons are pressed, the backlight turns on. After an operation button is pressed and the backlight turns on, the backlight automatically turns off if the operation buttons are not pressed for a certain amount of time. On the system menu, you can set the time from when the backlight turns on until it turns off. These cannot be configured while the user program is running.

These settings can be configured when the user program is stopped.

1. On the standard screen, press the  (ESC) +  (OK) buttons.

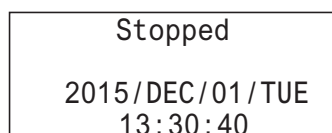

The system menu is displayed.

2. Select **Configurations** with the  (up) and  (down) buttons and press the  (OK) button.

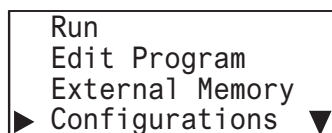

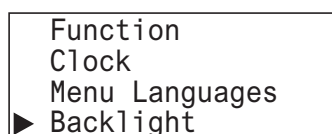

3. Select **Backlight** with the  (up) and  (down) buttons and press the  (OK) button.

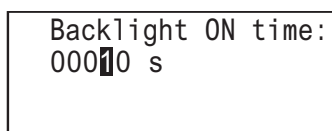

4. Move the cursor (digit) with the  (left) and  (right) buttons.



5. Select the value with the  (up) and  (down) buttons, and then press the  (OK) button to set the backlight ON time.



- **Backlight ON time configuration range**

The backlight ON time configuration range is as follows.

0 to 65,535 seconds

Notes:

- The default backlight ON time is 10 seconds. The default value can be changed in the expansion modules configuration. For details, see "LCD Settings" on page 7-3.
- The backlight ON time can be changed by modifying the value of D8067.
- When the backlight ON time is set from the system menu, the value of D8067 is modified.
- The value of D8067 returns to the default value when the battery backup dies.
- If the backlight ON time is 0, the backlight is always on.

Configuring the Slave Number

The slave number used in maintenance communication, Modbus RTU communication, and data link slave can be configured. These settings can be configured when the user program is stopped. This cannot be configured while the user program is running.

1. On the standard screen, press the **ESC** (ESC) + **OK** (OK) buttons.

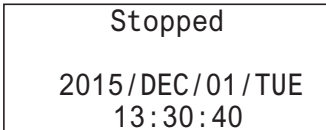

The system menu is displayed.

2. Select **Configurations** with the **▲** (up) and **▼** (down) buttons and press the **OK** (OK) button.

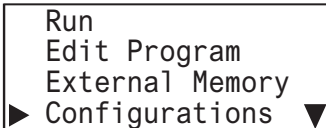

3. Select **Function** with the **▲** (up) and **▼** (down) buttons and press the **OK** (OK) button.

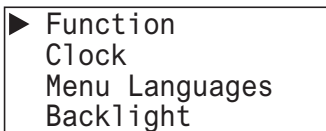

4. Select **Communications** with the **▲** (up) and **▼** (down) buttons and press the **OK** (OK) button.

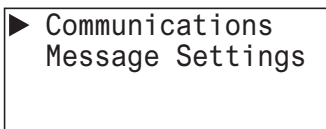

5. Select **Slave Number** with the **▲** (up) and **▼** (down) buttons and press the **OK** (OK) button.

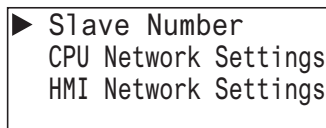

The port selection screen is displayed.

6. Select **Port 2** with the **▲** (up) and **▼** (down) buttons and press the **OK** (OK) button.
For example, change the slave number of the port 2 to **1**.

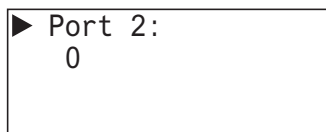

7. Specify **1** with the **▲** (up) and **▼** (down) buttons and press the **OK** (OK) button.

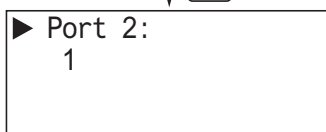
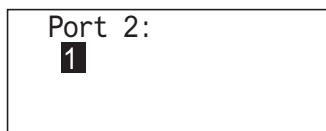



You can set the slave number of port 2 to 1.

• Selectable slave numbers

The slave numbers that can be selected are as follows. (Depending on the communication mode)

- Maintenance communication: 0 to 31
- Modbus RTU slave: 1 to 247
- Data link slave: 1 to 31

Notes:

- When the slave number is modified from the system menu, the value in the slave number type (constant/special data register) configured with WindLDR is modified. The slave number type cannot be changed from the system menu.
- If the slave number type configured with WindLDR is **Constant**, when the slave number is modified from the system menu and the  button is pressed, the modified slave number is reflected in the function area settings for the user program. If **Special Data Register**, the values of D8100, D8102 and D8103 are modified. (The modification is not reflected in the function area settings for the user program.)
- The values of D8100, D8102 and D8103 return to the default values when the battery backup dies.
- The slave number range differs according to the communication mode (maintenance communication/Modbus RTU slave/data link slave). If a value outside the configuration range is set, the following message is displayed. Press the  (ESC) button or the  button to return to the configuration screen, and then set the correct slave number again.



```
Port 2:
Out of valid range
0
```

- For maintenance communication, see Chapter 4 "Maintenance Communication via Port 1" in the "FC6A Series MICROSmart Communication Manual". For Modbus RTU slave/Modbus TCP slave, see Chapter 6 "Modbus RTU Communication via RS232C/RS485" in the "FC6A Series MICROSmart Communication Manual".

Configuring the Network Settings

The CPU module and HMI module network settings can be configured. These settings are configured when the user program is stopped. These cannot be configured while the user program is running.

Changing the CPU module network settings**■ Changing the setting**

1. On the standard screen, press the  (ESC) +  (OK) buttons.

```
Stopped
2015/DEC/01/TUE
13:30:40
```



The system menu is displayed.

2. Select **Configurations** with the  (up) and  (down) buttons and press the  (OK) button.



```
Run
Edit Program
External Memory
▶ Configurations ▼
```

3. Select **Function** with the  (up) and  (down) buttons and press the  (OK) button.

```
▶ Function
Clock
Menu Languages
Backlight
```

4. Select **Communications** with the  (up) and  (down) buttons and press the  (OK) button.

```
▶ Communications
Message Settings
```



5. Select **CPU Network Settings** with the  (up) and  (down) buttons and press the  (OK) button.

```
Slave Number
▶ CPU Network Settings
HMI Network Settings
```

The CPU network settings screen is displayed.



7: HMI FUNCTION

Note: When the Plus CPU module is used, **CPU Network 2 Settings** is displayed.



Select **CPU Network 2 Settings** with the  (up) and  (down) buttons and press the  (OK) button.

```
Slave Number
CPU Network Settings
▶ CPU Network 2 Settings
HMI Network Settings
```

The following operations are the same with **CPU Network Settings**.

6. Select **Setting** with the  (up) and  (down) buttons and press the  (OK) button.

```
CPU Network Settings
▶ Setting: Fixed
IP Address
192.168. 1. 5 ▼
```

7. With the  (up) and  (down) buttons, select **ON** or **OFF**.

```
Setting:
Fixed
Data Register:
DHCP
```

Notes:



- If you specify **Data Register**, the network settings cannot be configured because they are acquired from the data registers.
- The current network settings can be checked from the status monitor.

8. Press the  (OK) button to change the CPU module's DHCP setting and to display the CPU Network Settings 1 screen.

```
CPU Network Settings
▶ Setting: Fixed
IP Address
192.168. 1. 5 ▼
```



Next, to change the IP address, subnet mask, gateway, preferred DNS server, and alternate DNS server, see the following pages.

- "Changing the IP address" on page 7-17, from step **2**
- "Changing the subnet mask" on page 7-18, from step **2**
- "Changing the gateway" on page 7-25, from step **2**
- "Changing the preferred DNS server" on page 7-20, from step **2**
- "Changing the alternate DNS server" on page 7-21, from step **2**

9. Press the  (ESC) button to display the screen in the following diagram. Select **Yes** with the  (down) button and press the  (OK) button.





```
Do you want to
configure network?
No
▶ Yes
```

■ Changing the IP address

1. Display the CPU Network Settings screen with the same procedure as steps 1 through 5 in "Changing the setting" on page 7-15.
2. Select **IP Address** with the  (up) and  (down) buttons and press the  (OK) button.

```
CPU Network Settings
Setting: Fixed
▶ IP Address
  192.168. 1. 5 ▼
```

The range is 000.000.000.000 to 255.255.255.255.
For example, change the IP address to 192.168.1.6.

3. Move the cursor with the  (left) and  (right) buttons and modify the value with the  (up) and  (down) buttons.



```
IP Address:
192.168. 1. 6
```

4. Press the  (OK) button to change the CPU module's IP address to 192.168.1.6 and to display the CPU Network Settings screen.

```
CPU Network Settings
Setting: Fixed
▶ IP Address
  192.168. 1. 6 ▼
```

Next, to change the setting, subnet mask, gateway, preferred DNS server, and alternate DNS server, see the following pages.

- "Changing the setting" on page 7-15, from step 6
- "Changing the subnet mask" on page 7-18, from step 2
- "Changing the gateway" on page 7-19, from step 2
- "Changing the preferred DNS server" on page 7-20, from step 2
- "Changing the alternate DNS server" on page 7-21, from step 2

5. Press the  (ESC) button to display the screen in the following diagram.
Select Yes with the  (down) button and press the  (OK) button.

```
Do you want to
configure network?
No
▶ Yes
```

7: HMI FUNCTION

■ Changing the subnet mask

1. Display the CPU Network Settings screen with the same procedure as steps 1 through 5 in "Changing the setting" on page 7-15.

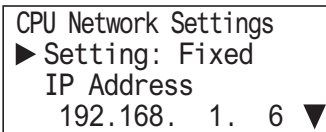

2. Select **Subnet Mask** with the ◀ (up) and ▶ (down) buttons and press the [OK] (OK) button.

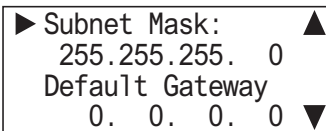

The range is 000.000.000.000 to 255.255.255.255.

For example, change the subnet mask to 255.255.254.0.

3. Move the cursor with the ◀ (left) and ▶ (right) buttons and modify the value with the ▲ (up) and ▼ (down) buttons.

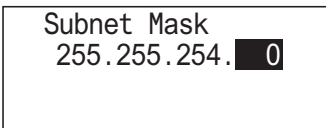

4. Press the [OK] (OK) button to change the CPU module's subnet mask to 255.255.254.0 and to display the following screen.

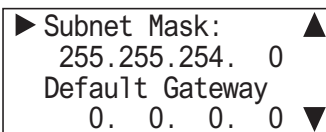

Next, to change the setting, IP address, gateway, preferred DNS server, and alternate DNS server, see the following pages.

- "Changing the setting" on page 7-15, from step 6
 - "Changing the subnet mask" on page 7-18, from step 2
 - "Changing the gateway" on page 7-25, from step 2
 - "Changing the preferred DNS server" on page 7-20, from step 2
 - "Changing the alternate DNS server" on page 7-21, from step 2
5. Press the [ESC] (ESC) button to display the screen in the following diagram.
Select **Yes** with the ▼ (down) button and press the [OK] (OK) button.

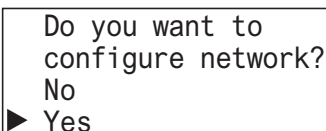



■ Changing the gateway

1. Display the CPU Network Settings screen with the same procedure as steps 1 through 5 in "Changing the setting" on page 7-15.

```

CPU Network Settings
▶ Setting: Fixed
  IP Address
  192.168. 1. 6 ▼
  
```





2. Select **Default Gateway** with the  (up) and  (down) buttons and press the  (OK) button.

```

Subnet Mask ▲
  255.255.254.0
▶ Default Gateway:
  0. 0. 0. 0 ▼
  
```

The range is 000.000.000.000 to 255.255.255.255.

For example, change the default gateway to 192.168.1.3.

3. Move the cursor with the  (left) and  (right) buttons and modify the value with the  (up) and  (down) buttons.

```

Default Gateway
  192.168. 1. 3
  
```



4. Press the  (OK) button to change the CPU module's default gateway to 192.168.1.3 and to display the following screen.

```

Subnet Mask ▲
  255.255.254.0
▶ Default Gateway:
  192.168. 1. 3
  
```

Next, to change the setting, IP address, subnet mask, preferred DNS server, and alternate DNS server, see the following pages.

- "Changing the setting" on page 7-15, from step 6
- "Changing the IP address" on page 7-23, from step 2
- "Changing the subnet mask" on page 7-18, from step 2
- "Changing the preferred DNS server" on page 7-20, from step 2
- "Changing the alternate DNS server" on page 7-21, from step 2

5. Press the  (ESC) button to display the screen in the following diagram. Select **Yes** with the  (down) button and press the  (OK) button.

```



Do you want to
configure network?
No
▶ Yes
  
```

7: HMI FUNCTION

■ Changing the preferred DNS server

1. Display the CPU Network Settings screen with the same procedure as steps **1** through **5** in "Changing the setting" on page 7-15.





```
CPU Network Settings
▶ Setting: Fixed
  IP Address
  192.168. 1. 6 ▼
```

2. Select **Preferred DNS Server** with the  (up) and  (down) buttons and press the  (OK) button.

```
▶ Preferred DNS Server: ▲
  0. 0. 0. 0
  Alternate DNS Server:
  0. 0. 0. 0 ▼
```

The range is 000.000.000.000 to 255.255.255.255.

For example, change the preferred DNS server to 192.168.1.200.



3. Move the cursor with the  (left) and  (right) buttons and modify the value with the  (up) and  (down) buttons.

```
Preferred DNS Server:
  192.168. 1. 200
```

4. Press the  (OK) button to change the CPU module's preferred DNS server to 192.168.1.200 and to display the following screen.

```
▶ Preferred DNS Server: ▲
  192.168. 1.200
  Alternate DNS Server:
  0. 0. 0. 0 ▼
```

Next, to change the setting, IP address, subnet mask, gateway, and alternate DNS server, see the following pages.



- "Changing the setting" on page 7-15, from step **6**
 - "Changing the IP address" on page 7-23, from step **2**
 - "Changing the subnet mask" on page 7-18, from step **2**
 - "Changing the preferred DNS server" on page 7-20, from step **2**
 - "Changing the alternate DNS server" on page 7-21, from step **2**
5. Press the  (ESC) button to display the screen in the following diagram.
Select **Yes** with the  (down) button and press the  (OK) button.

```
Do you want to
configure network?
No
▶ Yes
```

■ Changing the alternate DNS server

1. Display the CPU Network Settings screen with the same procedure as steps **1** through **5** in "Changing the setting" on page 7-15.





```
CPU Network Settings
▶ Setting: Fixed
  IP Address
  192.168. 1. 6 ▼
```

2. Select **Alternate DNS Server** with the  (up) and  (down) buttons and press the  (OK) button.

```
Preferred DNS Server:▲
  192.168. 1.200
▶ Alternate DNS Server:
  0. 0. 0. 0 ▼
```

The range is 000.000.000.000 to 255.255.255.255.

For example, change the alternate DNS server to 192.168.1.201.



3. Move the cursor with the  (left) and  (right) buttons and modify the value with the  (up) and  (down) buttons.

```
Alternate DNS Server:
  192.168. 1.201
```

4. Press the  (OK) button to change the CPU module's alternate DNS server to 192.168.1.201 and to display the following screen.

```
Preferred DNS Server:▲
  192.168. 1.200
▶ Alternate DNS Server:
  192.168. 1.201 ▼
```



Next, to change the setting, IP address, subnet mask, gateway, and preferred DNS server, see the following pages.

- "Changing the setting" on page 7-15, from step **6**
 - "Changing the IP address" on page 7-17, from step **2**
 - "Changing the subnet mask" on page 7-18, from step **2**
 - "Changing the gateway" on page 7-19, from step **2**
 - "Changing the preferred DNS server" on page 7-20, from step **2**
5. Press the  (ESC) button to display the screen in the following diagram. Select **Yes** with the  (down) button and press the  (OK) button.

```
Do you want to
configure network?
No
▶ Yes
```

Changing the HMI module network settings

■ Changing the setting

1. On the standard screen, press the  (ESC) +  (OK) buttons.





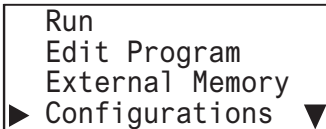

The system menu is displayed.

2. Select **Configurations** with the  (up) and  (down) buttons and press the  (OK) button.

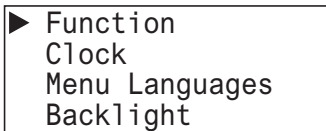



3. Select **Function** with the  (up) and  (down) buttons and press the  (OK) button.



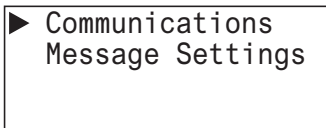

4. Select **Communications** with the  (up) and  (down) buttons and press the  (OK) button.



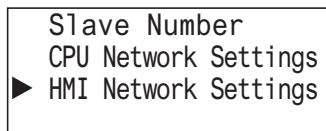

5. Select **HMI Network Settings** with the  (up) and  (down) buttons and press the  (OK) button.

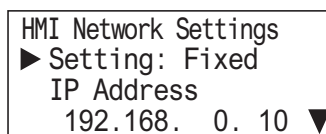

6. Select **Setting** with the  (up) and  (down) buttons and press the  (OK) button.



7. With the  (up) and  (down) buttons, select **ON** or **OFF**.



Notes:



- If you specify **Data Register**, the network settings cannot be configured because they are acquired from the data registers.
- The current network settings can be checked from the status monitor.

8. Press the  (OK) button to change the HMI module's **Setting** and to display the HMI Network Settings 1 screen.

```
HMI Network Settings ▲
Setting: Fixed
▶ IP Address
  192.168.  1. 10 ▼
```

Next, to change the IP address, subnet mask, gateway, preferred DNS server, and alternate DNS server, see the following pages.

- "Changing the IP address" on page 7-23, from step 2
- "Changing the subnet mask" on page 7-24, from step 2
- "Changing the gateway" on page 7-25, from step 2
- "Changing the preferred DNS server" on page 7-26, from step 2
- "Changing the alternate DNS server" on page 7-27, from step 2

9. Press the  (ESC) button to display the screen in the following diagram. Select **Yes** with the  (down) button and press the  (OK) button.

```
Do you want to
configure network?
No
▶ Yes
```

■ Changing the IP address

1. Display the HMI Network Settings screen with the same procedure as steps 1 through 5 in "Changing the setting" on page 7-22.





```
HMI Network Settings
▶ Setting: Fixed
  IP Address
    192.168.  1. 10 ▼
```

2. Select **IP Address** on HMI Network Settings with the the  (up) and  (down) buttons and press the  (OK) button.

```
HMI Network Settings ▲
Setting: Fixed
▶ IP Address
  192.168.  1. 10 ▼
```

The range is 000.000.000.000 to 255.255.255.255.

For example, change the IP address to 192.168.11.6.

3. Move the cursor with the  (left) and  (right) buttons and modify the value with the  (up) and  (down) buttons.

```
IP Address
192.168. 11. 6
```

4. Press the  (OK) button to change the HMI module's IP address to 192.168.11.6 and to display the following screen.

```
HMI Network Settings ▲
Setting: Fixed
▶ IP Address
  192.168. 11.  6 ▼
```

Next, to change the setting, subnet mask, gateway, preferred DNS server, and alternate DNS server, see the following pages.

- "Changing the setting" on page 7-22, from step 5
- "Changing the subnet mask" on page 7-24, from step 2
- "Changing the gateway" on page 7-25, from step 2
- "Changing the preferred DNS server" on page 7-26, from step 2
- "Changing the alternate DNS server" on page 7-27, from step 2

5. Press the  (ESC) button to display the screen in the following diagram. Select **Yes** with the  (down) button and press the  (OK) button.

```
Do you want to
configure network?
No
▶ Yes
```

7: HMI FUNCTION

■ Changing the subnet mask

1. Display the HMI Network Settings screen with the same procedure as steps **1** through **5** in "Changing the setting" on page 7-22.



2. Select **Subnet Mask** with the ◀ (up) and ▶ (down) buttons and press the [OK] (OK) button.

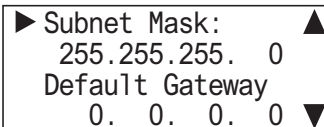

The range is 000.000.000.000 to 255.255.255.255.

For example, change the subnet mask to 255.255.254.0.

3. Move the cursor with the ◀ (left) and ▶ (right) buttons and modify the value with the ▲ (up) and ▼ (down) buttons.

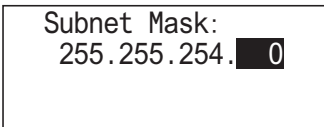

4. Press the [OK] (OK) button to change the HMI module's subnet mask to 255.255.254.0 and to display the following screen.

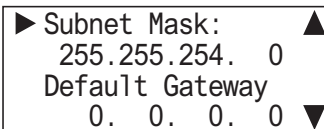

Next, to change the setting, IP address, gateway, preferred DNS server, and alternate DNS server, see the following pages.

- "Changing the setting" on page 7-22, from step **5**
 - "Changing the IP address" on page 7-23, from step **2**
 - "Changing the gateway" on page 7-25, from step **2**
 - "Changing the preferred DNS server" on page 7-26, from step **2**
 - "Changing the alternate DNS server" on page 7-27, from step **2**
5. Press the [ESC] (ESC) button to display the screen in the following diagram.
Select **Yes** with the ▼ (down) button and press the [OK] (OK) button.

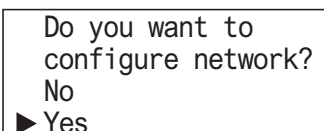



■ Changing the gateway

1. Display the HMI Network Settings screen with the same procedure as steps 1 through 5 in "Changing the setting" on page 7-22.

```

HMI Network Settings
▶ Setting: Fixed
  IP Address
    192.168. 11. 6 ▼
  
```





2. Select **Default Gateway** with the  (up) and  (down) buttons and press the  (OK) button.

```

Subnet Mask: ▲
  255.255.254. 0
▶ Default Gateway ▼
  0. 0. 0. 0 ▼
  
```

The range is 000.000.000.000 to 255.255.255.255.

For example, change the gateway to 192.168.11.3.

3. Move the cursor with the  (left) and  (right) buttons and modify the value with the  (up) and  (down) buttons.

```

Default Gateway
  192.168. 11. 3
  
```



4. Press the  (OK) button to change the HMI module's gateway to 192.168.11.3 and to display the following screen.

```

Subnet Mask: ▲
  255.255.254. 0
▶ Default Gateway: ▼
  192.168. 11. 3 ▼
  
```

Next, to change the setting, IP address, subnet mask, preferred DNS server, and alternate DNS server, see the following pages.

- "Changing the setting" on page 7-22
- "Changing the IP address" on page 7-23
- "Changing the subnet mask" on page 7-24
- "Changing the preferred DNS server" on page 7-26, from step 2
- "Changing the alternate DNS server" on page 7-27, from step 2

5. Press the  (ESC) button to display the screen in the following diagram. Select **Yes** with the  (down) button and press the  (OK) button.

```



Do you want to
configure network?
No
▶ Yes
  
```

7: HMI FUNCTION

■ Changing the preferred DNS server





1. Display the HMI Network Settings screen with the same procedure as steps **1** through **5** in "Changing the setting" on page 7-22.

```
HMI Network Settings
▶ Setting: Fixed
  IP Address
  192.168. 11. 6 ▼
```

2. Select **Preferred DNS Server** with the  (up) and  (down) buttons and press the  (OK) button.

```
▶ Preferred DNS Server: ▲
  0. 0. 0. 0
  Alternate DNS Server:
  0. 0. 0. 0 ▼
```

The range is 000.000.000.000 to 255.255.255.255.
For example, change the preferred DNS server to 192.168.11.200.



3. Move the cursor with the  (left) and  (right) buttons and modify the value with the  (up) and  (down) buttons.

```
Preferred DNS Server:
  192.168. 11. 200
```

4. Press the  (OK) button to change the HMI module's preferred DNS server to 192.168.11.200 and to display the following screen.

```
▶ Preferred DNS Server: ▲
  192.168. 11.200
  Alternate DNS Server:
  0. 0. 0. 0 ▼
```

Next, to change the setting, IP address, subnet mask, gateway, and alternate DNS server, see the following pages.



- "Changing the setting" on page 7-22, from step **6**
 - "Changing the IP address" on page 7-23, from step **2**
 - "Changing the subnet mask" on page 7-24, from step **2**
 - "Changing the preferred DNS server" on page 7-26, from step **2**
 - "Changing the alternate DNS server" on page 7-27, from step **2**
5. Press the  (ESC) button to display the screen in the following diagram.
Select **Yes** with the  (down) button and press the  (OK) button.

```
Do you want to
configure network?
No
▶ Yes
```

■ Changing the alternate DNS server

1. Display the HMI Network Settings screen with the same procedure as steps **1** through **5** in "Changing the setting" on page 7-22.





```
HMI Network Settings
▶ Setting: Fixed
  IP Address
  192.168. 11. 6 ▼
```

2. Select **Alternate DNS Server** with the  (up) and  (down) buttons and press the  (OK) button.

```
Preferred DNS Server:▲
  192.168. 11.200
▶ Alternate DNS Server:
  0. 0. 0. 0 ▼
```

The range is 000.000.000.000 to 255.255.255.255.

For example, change the alternate DNS server to 192.168.11.201.



3. Move the cursor with the  (left) and  (right) buttons and modify the value with the  (up) and  (down) buttons.

```
Alternate DNS Server:
  192.168. 11.201
```

4. Press the  (OK) button to change the HMI module's alternate DNS server to 192.168.11.201 and to display the following screen.

```
Preferred DNS Server:▲
  192.168. 11.200
▶ Alternate DNS Server:
  192.168. 11.201 ▼
```

Next, to change the setting, IP address, subnet mask, gateway, and preferred DNS server, see the following pages.

- "Changing the setting" on page 7-22, from step **6**
 - "Changing the IP address" on page 7-23, from step **2**
 - "Changing the subnet mask" on page 7-24, from step **2**
 - "Changing the gateway" on page 7-25, from step **2**
 - "Changing the preferred DNS server" on page 7-26, from step **2**
5. Press the  (ESC) button to display the screen in the following diagram. Select **Yes** with the  (down) button and press the  (OK) button.



```
Do you want to
configure network?
No
▶ Yes
```

Changing the Message Display Settings

Modifying the Scroll Speed

The scroll speed for messages displayed with the message (MSG) instruction can be configured.

These settings can be configured when the user program is stopped. This cannot be configured while the user program is running.

1. On the standard screen, press the  (ESC) +  (OK) buttons.

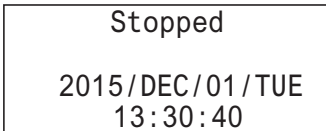



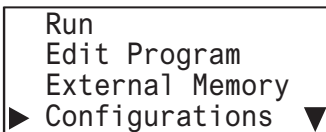

The system menu is displayed.

2. Select **Configurations** with the  (up) and  (down) buttons and press the  (OK) button.

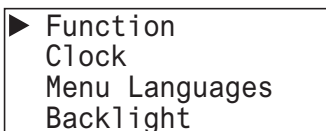

3. Select **Function** with the  (up) and  (down) buttons and press the  (OK) button.



4. Select **Message Settings** with the  (up) and  (down) buttons and press the  (OK) button.

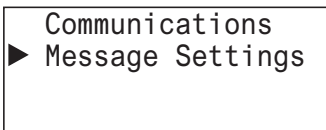

5. Select **Scroll Settings** with the  (up) and  (down) buttons and press the  (OK) button.

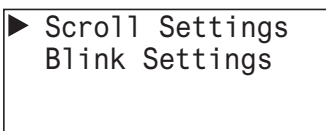

6. Select **Scroll Speed** with the  (up) and  (down) buttons and press the  (OK) button.

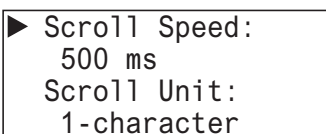

7. Modify the value with the  (up) and  (down) buttons and press the  (OK) button.

For example, change the value to 700 ms.

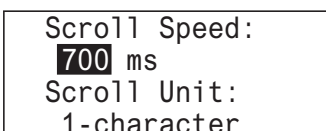

- **Selectable scroll speeds**



The scroll speeds that can be selected are as follows.

500/600/700/800/900/1000 ms

Configuring the Scroll Unit

The scroll unit for messages displayed with the message (MSG) instruction can be configured.

These settings can be configured when the user program is stopped. This cannot be configured while the user program is running.

1. On the standard screen, press the  (ESC) +  (OK) buttons.





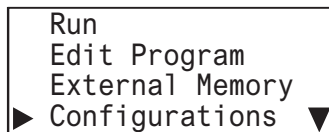

The system menu is displayed.

2. Select **Configurations** with the  (up) and  (down) buttons and press the  (OK) button.

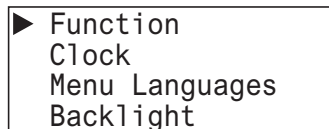

3. Select **Function** with the  (up) and  (down) buttons and press the  (OK) button.



4. Select **Message Settings** with the  (up) and  (down) buttons and press the  (OK) button.



5. Select **Scroll Settings** with the  (up) and  (down) buttons and press the  (OK) button.

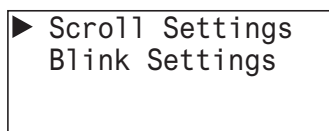

6. Select **Scroll Unit** with the  (up) and  (down) buttons and press the  (OK) button.

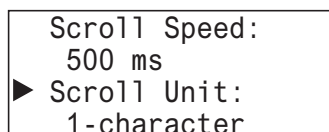

7. Modify the scroll unit with the  (up) and  (down) buttons and press the  (OK) button.

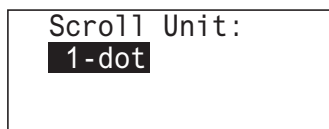

- **Selectable scroll units**

The scroll units that can be selected are as follows.



1 character/1-dot

7: HMI FUNCTION

Configuring the Blinking Speed

The blinking speed for messages displayed with the message (MSG) instruction can be configured.

These settings can be configured when the user program is stopped. This cannot be configured while the user program is running.

1. On the standard screen, press the  (ESC) +  (OK) buttons.

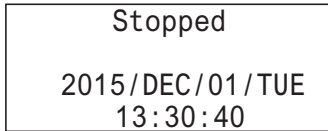



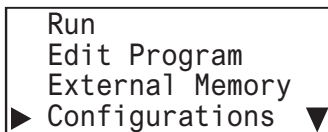

The system menu is displayed.

2. Select **Configurations** with the  (up) and  (down) buttons and press the  (OK) button.

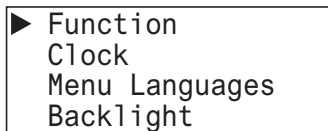

3. Select **Function** with the  (up) and  (down) buttons and press the  (OK) button.



4. Select **Message Settings** with the  (up) and  (down) buttons and press the  (OK) button.

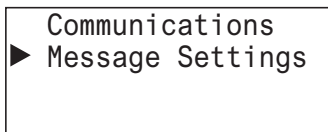

5. Select **Blink Settings** with the  (up) and  (down) buttons and press the  (OK) button.

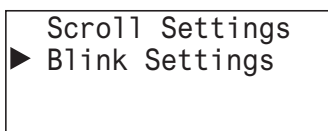

6. Select **Blinking Speed** with the  (up) and  (down) buttons and press the  (OK) button.

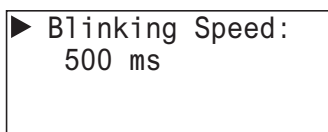

7. Modify the value with the  (up) and  (down) buttons and press the  (OK) button. For example, change the value to 1,000 ms.

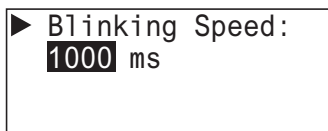

- **Selectable blinking speeds**

The blinking speeds that can be selected are as follows.

500/600/700/800/900/1000 ms

Setting the Calendar/Clock

This section describes how to adjust the internal clock in the CPU module.

These settings can be configured when the user program is stopped. This cannot be adjusted while the user program is running.

1. On the standard screen, press the **ESC** (ESC) + **OK** (OK) buttons.

```

Stopped
2015/DEC/01/TUE
13:30:40
  
```

The system menu is displayed.

2. Select **Configurations** with the **▲** (up) and **▼** (down) buttons and press the **OK** (OK) button.

```

Run
Edit Program
External Memory
▶ Configurations ▼
  
```

3. Select **Clock** with the **▲** (up) and **▼** (down) buttons and press the **OK** (OK) button.

```

Function
▶ Clock
Menu Languages
Backlight
  
```

4. Move the cursor (year⇄month⇄day⇄hour⇄minute⇄second) with the **◀** (left) and **▶** (right) buttons and modify the value with the **▲** (up) and **▼** (down) buttons.

For example, modify **Day**. Move the cursor to **Day** with the **◀** (left) and **▶** (right) buttons.

```

2015/12/01
13:30:40
  
```

5. Modify **Day** with the **▲** (up) and **▼** (down) buttons.

```

2015/12/04
13:30:40
  
```

6. From **Day** position, press the **▶** (right) button to next move to the (hour:minute:second) row. For example, modify **Minute**. Move the cursor to **Minute** with the **◀** (left) and **▶** (right) buttons.

```

2015/12/04
13:30:40
  
```

7. Modify **Minute** with the **▲** (up) and **▼** (down) buttons.

```

2015/12/04
13:35:40
  
```

8. Press the **OK** (OK) button to confirm the modifications to the calendar/clock.

- **Calendar/clock configuration range**

The calendar/clock configuration range is as follows.

Year	Month	Day	Hour	Minute	Second
2000 to 2099	01 to 12	01 to 31	00 to 23	00 to 59	00 to 59

Notes:

- When the date is modified, the day of the week automatically changes. The day of the week is not displayed on the configuration screen.
- If an invalid date is set, an error message is displayed. When the error message is displayed, press the **ESC** (ESC) button or the **OK** (OK) button to return to the configuration screen, and then set a valid date.

Monitoring the FC6A Series MICROSmart

Monitoring Device Values

You can check device values on the FC6A Series MICROSmart. The HMI module features two types of device monitors.

Going to device monitor mode from the standard screen

Device values can be checked but not modified.

Running **Device Monitor** on the system menu

Device values can be checked and modified.

Device values can be monitored regardless of the user program operating status (run/stop). This section describes the device monitor mode when the user program is running.

1. If you press the ◀ (left) and ▶ (right) buttons on the standard screen, the FC6A Series MICROSmart switches to the device monitor mode and the device values can be monitored (Device values cannot be modified). Continue to press the ◀ (left) and ▶ (right) buttons to change the device type.

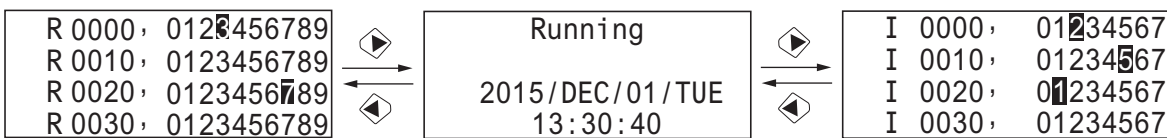

The device type changes in the order below.

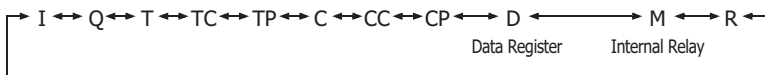

I, Q, T, C, M, and R are bit devices.

TC, TP, CC, CP, and D are word devices.

Note: I1000 or greater, Q1000 or greater, and non-retentive data registers are not displayed in the Device Monitor.

2. Press the ▲ (up) and ▼ (down) buttons to change the device number.

I 0000	,	01234567
I 0010	,	01234567
I 0020	,	01234567
I 0030	,	012345

Shows the on/off state of the inputs (I).

Inverted inputs are on state.

↓ ▼

I 0010	,	01234567
I 0020	,	01234567
I 0030	,	012345
I 0040	,	01234567

Modifying Device Values

This section describes how to specify a device and modify that device value.

Modifying a Bit Device Value

This section describes an example of switching on M0012 while the user program is running.

1. On the standard screen, press the (ESC) + (OK) buttons.

```
Running
2015/DEC/01/TUE
13:30:40
```

The system menu is displayed.

2. Select **Device Monitor** with the (up) and (down) buttons and press the (OK) button.
The FC6A Series MICROSmart switches to the Device Monitor mode.

```
Stop
External Memory
▶ Device Monitor
Status Monitor ▼
```

3. Select device type: M (internal relay) with the (left) and (right) buttons and press and hold the (OK) button.
0 flashes to indicate the focus is on M0000.

```
▶ M00000, 01234567
M00010, 01234567
M00020, 01234567
M00030, 012345
```

4. With the (up) and (down) buttons, select M0010.
0 flashes to indicate the focus is on M0010.

```
M00000, 01234567
▶ M00010, 01234567
M00020, 01234567
M00030, 012345
```

5. Move the cursor to **2** with the (right) button and press the (OK) button.



```
M00000, 01234567
▶ M00010, 01234567
M00020, 01234567
M00030, 012345
```

M0012 turns on.

7: HMI FUNCTION

Modifying a Word Device Value

This section describes an example of changing D0002 to 500 while the user program is running.



1. On the standard screen, press the  (ESC) +  (OK) buttons.

```
Running
2015/DEC/01/TUE
13:30:40
```



The system menu is displayed.

2. Select **Device Monitor** with the  (up) and  (down) buttons and press the  (OK) button.
The FC6A Series MICROSmart switches to the Device Monitor mode.



```
Stop
External Memory
▶ Device Monitor
Status Monitor ▼
```

3. Select device type: D (Data Register) with the  (left) and  (right) buttons and press and hold the  (OK) button.

```
▶ D00000: 0
D00001: 0
D00002: 0
D00003: 0
```

4. Select D0002 with the  (up) and  (down) buttons and press the  (OK) button.

```
D00000: 0
D00001: 0
▶ D00002: 0
D00003: 0
```

5. Move the digit with the  (right) button and modify the value with the  (up) and  (down) buttons.

```
Change Device Val.:
D 00002:00500
DEC (W)
```

6. Press the  (OK) button to confirm.

```
D00000: 0
D00001: 0
▶ D00002: 500
D00003: 0
```

Monitoring the FC6A Series MICROSmart Status

You can check the FC6A Series MICROSmart system software version, scan time, protection status, CPU network settings, and HMI network settings.

1. On the standard screen, press the **ESC** (ESC) + **OK** (OK) buttons.

When the user program is running

```
Running
2015/DEC/01/TUE
13:30:40
```

When the user program is stopped

```
Stopped
2015/DEC/01/TUE
13:30:40
```

The system menu is displayed.

2. Select **Status Monitor** with the **▲** (up) and **▼** (down) buttons and press the **OK** (OK) button.

When the user program is running

```
Stop
External Memory
Device Monitor
▶ Status Monitor ▼
```

When the user program is stopped

```
External Memory ▲
Configurations
Device Monitor
▶ Status Monitor ▼
```

3. The system version is displayed. Press the **▼** (down) button.

When the user program is running

```
System Version:
1.00
Run/Stop Status:
Running ▼
```

When the user program is stopped

```
System Version:
1.00
Run/Stop Status:
Stopped ▼
```

4. The scan time is displayed. Press the **▼** (down) button.

```
Scan Time: ▲
Current: 2 ms
Maximum: 4 ms
Minimum: 2 ms ▼
```

5. The upload protection status is displayed. Press the **▼** (down) button.

```
Protection Status: ▲
Read Program:
None ▼
```

6. The download protection status is displayed. Press the **▼** (down) button.

```
Write Program: ▲
None ▼
```

7. CPU Network Settings 1 is displayed. Press the **▼** (down) button.

```
CPU Network Settings ▲
Setting: Fixed
IP Address
192.168. 1. 6 ▼
```

8. CPU Network Settings 2 is displayed. Press the **▼** (down) button.

```
CPU Network Settings 2 ▲
Subnet Mask:
255.255.254. 0 ▼
```

7: HMI FUNCTION

9. CPU Network Settings 3 is displayed. Press the  (down) button.

```
CPU Network Settings 3 ▲  
Default Gateway:  
192.168. 1. 3 ▼
```

10. CPU Network Settings 4 is displayed. Press the  (down) button.

```
CPU Network Settings 4 ▲  
Preferred DNS Server:  
192.168. 1.200 ▼
```

11. CPU Network Settings 5 is displayed. Press the  (down) button.

```
CPU Network Settings 5 ▲  
Alternate DNS Server:  
192.168. 1.201 ▼
```

12. CPU Network Settings 6 is displayed. Press the  (down) button.

```
CPU Network Settings 6 ▲  
MAC Address:  
FF-FF-FF-FF-FF-FF ▼
```

When the connected PLC is All-in-One CPU module or CAN J1939 All-in-One CPU module, the screen goes to the step 19.

13. CPU Network Settings 7 is displayed. Press the  (down) button.

```
CPU Network Settings 7 ▲  
Setting: Fixed  
IP Address  
192.168. 2. 6 ▼
```

14. CPU Network Settings 8 is displayed. Press the  (down) button.

```
CPU Network Settings 8 ▲  
Subnet Mask:  
255.255.254. 0 ▼
```

15. CPU Network Settings 9 is displayed. Press the  (down) button.

```
CPU Network Settings 9 ▲  
Default Gateway:  
192.168. 2. 3 ▼
```

16. CPU Network Settings 10 is displayed. Press the  (down) button.

```
CPU Network Settings 10 ▲  
Preferred DNS Server:  
192.168. 2.200 ▼
```

17. CPU Network Settings 11 is displayed. Press the  (down) button.

```
CPU Network Settings 11 ▲  
Alternate DNS Server:  
192.168. 2.201 ▼
```

18. CPU Network Settings 12 is displayed. Press the ◀ (down) button.

```
CPU Network Settings 12 ▲  
MAC Address:  
FF-FF-FF-FF-FF-FF ▼
```

19. HMI Network Settings 1 is displayed. Press the ◀ (down) button.

```
HMI Network Settings 1 ▲  
Setting: Fixed  
IP Address  
192.168. 11. 6 ▼
```

20. HMI Network Settings 2 is displayed. Press the ◀ (down) button.

```
HMI Network Settings 2 ▲  
Subnet Mask:  
255.255.254. 0 ▼
```

21. HMI Network Settings 3 is displayed. Press the ◀ (down) button.

```
HMI Network Settings 3 ▲  
Default Gateway  
192.168. 11. 3 ▼
```

22. HMI Network Settings 4 is displayed. Press the ◀ (down) button.

```
HMI Network Settings 4 ▲  
Preferred DNS Server:  
192.168. 11.200 ▼
```

23. HMI Network Settings 5 is displayed. Press the ◀ (down) button.

```
HMI Network Settings 5 ▲  
Alternate DNS Server:  
192.168. 11.201 ▼
```

24. HMI Network Settings 6 is displayed. Press the ◀ (down) button.

```
HMI Network Settings 6 ▲  
MAC Address:  
FF-FF-FF-FF-FF-FF ▼
```

Checking/Clearing Error Information

This section describes how to check error details and how to clear the error when an error occurs while the user program is running and an error message is displayed on the LCD.

Checking the Error Details and Clearing the Error

1. When an error occurs, the following message is displayed.

When an error occurs while user program is running and the user program stops

```
Error!  
PLC is stopped.  
Press OK button for  
more details.
```



When an error occurs while user program is running and the user program continues running

```
Error!  
PLC is running.  
Press OK button for  
more details.
```



2. Press and hold the  (OK) button. The error code is displayed.

```
▶General Error: 3  
Execution Error:0  
Clear Error
```



Error details can also be checked from **Error Status** on the system menu.

3. Select the error type with the  (up) and  (down) buttons and press the  (OK) button. Only errors that have occurred are displayed.

```
▶General Error: 3  
Power failure  
Watchdog Timer
```

4. Press the  (ESC) button.
5. Select **Clear Error** with the  (down) button and press the  (OK) button.

```
General Error: 3  
Execution Error:0  
▶Clear Error
```

6. Select **Yes** with the  (down) button and press the  (OK) button.

```
Do you want to  
clear error code?  
No  
▶Yes
```

General errors and user program execution error are cleared.

Note: For details on error information, see "General Error Codes" on page 13-3.

Checking Error Information from the System Menu

You can check error information from the system menu.

1. On the standard screen, press the  (ESC) +  (OK) buttons.
The system menu is displayed.
2. Select **Error Status** with the  (up) and  (down) buttons and press the  (OK) button.

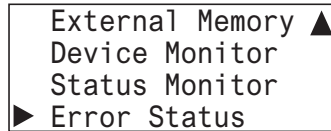

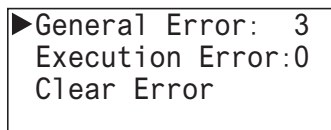

```
External Memory ▲
Device Monitor
Status Monitor
▶ Error Status
```

3. The error code is displayed.



```
▶ General Error: 3
Execution Error:0
Clear Error
```

4. Select the error type with the  (up) and  (down) buttons and press the  (OK) button.
Only errors that have occurred are displayed.

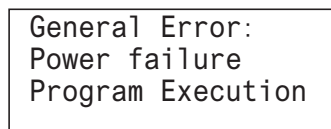

```
General Error:
Power failure
Program Execution
```

Displaying Arbitrary Messages

This section describes how to switch the message displayed on the LCD by executing the message (MSG) instruction.

Switching between Multiple Message Screens

When the display conditions for multiple MSG instructions are satisfied, the messages are displayed according to the priorities set for the MSG instructions.

The message with the highest priority is displayed, out of all the MSG instructions with the inputs on, by pressing the  (up) button on the standard screen.

By further pressing the  (up) button, the message with the next highest priority is displayed.

1. On the standard screen, press the  (up) button.

Running

2015/DEC/01/TUE

13:30:40

The message with the highest priority is displayed out of all the MSG instructions with the inputs on.

Today's production count

Type A: 10000 pcs.

Type B: 30000 pcs.

2. Press the  (up) button.
The message with the next highest priority is displayed.

Insufficient parts

Manu. Line Process 1

2015/06/01

3. Press the  (down) button.

Today's production count

Type A: 10000 pcs.

Type B: 30000 pcs.

4. Press the  (ESC) button to return to the standard screen.

Running

2015/DEC/01/TUE

13:30:40

For details on the MSG instruction, see Chapter 12 "Display Instructions" in the "FC6A Series MICROSmart Ladder Programming Manual".



SD Memory Card Maintenance

This section describes how to stop access to the SD memory card inserted into the CPU module and how to format the SD memory card.

Stopping Access to the SD Memory Card

Access to the SD memory card inserted into the CPU module is stopped using the HMI module buttons.

Access to the SD memory card can be stopped regardless of whether the user programming is running or stopped.

1. On the standard screen, press the  (ESC) +  (OK) buttons.

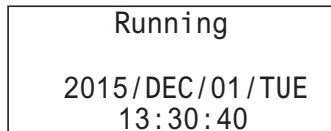

When the user program is running

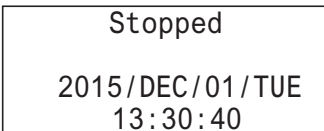

The system menu is displayed.

When the user program is stopped





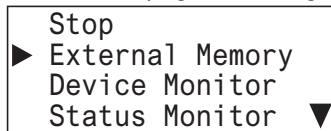

2. Select **External Memory** with the  (up) and  (down) buttons and press the  (OK) button.

When the user program is running

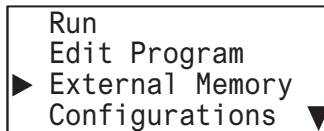

When the user program is stopped



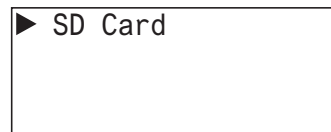

3. Select **SD Card** with the  (up) and  (down) buttons and press the  (OK) button.

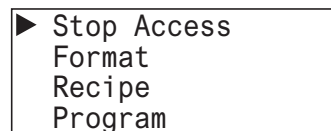

4. Select **Stop Access** with the  (up) and  (down) buttons and press the  (OK) button.



5. Select **Yes** with the  (down) button and press the  (OK) button.

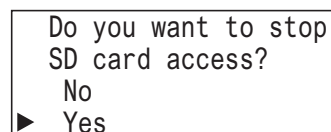

6. While the access to the SD memory card is being stopped, the screen below is displayed. When stopping the access is finished, the screen in step 4 is displayed.





Notes:

- Set the write-protect switch on the SD memory card to insert into the CPU module to the off position.
- Insert and remove the SD memory card in the direction indicated on the CPU module.
- Do not remove the SD memory card while the access to it is being stopped. There is a risk of damage to the SD memory card and the data stored on it. Check that the SD memory card status indicator LED [SD] is off and then remove the SD memory card from the CPU module.

Format SD memory card with the FC6A Series MICROSmart



The SD memory card inserted into the CPU module is formatted using the HMI module buttons. In order to save the log data, format the SD memory card with the CPU module.

The SD memory card can be formatted when the user program is stopped. The SD memory card cannot be formatted when the user program is running.

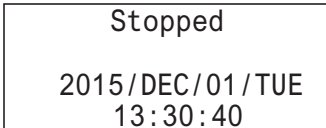

1. On the standard screen, press the  (ESC) +  (OK) buttons.





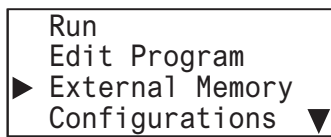

The system menu is displayed.

2. Select **External Memory** with the  (up) and  (down) buttons and press the  (OK) button.

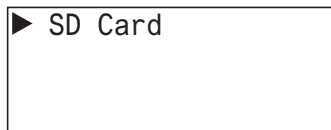



3. Select **SD Card** with the  (up) and  (down) buttons and press the  (OK) button.

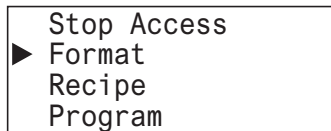

4. Select **Format** with the  (up) and  (down) buttons and press the  (OK) button.



5. Select **Yes** with the  (down) button and press the  (OK) button.

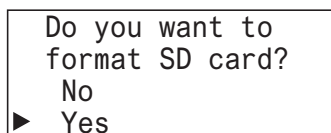



6. While the SD memory card is being formatted, the screen below is displayed. When the format is finished, the screen in step 4 is displayed.



Reading and Writing Recipe Files



This section describes how to write recipe files to the SD memory card and how to read recipe files from the SD memory card.

Writing Recipe Files (SD memory card → CPU module)

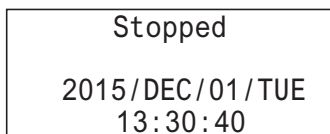

1. On the standard screen, press the  (ESC) +  (OK) buttons.





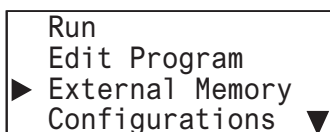

The system menu is displayed.

2. Select **External Memory** with the  (up) and  (down) buttons and press the  (OK) button.

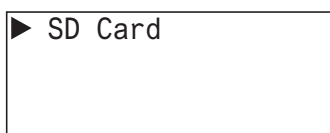

3. Select **SD Card** with the  (up) and  (down) buttons and press the  (OK) button.



4. Select **Recipe** with the  (up) and  (down) buttons and press the  (OK) button.

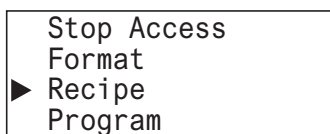

5. Select **Write Recipe** with the  (up) and  (down) buttons and press the  (OK) button.

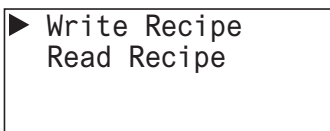

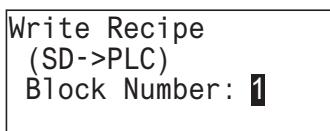

6. Select **Block Number** with the  (up) and  (down) buttons and press the  (OK) button.



7. While the recipe is being written, the screen below is displayed. When finished, the screen in step 5 is displayed.





Reading Recipe Files (CPU module → SD memory card)



1. On the standard screen, press the  (ESC) +  (OK) buttons.





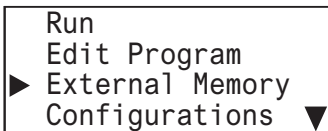

The system menu is displayed.

2. Select **External Memory** with the  (up) and  (down) buttons and press the  (OK) button.

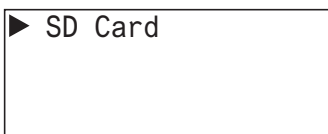

3. Select **SD Card** with the  (up) and  (down) buttons and press the  (OK) button.



4. Select **Recipe** with the  (up) and  (down) buttons and press the  (OK) button.

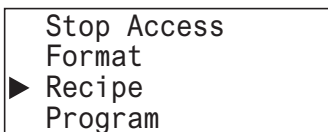

5. Select **Read Recipe** with the  (up) and  (down) buttons and press the  (OK) button.

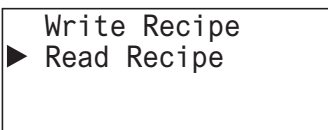

6. Select **Block Number** with the  (up) and  (down) buttons and press the  (OK) button.

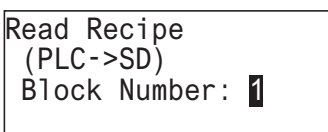

7. While the recipe is being read, the screen below is displayed. When finished, the screen in step 5 is displayed.





Uploading/Downloading the User Program

This section describes how to download the user program on the SD memory card to the CPU module and how to upload the user program on the CPU module to the SD memory card when the user program is stopped.



Downloading the User Program (SD memory card → CPU module)

Download the user program on the SD memory card to the CPU module.

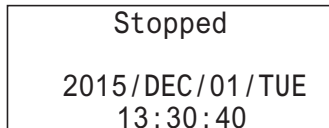

1. On the standard screen, press the  (ESC) +  (OK) buttons.

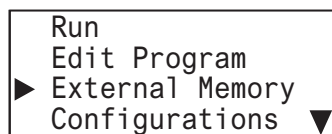

The system menu is displayed.

2. Select **External Memory** with the  (up) and  (down) buttons and press the  (OK) button.



3. Select **SD Card** with the  (up) and  (down) buttons and press the  (OK) button.

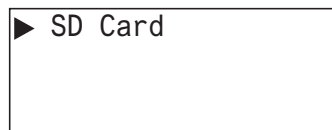

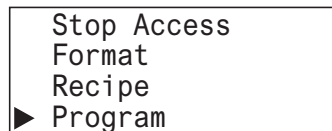

4. Select **Program** with the  (up) and  (down) buttons and press the  (OK) button.

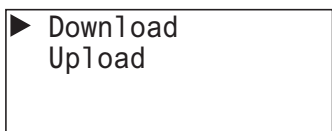

5. Select **Download** with the  (up) and  (down) buttons and press the  (OK) button.



6. Select the zld file to download with the  (up) and  (down) buttons and press the  (OK) button.^{*1}

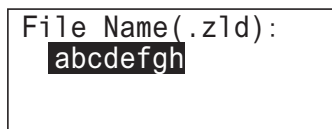

^{*1} Files that can be selected to download are zld files stored in the PROGRAM folder on the SD memory card.



7. The following screen is displayed when the user program is being downloaded^{*2}. When finished, the screen in step 4 is displayed.



^{*2} When downloading the system software, the system is reset during the download and the screen is reset to the standard screen.



Uploading the User Program (CPU module → SD memory card)

Upload the user program on the CPU module to the SD memory card.



1. On the standard screen, press the  (ESC) +  (OK) buttons.

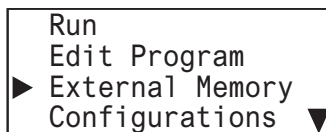

The system menu is displayed.

2. Select **External Memory** with the  (up) and  (down) buttons and press the  (OK) button.



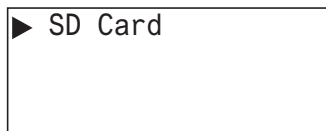

3. Select **SD Card** with the  (up) and  (down) buttons and press the  (OK) button.



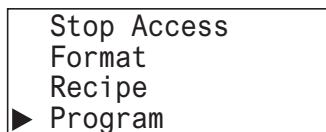



4. Select **Program** with the  (up) and  (down) buttons and press the  (OK) button.

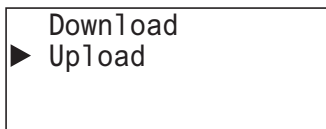

5. Select **Upload** with the  (up) and  (down) buttons and press the  (OK) button.



6. Enter the file name to create by the upload with the  (up),  (down),  (left), and  (right) buttons and press the  (OK) button.*1

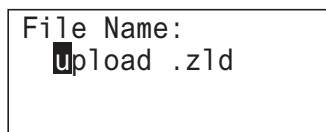

*1 The file name that can be entered is between one and eight characters in length. The file name is the entered value from the beginning to the space. The uploaded file is stored in the PROGRAM folder on the SD memory card.

7. The screen below is displayed while the user program is uploaded. When the upload is finished, the screen in step 4 is displayed.



System Menu Hierarchy Diagram

The HMI module system menu hierarchy is as follows. is displayed only when the Plus CPU module is connected.

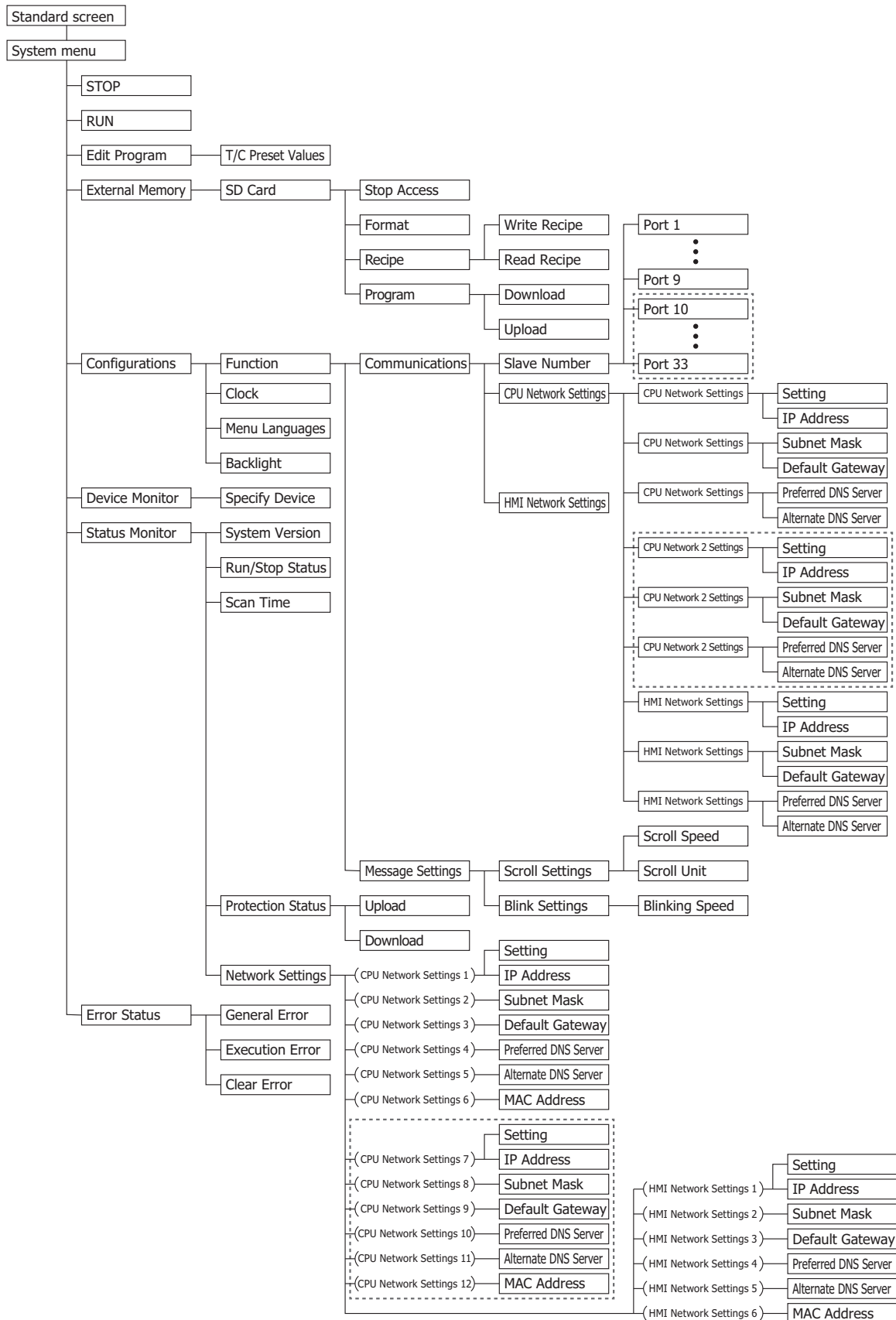

Communication Functions

This section describes the communication functions that can be used with the HMI module connected to the CPU module.

Connection Settings

The HMI module can relay (pass through) CPU module Ethernet communication using a maximum of eight connections.

The usable communication mode is maintenance communication server.

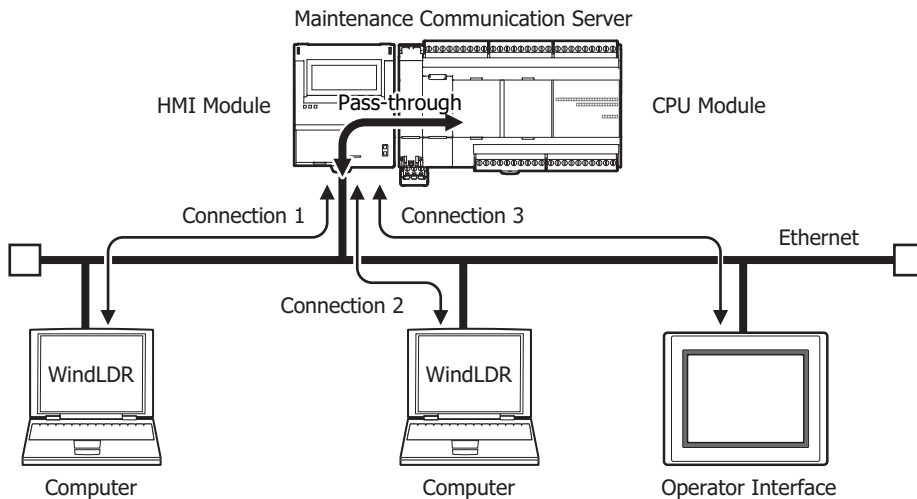

Notes:

- For details on the HMI module's network settings and connection settings, see Chapter 3 "Network Settings" in the "FC6A Series MICROSmart Communication Manual".
- For details on the maintenance communication server function, see Chapter 4 "Maintenance Communication via Ethernet Port 1" in the "FC6A Series MICROSmart Communication Manual".

Send e-mail function

Up to 255 types of e-mails can be sent by using the HMI module and executing the EMAIL instruction in the user program.

The character sets that can be used are ASCII, Japanese (ISO-2022-JP), Chinese (GB2312), Western European languages (ISO-8859-1), and Unicode (UFT-8).

For Japanese, the title can be set to 100 double-byte characters and the body can be set to around 1,600 characters. The values of data registers can also be embedded in the body of an e-mail.

Note: For details on the send e-mail function, see Chapter 12 "Send E-mail Function" in the "FC6A Series MICROSmart Communication Manual".

Web server function

Using the HMI module, the status of the CPU module can be checked and device values can be checked and modified with a web browser on a computer.

Web page data created by the user can also be downloaded to the HMI module. The HMI module can store a maximum of 5 MB of data.

Access controls can also be applied by using password authentication.

Note: For details on the web server function, see Chapter 13 "Web Server" in the "FC6A Series MICROSmart Communication Manual".

8: INSTRUCTIONS REFERENCE

Introduction

This chapter provides a list of FC6A Series MICROSmart instructions and describes their functions.

The instructions are divided into basic instructions, which perform sequencing, and advanced instructions, which perform moves, comparisons, Boolean computations, binary arithmetic operations, bit shifts, and other operations.

Basic Instruction List

Symbol	Name	Function	See Page (Ladder Programming Manual)
AND	And	Series connection of NO contact	4: Basic Instructions
AND LOD	And Load	Series connection of circuit blocks	
ANDN	And Not	Series connection of NC contact	
BPP	Bit Pop	Restores the result of bit logical operation which was saved temporarily	
BPS	Bit Push	Saves the result of bit logical operation temporarily	
BRD	Bit Read	Reads the result of bit logical operation which was saved temporarily	
CC=	Counter Comparison (=)	Equal to comparison of counter current value	
CC>=	Counter Comparison (>=)	Greater than or equal to comparison of counter current value	
CDP	Dual Pulse Reversible Counter	Dual pulse reversible counter (0 to 65,535)	
CDPD	Double-Word Dual Pulse Reversible Counter	Double-word dual pulse reversible counter (0 to 4,294,967,295)	
CNT	Adding Counter	Adding counter (0 to 65,535)	
CNTD	Double-Word Adding Counter	Double-word adding counter (0 to 4,294,967,295)	
CUD	Up/Down Selection Reversible Counter	Up/down selection reversible counter (0 to 65,535)	
CUDD	Double-Word Up/Down Selection Reversible Counter	Double-word up/down selection reversible counter (0 to 4,294,967,295)	
DC=	Data Register Comparison (=)	Equal to comparison of data register value	
DC>=	Data Register Comparison (>=)	Greater than or equal to comparison of data register value	
END	End	Ends a program	
JEND	Jump End	Ends a jump instruction	
JMP	Jump	Jumps a designated program area	
LOD	Load	Stores intermediate results and reads contact status	
LODN	Load Not	Stores intermediate results and reads inverted contact status	
MCR	Master Control Reset	Ends a master control	
MCS	Master Control Set	Starts a master control	
OR	Or	Parallel connection of NO contact	
OR LOD	Or Load	Parallel connection of circuit blocks	
ORN	Or Not	Parallel connection of NC contact	
OUT	Output	Outputs the result of bit logical operation	
OUTN	Output Not	Outputs the inverted result of bit logical operation	
RST	Reset	Resets output, internal relay, or shift register bit	
SET	Set	Sets output, internal relay, or shift register bit	
SFR	Shift Register	Forward shift register	
SFRN	Shift Register Not	Reverse shift register	
SOTD	Single Output Down	Falling-edge differentiation output	
SOTU	Single Output Up	Rising-edge differentiation output	

8: INSTRUCTIONS REFERENCE

Symbol	Name	Function	See Page (Ladder Programming Manual)
TIM	100-ms Timer	Subtracting 100-ms timer (0 to 6,553.5 s)	4: Basic Instructions
TIMO	100-ms Off-delay Timer	Subtracting 100-ms off-delay timer (0 to 6,553.5 s)	
TMH	10-ms Timer	Subtracting 10-ms timer (0 to 655.35 s)	
TMHO	10-ms Off-delay Timer	Subtracting 10-ms off-delay timer (0 to 655.35 s)	
TML	1-s Timer	Subtracting 1-s timer (0 to 65,535 s)	
TMLO	1-s Off-delay Timer	Subtracting 1-s off-delay timer (0 to 65,535 s)	
TMS	1-ms Timer	Subtracting 1-ms timer (0 to 65.535 s)	
TMSO	1-ms Off-delay Timer	Subtracting 1-ms off-delay timer (0 to 65.535 s)	

Advanced Instruction List

Group	Symbol	Name	Valid Data Type					See Page (Ladder Programming Manual)
			W	I	D	L	F	
NOP	NOP	No Operation						3: Instructions Reference
Move	MOV	Move	X	X	X	X	X	5: Move Instructions
	MOVN	Move Not	X	X	X	X		
	IMOV	Indirect Move	X		X		X	
	IMOVN	Indirect Move Not	X		X			
	MOVC	Move Characters						
	BMOV	Block Move	X					
	IBMV	Indirect Bit Move	X					
	IBMVN	Indirect Bit Move Not	X					
	NSET	N Data Set	X	X	X	X	X	
	NRS	N Data Repeat Set	X	X	X	X	X	
	XCHG	Exchange	X		X			
TCCST	Timer/Counter Current Value Store	X		X				
Data Comparison	CMP=	Compare Equal To	X	X	X	X	X	6: Data Comparison Instructions
	CMP<>	Compare Unequal To	X	X	X	X	X	
	CMP<	Compare Less Than	X	X	X	X	X	
	CMP>	Compare Greater Than	X	X	X	X	X	
	CMP<=	Compare Less Than or Equal To	X	X	X	X	X	
	CMP>=	Compare Greater Than or Equal To	X	X	X	X	X	
	ICMP>=	Interval Compare Greater Than or Equal To	X	X	X	X	X	
	LC=	Load Compare Equal To	X	X	X	X	X	
	LC<>	Load Compare Unequal To	X	X	X	X	X	
	LC<	Load Compare Less Than	X	X	X	X	X	
	LC>	Load Compare Greater Than	X	X	X	X	X	
	LC<=	Load Compare Less Than or Equal To	X	X	X	X	X	
	LC>=	Load Compare Greater Than or Equal To	X	X	X	X	X	
Binary Arithmetic	ADD	Addition	X	X	X	X	X	7: Binary Arithmetic Instructions
	SUB	Subtraction	X	X	X	X	X	
	MUL	Multiplication	X	X	X	X	X	
	DIV	Division	X	X	X	X	X	
	INC	Increment	X	X	X	X		
	DEC	Decrement	X	X	X	X		
	ROOT	Root	X		X		X	
	SUM	Sum (ADD)	X	X	X	X	X	
		Sum (XOR)	X					
RNDM	Random	X						
Boolean Computation	ANDW	AND Word	X		X			8: Boolean Computation Instructions
	ORW	OR Word	X		X			
	XORW	Exclusive OR Word	X		X			
Shift and Rotate	SFTL	Shift Left						9: Shift / Rotate Instructions
	SFTR	Shift Right						
	BCDLS	BCD Left Shift			X			
	WSFT	Word Shift	X					
	ROTL	Rotate Left	X		X			
	ROTR	Rotate Right	X		X			

8: INSTRUCTIONS REFERENCE

Group	Symbol	Name	Valid Data Type					See Page (Ladder Programming Manual)
			W	I	D	L	F	
Data Conversion	HDOB	Hex to BCD	X		X			10: Data Conversion Instructions
	BTOH	BCD to Hex	X		X			
	HTOA	Hex to ASCII	X					
	ATOH	ASCII to Hex	X					
	BTOA	BCD to ASCII	X		X			
	ATOB	ASCII to BCD	X		X			
	ENCO	Encode						
	DECO	Decode						
	BCNT	Bit Count						
	ALT	Alternate Output						
	CVDT	Convert Data Type	X	X	X	X	X	
	DTDV	Data Divide	X					
	DTCB	Data Combine	X					
	SWAP	Data Swap	X		X			
Week Programmer	WKTIM	Week Timer						11: Week Programmer Instructions
	WKTBL	Week Table						
	WEEK	Weekly Timer						
	YEAR	Yearly Timer						
Interface	MSG	Message						12: Display Instructions
	DISP	Display						
	DGRD	Digital Read						
Program Branching	LABEL	Label						13: Program Branching Instructions
	LJMP	Label Jump						
	LCAL	Label Call						
	LRET	Label Return						
	DJNZ	Decrement Jump Non-zero						15: Interrupt Control Instructions
	DI	Disable Interrupt						
	EI	Enable Interrupt						
	IOREF	I/O Refresh						14: Refresh Instructions
	HSCRF	High-speed Counter Refresh						
	FRQRF	Frequency Measurement Refresh						
COMRF	Communication Refresh							
Coordinate Conversion	XYFS	XY Format Set	X	X				16: Coordinate Conversion Instructions
	CVXTY	Convert X to Y	X	X				
	CVYTX	Convert Y to X	X	X				
	AVRG	Average	X	X	X	X	X	17: Average Instructions
Pulse	PULS1	Pulse Output 1						18: Pulse Output Instructions
	PULS2	Pulse Output 2						
	PULS3	Pulse Output 3						
	PULS4	Pulse Output 4						
	PWM1	Pulse Width Modulation 1						
	PWM2	Pulse Width Modulation 2						
	PWM3	Pulse Width Modulation 3						
	PWM4	Pulse Width Modulation 4						
	RAMP1	Ramp Pulse Output 1						
	RAMP2	Ramp Pulse Output 2						
	RAMPL	Linear Interpolation Control						
	ZRN1	Zero Return 1						
	ZRN2	Zero Return 2						
	ARAMP1	Advanced Ramp 1						
	ARAMP2	Advanced Ramp 2						
	ABS	Set Absolute Position						
	JOG	JOG Operation						

Group	Symbol	Name	Valid Data Type					See Page (Ladder Programming Manual)
			W	I	D	L	F	
PID Control	PID	PID Control (FC5A compatible)						19: PID Control Instructions
	PIDA	PID Control						
	PIDD	PID with Derivative Decay						
Dual / Teaching Timer	DTML	1-s Dual Timer						20: Dual / Teaching Timer Instructions
	DTIM	100-ms Dual Timer						
	DTMH	10-ms Dual Timer						
	DTMS	1-ms Dual Timer						
	TTIM	Teaching Timer						
Trigonometric Function	RAD	Degree to Radian					X	21: Trigonometric Function Instructions
	DEG	Radian to Degree					X	
	SIN	Sine					X	
	COS	Cosine					X	
	TAN	Tangent					X	
	ASIN	Arc Sine					X	
	ACOS	Arc Cosine					X	
ATAN	Arc Tangent					X		
Logarithm / Power	LOGE	Natural Logarithm					X	22: Logarithm / Power Instructions
	LOG10	Common Logarithm					X	
	EXP	Exponent					X	
	POW	Power					X	
File Data Processing	FIFO	FIFO Format	X					23: File Data Processing Instructions
	FIEX	First-In Execute	X					
	FOEX	First-Out Execute	X					
	NDSRC	N Data Search	X	X	X	X	X	
Clock	TADD	Time Addition						24: Clock Instructions
	TSUB	Time Subtraction						
	HTOS	HMS to S						
	STOH	S to HMS						
	HOUR	Hour Meter						
Data Logging	DLOG	Data Logging						25: Data Log Instructions
	TRACE	Data Trace						
Script	SCRPT	Script	X	X	X	X	X	26: Script
Flow Volume Calculation	SCALE	Convert Analog Input	X	X				27: Flow Calculation Instructions
	FLWA	Analog Flow Totalizer						
	FLWP	Pulse Flow Totalizer	X		X			
User-defined Macro	UMACRO	User-defined Macro						28: User-defined Macro Instruction
User Communication	TXD	Transmit						Communication Manual 5: User Communication Instructions
	ETXD	Transmit over Ethernet						
	RXD	Receive						
	ERXD	Receive over Ethernet						
PING	PING	Ping						Communication Manual 11: Send PING Function
E-mail	EMAIL	Send E-mail						Communication Manual 12: Send E-mail Function

Structure of an Advanced Instruction

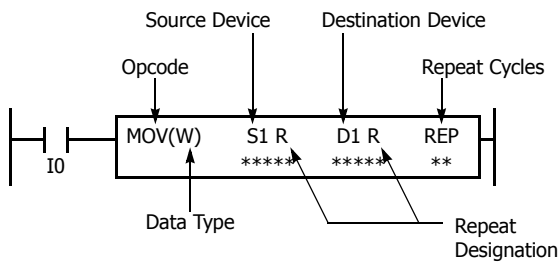

Repeat Designation

Specifies whether repeat is used for the device or not.

Repeat Cycles

Specifies the quantity of repeat cycles: 1 through 99.

Opcode

The opcode is a symbol used to identify the advanced instruction.

Data Type

Specifies word (W), integer (I), double word (D), long (L), or float (F) data.

Source Device

The source device specifies the 16- or 32-bit data to be processed by the advanced instruction. Some advanced instructions require two source devices.

Destination Device

The destination device specifies the 16- or 32-bit data to store the result of the advanced instruction. Some advanced instructions require two destination devices.

Input Condition for Advanced Instructions

Almost all advanced instructions must be preceded by a contact, except NOP (no operation), LABEL (label), and LRET (label return) instructions. The input condition can be programmed using a bit device such as input, output, internal relay, or shift register. Timer and counter can also be used as an input condition to turn on the contact when the timer times out or the counter counts out.

While the input condition is on, the advanced instruction is executed in each scan. To execute the advanced instruction only at the rising or falling edge of the input, use the SOTU or SOTD instruction.

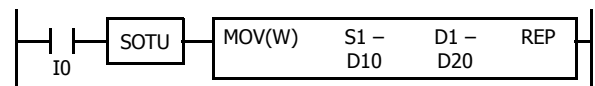

While the input condition is off, the advanced instruction is not executed and device statuses are held.

Source and Destination Devices

The source and destination devices specify 16- or 32-bit data, depending on the selected data type. When a bit device such as input, output, internal relay, or shift register is designated as a source or destination device, 16 or 32 points starting with the designated number are processed as source or destination data. When a word device such as timer or counter is designated as a source device, the current value is read as source data. When a timer or counter is designated as a destination device, the result of the advanced instruction is set to the preset value for the timer or counter. When a data register is designated as a source or destination device, the data is read from or written to the designated data register.

Using Timer or Counter as Source Device

Since all timer instructions—TML (1-s timer), TIM (100-ms timer), TMH (10-ms timer), and TMS (1-ms timer)—subtract from the preset value, the current value is decremented from the preset value and indicates the remaining time. As described above, when a timer is designated as a source device of an advanced instruction, the current value, or the remaining time, of the timer is read as source data. Adding counters CNT start counting at 0, and the current value is incremented up to the preset value. Reversible counters CDP and CUD start counting at the preset value and the current value is incremented or decremented from the preset value. When any counter is designated as a source device of an advanced instruction, the current value is read as source data.

Using Timer or Counter as Destination Device

As described above, when a timer or counter is designated as a destination device of an advanced instruction, the result of the advanced instruction is set to the preset value of the timer or counter. Timer and counter preset values can be 0 through 65,535. When a timer or counter preset value is designated using a data register, the timer or counter cannot be designated as a destination of an advanced instruction. When executing such an advanced instruction, a user program execution error will result. For details of user program execution error, see "User Program Execution Error" on page 13-6.

Note: When a user program execution error occurs, the result is not set to the destination.

Data Types for Advanced Instructions

When using move, data comparison, binary arithmetic, Boolean computation, bit shift/rotate, data conversion, and coordinate conversion instructions, data types can be selected from word (W), integer (I), double word (D), long (L), or float (F). For other advanced instructions, the data is processed in units of 16-bit word.

Data Type	Symbol	Bits	Quantity of Data Registers Used	Range of Decimal Values	
				Decimal	Hexdecimal
Word (Unsigned 16 bits)	W	16 bits	1	0 to 65,535	\$0000 to \$FFFF
Integer (Signed 16 bits)	I	16 bits	1	-32,768 to 32,767	\$8000 to \$7FFF
Double Word (Unsigned 32 bits)	D	32 bits	2	0 to 4,294,967,295	\$00000000 to \$FFFFFFFF
Long (Signed 32 bits)	L	32 bits	2	-2,147,483,648 to 2,147,483,647	\$80000000 to \$7FFFFFFF
Float (Floating point)	F	32 bits	2	-3.402823×10 ³⁸ to 3.402823×10 ³⁸	—

- When a constant is set in WindLDR, it can be set as decimal or hexadecimal number. Prefix the number with "\$" to set it as a hexadecimal number.

Decimal Values and Hexadecimal Storage (Word, Integer, Double, and Long Data)

The following table shows hexadecimal equivalents which are stored in the CPU, as a result of addition and subtraction of the decimal values shown:

Data Type	Result of Addition	Hexadecimal Storage	Result of Subtraction	Hexadecimal Storage
Word	0	0000	65,535	FFFF
	65,535	FFFF	0	0000
	131,071	(CY) FFFF	-1	(BW) FFFF
			-65,535	(BW) 0001
			-65,536	(BW) 0000
Integer	65,534	(CY) 7FFE	65,534	(BW) 7FFE
	32,768	(CY) 0000	32,768	(BW) 0000
	32,767	7FFF	32,767	7FFF
	0	0000	0	0000
	-1	FFFF	-1	FFFF
	-32,767	8001	-32,767	8001
	-32,768	8000	-32,768	8000
	-32,769	(CY) FFFF	-32,769	(BW) FFFF
	-65,535	(CY) 8001	-65,535	(BW) 8001
Double Word	0	00000000	4,294,967,295	FFFFFFFF
	4,294,967,295	FFFFFFFF	0	00000000
	8,589,934,591	(CY) FFFFFFFF	-1	(BW) FFFFFFFF
			-4,294,967,295	(BW) 00000001
Long	4,294,967,294	(CY) 7FFFFFFE	4,294,967,294	(BW) 7FFFFFFE
	2,147,483,648	(CY) 00000000	2,147,483,648	(BW) 00000000
	2,147,483,647	7FFFFFFF	2,147,483,647	7FFFFFFF
	0	00000000	0	00000000
	-1	FFFFFFFF	-1	FFFFFFFF
	-2,147,483,647	80000001	-2,147,483,647	80000001
	-2,147,483,648	80000000	-2,147,483,648	80000000
	-2,147,483,649	(CY) FFFFFFFF	-2,147,483,649	(BW) FFFFFFFF
	-4,294,967,295	(CY) 80000001	-4,294,967,295	(BW) 80000001

Floating-Point Data Format

The FC6A Series MICROSmart can specify floating-point data (F) for advanced instructions. Like double word (D) and long integer (L) data, floating-point data also uses two consecutive data registers to execute advanced instructions. The FC6A Series MICROSmart supports the floating-point data based on the single storage format of the IEEE (The Institute of Electrical and Electronics Engineers) Standard 754.

Single Storage Format

The IEEE single storage format consists of three fields: a 23-bit fraction, *f*; an 8-bit biased exponent, *e*; and 1-bit sign, *s*. These fields are stored contiguously in one 32-bit word, as shown in the figure below. Bits 0:22 contain the 23-bit fraction, *f*, with bit 0 being the least significant bit of the fraction and bit 22 being the most significant; bits 23:30 contain the 8-bit biased exponent, *e*, with bit 23 being the least significant bit of the biased exponent and bit 30 being the most significant; and the highest-order bit 31 contains the sign bit, *s*.

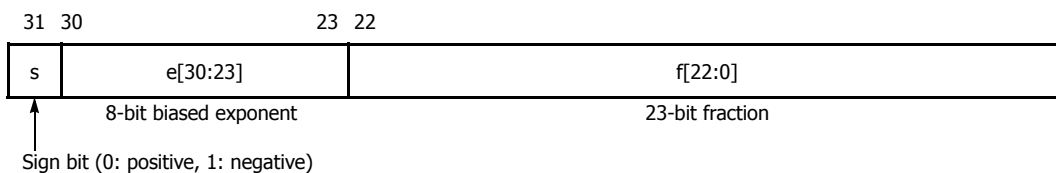

The table below shows the correspondence between the values of the three constituent fields *s*, *e*, and *f* and the value represented by the single storage format bit pattern. When any value out of the bit pattern is entered to the advanced instruction or when execution of advanced instructions, such as division by zero, has produced any value out of the bit pattern, a user program execution error will result, turning on special internal relay M8004 and the ERR LED on the FC6A Series MICROSmart.

Value	Exponent Field <i>e</i>	Fraction Field <i>f</i>	Representation in WindLDR
±0	e=0	f=0	0.0
Denormal numbers	e=0	f≠0	-1.175494E-38 to 1.175494E-38
Normal numbers	0< <i>e</i> <255	Arbitrary	-3.402823E+38 to -1.175494E-38 1.175494E-38 to 3.402823E+38
±∞ (± infinities)	e=255	f=0	INF
NaNs (Not a number values)		f≠0	NAN

Carry and Borrow in Floating-Point Data Processing

When advanced instructions involving floating-point data are executed, special internal relay M8003 (carry and borrow) is updated.

M8003	Execution Result	Value
1	≠ 0	Overflow (exceeds the range between -3.402823×10^{38} and 3.402823×10^{38})
1	0	Not zero (within the range between $-1.175495 \times 10^{-38}$ and 1.175495×10^{-38})
0	0	Zero

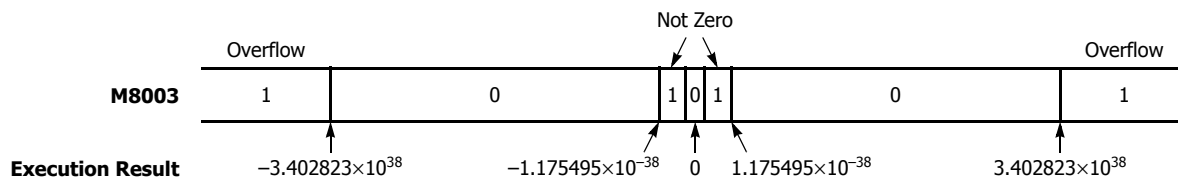

32-bit Data Storage

The 32-bit data for D (double word) and L (long word) is stored in devices according to the method selected in WinLDR under **Device Settings in Function Area Settings**.

For applicable devices and instructions, see "32-bit Data Storage Setting" on page 5-56.

Word devices*¹: The data storage when **From Upper Word** is selected under **Device Settings**

When D0 is specified as the source or destination device, the upper word is stored in D0 and the lower word is stored in D1.

Double word data (constant)

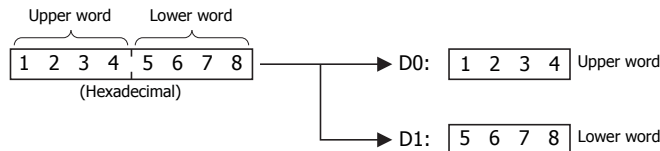

The data storage when **From Lower Word** is selected under **Device Settings**

When D0 is specified as the source or destination device, the lower word is stored in D0 and the upper word is stored in D1.

Double word data (constant)

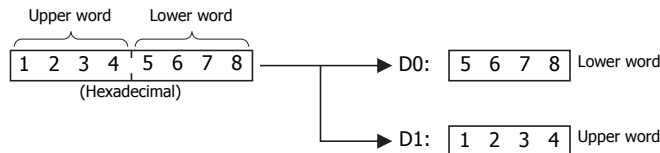

Bit devices*¹:

The data storage when **From Upper Word** is selected under **Device Settings**

When R0 is specified as the source or destination device, the upper word is stored in R0 to R15 and the lower word is stored in R16 to R31.

Double word data (constant)

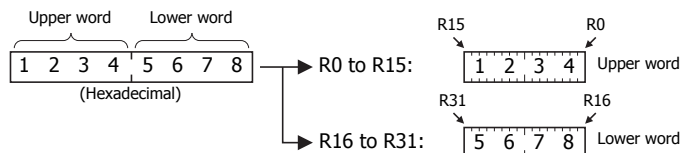

The data storage when **From Lower Word** is selected under **Device Settings**

When R0 is specified as the source or destination device, the lower word is stored in R0-R15 and the upper word is stored in R16-R31.

Double word data (constant)

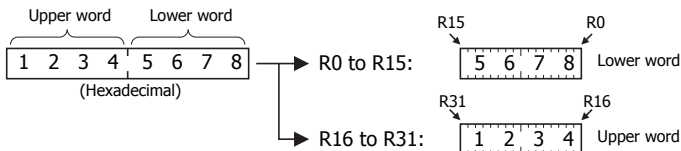

*1 For bit devices and word devices, see "Devices" on page 6-1.

User Program Execution Errors

When an advanced instruction is executed, a user program execution error occurs when any of the following conditions are met.

- the result of the advanced instruction is invalid
- source or destination device that is indirectly specified in the advanced instruction exceeds the valid device range
- the advanced instruction does not operate correctly

For example, the data in the source device does not comply with the normal floating-point format when the data type is Float (F). For details about device ranges, see "Devices" on page 6-1.

When a user program execution error occurs, special internal relay M8004 turns on and the corresponding error code is stored in special data register D8006. For details about the error codes, see "User Program Execution Error" on page 13-6.

When a user program execution error occurs, instructions operate as follows:

- When the source data is invalid, the execution of the advanced instruction is canceled and the data in the destination device is not changed.
- When the execution result is invalid, a value is stored in the destination device.
For details on stored values, see the descriptions of relevant instructions.
- If a user program execution error occurred during a repeat operation, the operation is canceled and the next repeat operation is executed. M8004 is retained even when no further user program execution errors occur during subsequent repeat operations.

Example: User program execution error during a repeat operation

When the source data does not comply with the normal floating-point format.

When the second repeat operation is executed, special internal relay M8004 turns on because the source data is not a normal number in floating-point format.

The second repeat operation is canceled and the third repeat operation is executed.

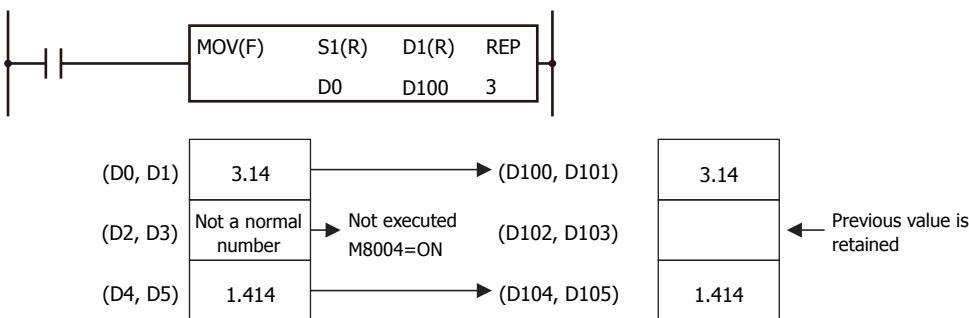

Carry and Borrow

When the result of an operation exceeds the valid device range, a carry (CY) or borrow (BW) occurs.

Carrying and borrowing occur in the following conditions according to the data type:

Data Type	Status
Word	Exceeds range between 0 and 65,535
Integer	Exceeds range between -32,768 and 32,767
Double Word	Exceeds range between 0 and 4,294,967,295
Long	Exceeds range between -2,147,483,648 and 2,147,483,647
Float	If an overflow or underflow occurs For details on overflow and underflow, see "Carry and Borrow in Floating-Point Data Processing" on page 8-8.

When a carry or borrow occurs, special internal relay M8003 (carry and borrow) turns on.

For example, when D0 has a value of FFFF (hex) and +1 is added using an INC instruction, the result is 10000 (hex), but when the data type is Word (W), 0000 (hex) is stored in D0 and 1 is stored in M8003.

Discontinuity of Device Areas

Each device area is discrete and does not continue, for example, from input to output or from output to internal relay. In addition, special internal relays M8000 through M8997 are in a separate area from internal relays M0 through M7997 and M10000 through M21247. Data registers D0 through D7999, D10000 through D61999, and D70000 through D269999, and special data registers D8000 through D8899 are in separate areas and do not continue with each other.

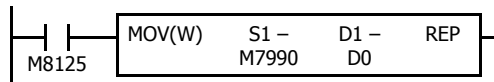

The internal relay ends at M7997. Since the MOV (move) instruction reads 16 internal relays, the last internal relay exceeds the valid range, resulting in a user program syntax error.

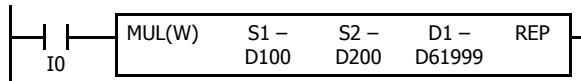

This program results in a user program syntax error. The destination of the MUL (multiplication) instruction requires two data registers D61999 and D62000. Since D62000 exceeds the valid range, a user program syntax error occurs.

Advanced instructions execute operation only on the available devices in the valid area. If a user program syntax error is found during programming, WindLDR rejects the program instruction and shows an error message.

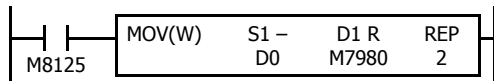

The MOV (move) instruction sets data of data register D0 to 16 internal relays M7980 through M7997 in the first repeat cycle. The destination of the second cycle is the next 16 internal relays M8000 through M8017, which are invalid, resulting in a user program syntax error.

For details about repeat operations of each advanced instruction, see "Advanced Instruction List" on page 8-3.

NOP (No Operation)

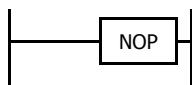

No operation is executed by the NOP instruction.

The NOP instruction may serve as a place holder. It can also be used to add a delay to the CPU scan time, in order to simulate communication with a machine or application, for debugging purposes.

The NOP instruction does not require an input and device.

Details of the other advanced instructions are described in the following chapters.

Device Addressing for Instruction Execution

This section provides an explanation about how source and destination devices used by instructions for the execution can be specified. There are two ways to specify the device to use: Direct Addressing and Indirect Addressing.

Direct Addressing

In direct addressing, source and destination devices are specified with the devices to use.

■ Direct Addressing Operation

Example: When the source device (D0010) of the MOV(W) is directly specified.
The data in D0010 is transferred to D0002.

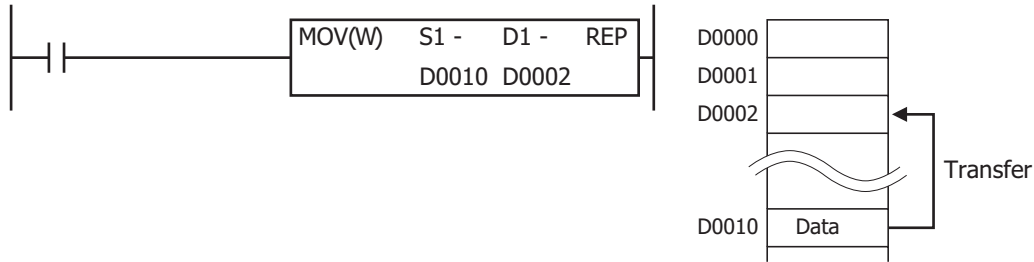

■ Devices that can be directly addressed

I	Q	M	R	T	C	D	P	Constant
X	X	X	X	X	X	X	X	X

■ Instructions supporting the direct addressing

All basic and advanced instructions support the direct addressing.

Indirect Addressing

Indirect Addressing Format

The index register Pn indicates the offset from the base device. Indirect addressing is possible by specifying source devices and destination devices with the base device and the index register. The format of the indirect addressing is as follows:

"Base Device" + ":" + "Pn (Address n of the index register)"

Example: When the base device is D0010 and the index register P3 is used.
After D0010, add ":" and "P3".
D0010:P3

Indirect Addressing Operation

Example: When the source device (D0010) of the MOV(W) instruction is indirectly specified with P3.
The data in P3 is added to the address of D0010, so $D(10 + (P3)) = D(10 + (100)) = D0110$, and the data in D0110 is transferred to D0002.

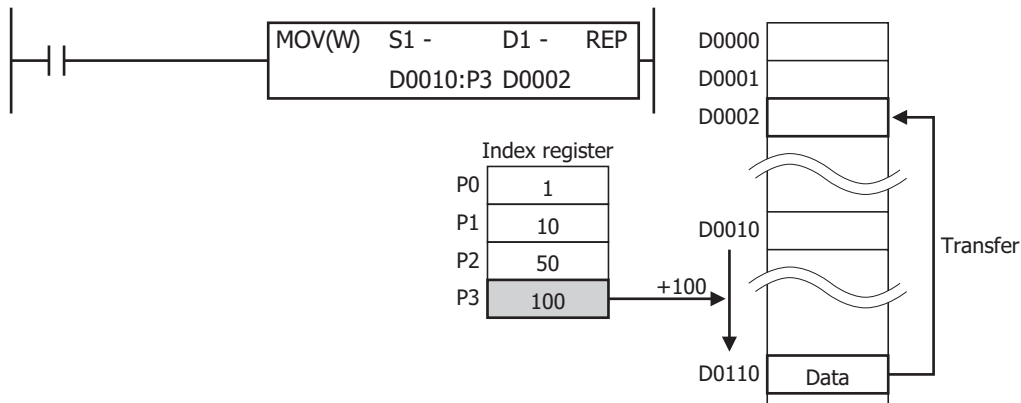

Index Registers

16 index registers (P0 to P15) can be used, and the data type of the index register is L (long).

Example: LOD M10:P0

- P0=-3
This indirect addressing indicates M0005, which is 3 bits behind of M0010.

- P0=5
This indirect addressing indicates M0015, which is five bits ahead of M0010.

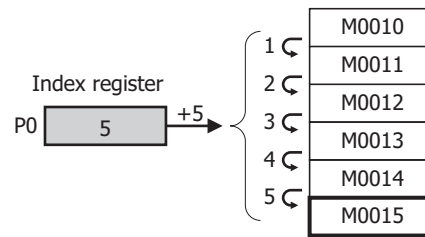
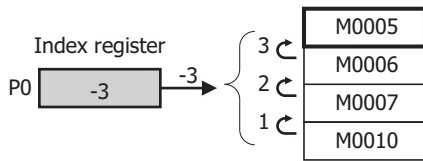
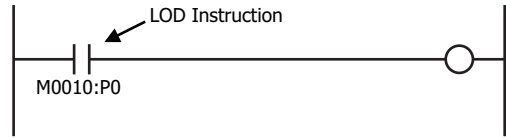
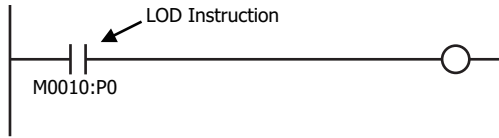

- P0=10
This indirect addressing indicates M0022, which is 10 bits ahead of M0010.

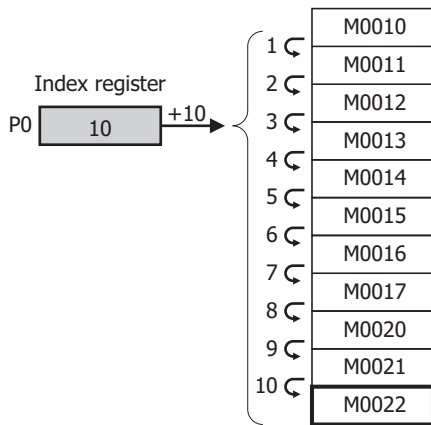
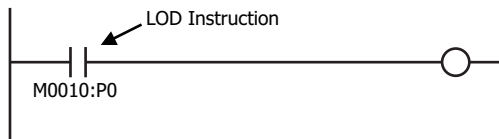

8: INSTRUCTIONS REFERENCE

Example: MOV(D) 1234 D10:P0

- P0=-3
This indirect addressing indicates D0007, which is 3 words behind of D0010.

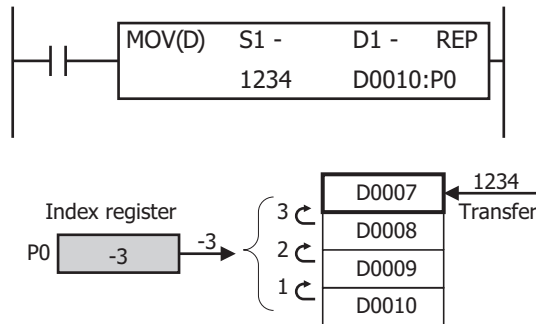

- P0=5
This indirect addressing indicates D0015, which is 5 words ahead of D0010.

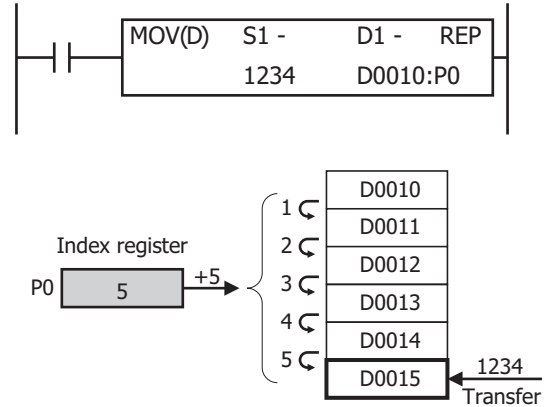

Values stored in the index registers is 32-bit and its data type is L (long). Index registers can directly specified as source and destination devices in MOV(L), ADD(L), SUB(L), and MUL(L) instructions and values in index registers can be moved or manipulated.

Example: MOV(L) -123456 P0

- -123456 is transferred to P0.

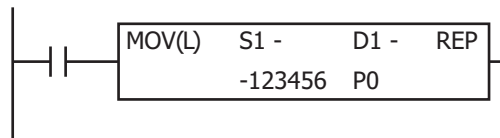

Notes:

- Index registers cannot be used in scripts.
- Indirect addressing to a different device type is not possible.
- If indirectly specified devices are beyond the device range, a user program execution error (1: Source/destination device exceeds range) will occur.
- When the indirect addressing is used, the base device and index register cannot be specified with the tag names.
- Indirect addressing for data register bits is not supported.
- The four instructions that can be used to modify the values of the index registers are MOV(L), ADD(L), SUB(L), and MUL(L). Specify P (index register) directly in those instructions.

Devices that can be indirectly addressed

I	Q	M	R	T	C	D	P	Constant
X	X	X	X	X	X	X	—	—

Instructions supporting the indirect addressing

■ Basic Instructions

Command	Indirect Addressing	Comments
LOD, LODN	X	Not possible when specifying a bit in a data register.
OUT, OUTN	X	Not possible when specifying a bit in a data register.
SET, RST	X	Not possible when specifying a bit in a data register.
AND, ANDN	X	Not possible when specifying a bit in a data register.
OR, ORN	X	Not possible when specifying a bit in a data register.
AND LOD	—	
OR LOD	—	
BPS, BRD, BPP	—	

Command	Indirect Addressing	Comments
TML, TIM, TMH, TIMS, TMLO, TIMO, TMHO, TIMSO	—	Indirect addressing is not supported because unique numbers are allocated.
CNT, CDP, CUD, CNTD, CDPD, CUDD	—	Indirect addressing is not supported because unique numbers are allocated.
CC=, CC>=, DC=, DC>=	—	
SFR, SFRN	—	
SOTU, SOTD	—	
MCS, MCR	—	
JMP, JEND	—	
END	—	

■ Advanced Instructions

Instruction	Indirect Addressing	Comments
NOP	—	
MOV, MOVN	X	
IMOV, IMOVN	—	
MOVC	X	
BMOV	X	
IBMV, IBMVN	—	
NSET	X	
NRS	X	
XCHG	X	
TCCST	X	
CMP=, CMP<>, CMP<, CMP>, CMP<=, CMP>=	X	
ICMP>=	X	
LC=, LC<>, LC<, LC>, LC<=, LC>=	X	
ADD	X	
SUB	X	
MUL	X	
DIV	X	
INC	X	
DEC	X	
ROOT	X	
SUM	X	
RNDM	X	
ANDW	X	
ORW	X	
XORW	X	
SFTL, SFTR	X	
BCDLS	X	
WSFT	X	
ROTL, ROTR	X	
HTOB	X	
BTOH	X	
HTOA	X	
ATOH	X	
BTOA	X	
ATOB	X	
ENCO	—	
DECO	—	
BCNT	X	
ALT	X	
CVDT	X	

8: INSTRUCTIONS REFERENCE

Instruction	Indirect Addressing	Comments
DTDV	X	
DTCB	X	
SWAP	X	
WKTIM	—	
WKTBL	—	
WEEK	—	
YEAR	—	
MSG	—	
DISP	—	
DGRD	—	
LABEL	—	
LJMP	—	
LCAL	—	
LRET	—	
DJNZ	—	
IOREF	—	
HSCRF	—	
FRQRF	—	
COMRF	—	
DI	—	
EI	—	
XYFS	—	
CVXTY	—	
CVYTX	—	
AVRG	—	
PULS	—	
PWM	—	
RAMP	—	
RAMPL	—	
ZRN	—	
ARAMP	—	
ABS	—	
JOG	—	
PID	—	
PIDA	—	
PIDD	—	
DTML, DTIM, DTMH, DTMS	—	
TTIM	—	
RAD	X	
DEG	X	
SIN	X	
COS	X	
TAN	X	
ASIN	X	
ACOS	X	
ATAN	X	
LOGE	X	
LOG10	X	
EXP	X	
POW	X	
FIFO	—	
FIEX	—	
FOEX	—	
NDSRC	—	
TADD	—	

Instruction	Indirect Addressing	Comments
TSUB	—	
HOUR	—	
HTOS	—	
STOH	—	
DLOG	—	
TRACE	—	
SCRPT	—	Index registers cannot be used in scripts.
SCALE	—	
FLWA	—	
FLWP	—	
UMACRO	—	Indirect addressing is possible in the instructions programmed in user-defined macros.
TXD, RXD, ETXD, ERXD	—	
PING	—	
EMAIL	—	

9: ANALOG I/O MODULES

This chapter describes the configuration of the analog I/O modules, as well as their parameters, device allocations, and WindLDR configuration methods.

Analog I/O Module Overview

This section provides an overview of the analog I/O modules and describes their types and the maximum number of modules that can be connected to the CPU module.

Analog I/O modules are available that allow the FC6A Series MICROSmart to directly handle analog data such as voltage, current, and temperature. There are ten types of analog I/O modules that differ by the number of analog inputs and outputs and the operation mode. These analog I/O modules can be used by connecting them to the right side of the CPU module. Analog I/O module inputs support voltage, current, thermocouples, resistance thermometers, and thermistors. Analog I/O module outputs support voltage and current.

To use an analog I/O module, it must be configured in the Module Configuration Editor. For detailed configuration methods, see "Module Configuration Editor" on page 12-1. For details on the analog I/O module parameter settings, see "Analog I/O Module Parameter Settings" on page 9-4.

Analog I/O Module List

This section shows a list of the analog I/O modules.

Module Type	Type No.	Points		Input Type						Output Type	
		Inputs	Outputs	Voltage	Current	Thermocouple	Resistance Thermometer	Thermistor	Resistance measurement	Voltage	Current
Analog input module	FC6A-J2C1 FC6A-J2C4	2	—	0 to 10 V/ -10 to +10 V	0 to 20 mA/ 4 to 20 mA	—	—	—	—	—	—
	FC6A-J4A1 FC6A-J4A4	4	—	0 to 10 V/ -10 to +10 V	0 to 20 mA/ 4 to 20 mA	—	—	—	—	—	
	FC6A-J8A1 FC6A-J8A4	8	—	0 to 10 V/ -10 to +10 V	0 to 20 mA/ 4 to 20 mA	—	—	—	—	—	
	FC6A-J4CN1 FC6A-J4CN4	4	—	0 to 10 V/ -10 to +10 V	0 to 20 mA/ 4 to 20 mA	K/ J/ R/ S/ B/ E/ T/ N/ C	Pt100/ Pt1000/ Ni100/ Ni1000/	—	—	—	
	FC6A-J4CH1Y FC6A-J4CH4Y	4	—	—	—	K/ J/ R/ S/ B/ E/ T/ N/ C	—	—	—	—	
	FC6A-J8CU1 FC6A-J8CU4	8	—	—	—	K/ J/ R/ S/ B/ E/ T/ N/ C	—	NTC/PTC	100 to 10,000 Ω	—	
	FC6A-K2A1 FC6A-K2A4	—	2	—	—	—	—	—	—	0 to 10V/ -10 to +10V	0 to 20mA/ 4 to 20mA
Analog output module	FC6A-K4A1 FC6A-K4A4	—	4	—	—	—	—	—	—	0 to 10 V/ -10 to +10 V	0 to 20 mA/ 4 to 20 mA
	Mixed analog I/O module	FC6A-L06A1 FC6A-L06A4	4	—	0 to 10 V/ -10 to +10 V	0 to 20 mA/ 4 to 20 mA	—	—	—	—	—
FC6A-L03CN1 FC6A-L03CN4		—	2	—	—	—	—	—	—	0 to 10 V/ -10 to +10 V	0 to 20 mA/ 4 to 20 mA
FC6A-L03CN1 FC6A-L03CN4		2	—	0 to 10 V/ -10 to +10 V	0 to 20 mA/ 4 to 20 mA	K/ J/ R/ S/ B/ E/ T/ N/ C	Pt100/ Pt1000/ Ni100/ Ni1000/	—	—	—	
FC6A-L03CN1 FC6A-L03CN4		—	1	—	—	—	—	—	—	0 to 10 V/ -10 to +10 V	0 to 20 mA/ 4 to 20 mA

9: ANALOG I/O MODULES

Quantity of Applicable Analog I/O Modules

The maximum number of analog I/O modules that can be connected to the CPU module depends on the CPU module.

CPU Module		Type No.	Quantity of Applicable Analog I/O Modules
All-in-One CPU module	All-in-One CPU module	FC6A-C16R1AE, FC6A-C16R4AE	4 modules + 8 modules* ¹
		FC6A-C16R1CE, FC6A-C16R4CE	
		FC6A-C16K1CE, FC6A-C16K4CE	
		FC6A-C16P1CE, FC6A-C16P4CE	
		FC6A-C16R1DE, FC6A-C16R4DE	
		FC6A-C16K1DE, FC6A-C16K4DE	
		FC6A-C16P1DE, FC6A-C16P4DE	
		FC6A-C24R1AE, FC6A-C24R4AE	
		FC6A-C24R1CE, FC6A-C24R4CE	
		FC6A-C24K1CE, FC6A-C24K4CE	
		FC6A-C24P1CE, FC6A-C24P4CE	
		FC6A-C40R1AE, FC6A-C40R4AE	
		FC6A-C40R1CE, FC6A-C40R4CE	
		FC6A-C40K1CE, FC6A-C40K4CE	
	FC6A-C40P1CE, FC6A-C40P4CE		
	FC6A-C40R1DE, FC6A-C40R4DE	7 modules + 8 modules* ¹	
	FC6A-C40K1DE, FC6A-C40K4DE		
	FC6A-C40P1DE, FC6A-C40P4DE		
	FC6A-C40R1AEJ, FC6A-C40R4AEJ		
	FC6A-C40R1CEJ, FC6A-C40R4CEJ		
FC6A-C40K1CEJ, FC6A-C40K4CEJ			
FC6A-C40P1CEJ, FC6A-C40P4CEJ			
FC6A-C40R1DEJ, FC6A-C40R4DEJ			
FC6A-C40K1DEJ, FC6A-C40K4DEJ			
FC6A-C40P1DEJ, FC6A-C40P4DEJ			
Plus CPU module	CAN J1939 All-in-One CPU module	FC6A-D16R1CEE	63 modules* ²
		FC6A-D16R4CEE	
		FC6A-D16K1CEE	
		FC6A-D16K4CEE	
		FC6A-D16P1CEE	
		FC6A-D16P4CEE	
		FC6A-D32K3CEE	
		FC6A-D32K4CEE	
		FC6A-D32P3CEE	
		FC6A-D32P4CEE	

*1 When the expansion interface module (expander) is used, eight analog I/O modules can be connected to the right side of the expansion interface module (expander). The number of modules that can be connected does not include the expansion interface module (expander).

*2 A maximum of 63 analog I/O modules can be connected using expansion interface modules (expander and remote master/slave). The number of modules that can be connected does not include the expansion interface module.

Checking the Hardware Version Number

The analog I/O module hardware version number is printed on the side of the analog I/O module. The performance and functionality of the analog I/O module will differ by its version, so check the version number before use.

S/N:XXXXX-XXXXX
 IDEC CORPORATION

V100

Version Number

Precautions When Using the Product

Do not use an analog I/O module with hardware version number V200 in combination with the system software for analog I/O modules version 1.01 or lower. The operation mode of the analog I/O module will be indefinite and analog input values cannot be acquired correctly.

System software version 1.02 is written to V200 analog I/O modules when they are shipped from the factory. Do not download system software version 1.00 or 1.01 to these analog I/O modules.

If system software version 1.01 or lower is written to a V200 analog I/O module, download the system software for analog I/O modules version 1.02 included with WindLDR Ver. 8.6.1 or higher to the analog I/O module again.

Hardware Version Number	System Software Version	
	Version 1.01 or Lower	Version 1.02 or Higher
Lower than V200	Yes	Yes
V200 or Higher	No	Yes

Analog I/O Module Parameter Settings

This section describes the analog I/O module parameter settings.

The parameter settings are configured for each channel. The parameters to configure differ according to the analog I/O module type and I/O type. In Expansion Modules Configuration, configure the parameter settings according to the application.

For detailed configuration methods, see "Module Configuration Editor" on page 12-1.

Analog Input Type

The following parameters are for configuring the analog inputs on the analog input modules and the mixed analog I/O modules.

Yes: Parameters, —: No parameters

No.	Parameter	FC6A-J2C1 FC6A-J2C4	FC6A-J4A1 FC6A-J4A4	FC6A-J8A1 FC6A-J8A4	FC6A-J4CN1 FC6A-J4CN4	FC6A-J4CH1Y FC6A-J4CH4Y	FC6A-J8CU1 FC6A-J8CU4	FC6A-L06A1 FC6A-L06A4	FC6A-L03CN1 FC6A-L03CN4
(1)	Signal Type	Yes	Yes	Yes	Yes	Yes	Yes	Yes	Yes
(2)	Data Type	Yes	Yes	Yes	Yes	Yes	Yes	Yes	Yes
(3)	Minimum and maximum values (Data type)	Yes	Yes	Yes	Yes	Yes	Yes	Yes	Yes
(4)	Filter	Yes	Yes	Yes	Yes	Yes	Yes	Yes	Yes
(5)	Sample Time	Yes	Yes	Yes	Yes	Yes	Yes	Yes	Yes
(6)	Thermistor Settings	—	—	—	—	—	Yes	—	—
(7)	Data	Yes	Yes	Yes	Yes	Yes	Yes	Yes	Yes
(8)	Status	Yes	Yes	Yes	Yes	Yes	Yes	Yes	Yes

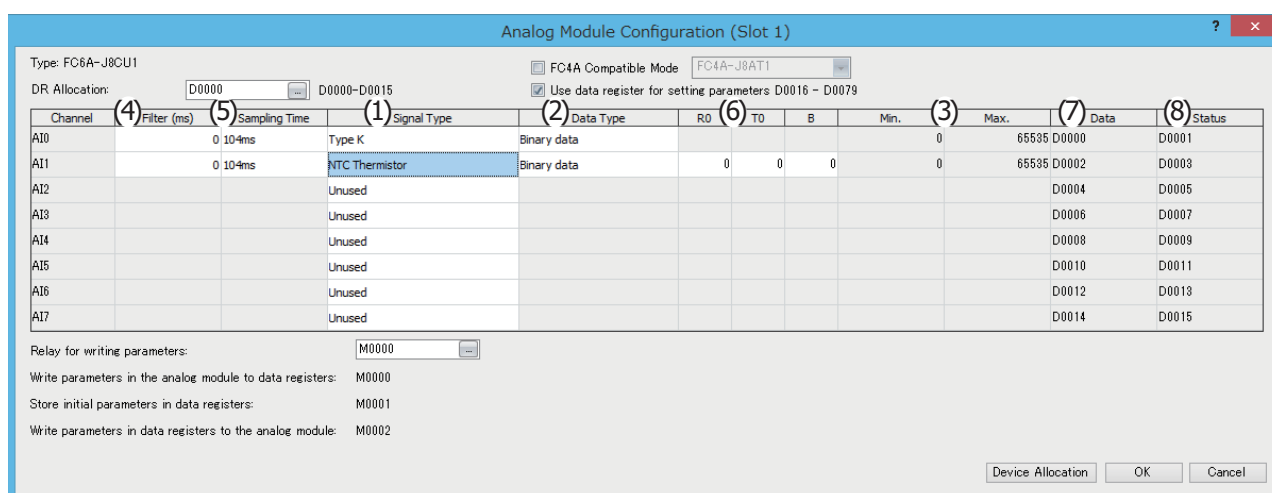

(1) Signal Type

The signal type that can be set differs according to the analog I/O module model. Select the analog I/O module that corresponds to the user application and set the signal type. The signal type is the type of analog input to measure. There are 24 signal types for the analog inputs, which are detailed as follows.

Yes: Supported, —: Not supported

Signal Type	FC6A-J2C1 FC6A-J2C4	FC6A-J4A1 FC6A-J4A4	FC6A-J8A1 FC6A-J8A4	FC6A-J4CN1 FC6A-J4CN4	FC6A-J4CH1Y FC6A-J4CH4Y	FC6A-J8CU1 FC6A-J8CU4	FC6A-L06A1 FC6A-L06A4	FC6A-L03CN1 FC6A-L03CN4
Unused*1	Yes	Yes	Yes	Yes	Yes	Yes	Yes	Yes
0 to 10 V	Yes	Yes	Yes	Yes	—	—	Yes	Yes
-10 to +10 V	Yes	Yes	Yes	Yes	—	—	Yes	Yes
0 to 20 mA	Yes	Yes	Yes	Yes	—	—	Yes	Yes
4 to 20 mA	Yes	Yes	Yes	Yes	—	—	Yes	Yes
Type K thermocouple	—	—	—	Yes	Yes	Yes	—	Yes
Type J thermocouple	—	—	—	Yes	Yes	Yes	—	Yes
Type R thermocouple	—	—	—	Yes	Yes	Yes	—	Yes
Type S thermocouple	—	—	—	Yes	Yes	Yes	—	Yes
Type B thermocouple	—	—	—	Yes	Yes	Yes	—	Yes
Type E thermocouple	—	—	—	Yes	Yes	Yes	—	Yes
Type T thermocouple	—	—	—	Yes	Yes	Yes	—	Yes
Type N thermocouple	—	—	—	Yes	Yes	Yes	—	Yes
Type C thermocouple	—	—	—	Yes	Yes	Yes	—	Yes
Pt100	—	—	—	Yes	—	—	—	Yes
Pt1000	—	—	—	Yes	—	—	—	Yes
Ni100	—	—	—	Yes	—	—	—	Yes
Ni1000	—	—	—	Yes	—	—	—	Yes
NTC thermistor	—	—	—	—	—	Yes	—	—
PTC thermistor	—	—	—	—	—	Yes	—	—
PTC thermistor (threshold)*2	—	—	—	—	—	Yes	—	—
Resistance measurement	—	—	—	—	—	Yes	—	—
Expansion 0 to 20 mA	—	—	Yes	—	—	—	—	—
Expansion 4 to 20 mA	—	—	Yes	—	—	—	—	—

*1 Channels that are set to unused are not scanned.

The circuit is setup the same as when signal type: 0 to 10 V is selected.

0 is always stored in the analog data storage data registers for channels that are set to unused.

*2 For details on PTC thermistor (threshold), see "PTC Thermistor (Threshold)" on page 9-10.

9: ANALOG I/O MODULES

(2) Data Type

The analog input value can be handled as the set data type. There are seven data types for the analog inputs.

Yes: Supported, —: Not supported

Data Type	FC6A-J2C1	FC6A-J4A1	FC6A-J8A1	FC6A-J4CN1	FC6A-J4CH1Y	FC6A-J8CU1	FC6A-L06A1	FC6A-L03CN1
	FC6A-J2C4	FC6A-J4A4	FC6A-J8A4	FC6A-J4CN4	FC6A-J4CH4Y	FC6A-J8CU4	FC6A-L06A4	FC6A-L03CN4
Binary data ^{*1}	Yes	Yes	Yes	Yes	Yes	Yes	Yes	Yes
Optional range ^{*1}	Yes	Yes	Yes	Yes	Yes	Yes	Yes	Yes
Celsius ^{*2}	—	—	—	Yes	Yes	Yes	—	Yes
Fahrenheit ^{*2}	—	—	—	Yes	Yes	Yes	—	Yes
Resistance ^{*3}	—	—	—	—	—	Yes	—	—
Binary data (16 bits)	—	—	Yes ^{*4}	—	—	—	—	—
Optional range (16 bits)	—	—	Yes ^{*4}	—	—	—	—	—

*1 For only the FC6A-J8A1 and FC6A-J8A4, binary data (12 bits) and optional range (12 bits) are displayed.

*2 Can only be set when the signal type is thermocouple, resistance thermometer or NTC thermistor.

*3 Resistance when using the FC6A-J8CU1/FC6A-J8CU4 and the signal type is set to PTC thermistor or Resistance measurement.

*4 Binary data (16 bits) and optional range (16 bits) can be used with the following versions.

FC6A-J8A1, FC6A-J8A4: Version 200 or later

WindLDR: Version 8.6.0 or later

If an FC6A-J8A1 or FC6A-J8A4 that does not correspond to the above version numbers is set to binary data (16 bits) or optional range (16 bits), an error will occur and the module will operate as binary data (12 bits).

(3) Minimum and maximum values

The minimum and maximum values are determined by the set signal type (1) and data type (2).

The value is stored in the data (7) according to the minimum and maximum values.

The minimum and maximum values that correspond to the signal type and data types are as follows.

Signal Type	Data Type						
	Binary Data (12 Bits) ^{*1}	Optional Range (12 Bits) ^{*1*2}	Celsius	Fahrenheit	Resistance	Binary Data (16 Bits)	Optional Range (16 Bits)
0 to 10 V	0 to 65,535	-32,768 to 32,767	—	—	—	0 to 65,535	-32,768 to 32,767
-10 to +10 V	-32,768 to 32,767	-32,768 to 32,767	—	—	—	-32,768 to 32,767	-32,768 to 32,767
0 to 20 mA	0 to 65,535	-32,768 to 32,767	—	—	—	0 to 65,535	-32,768 to 32,767
4 to 20 mA	0 to 65,535	-32,768 to 32,767	—	—	—	0 to 65,535	-32,768 to 32,767
Type K thermocouple	0 to 65,535	-32,768 to 32,767	-2,000 to 13,000	-3,280 to 23,720	—	—	—
Type J thermocouple	0 to 65,535	-32,768 to 32,767	-2,000 to 10,000	-3,280 to 18,320	—	—	—
Type R thermocouple	0 to 65,535	-32,768 to 32,767	0 to 17,600	320 to 32,000	—	—	—
Type S thermocouple	0 to 65,535	-32,768 to 32,767	0 to 17,600	320 to 32,000	—	—	—
Type B thermocouple	0 to 65,535	-32,768 to 32,767	0 to 18,200	320 to 33,080	—	—	—
Type E thermocouple	0 to 65,535	-32,768 to 32,767	-2,000 to 8,000	-3,280 to 14,720	—	—	—
Type T thermocouple	0 to 65,535	-32,768 to 32,767	-2,000 to 4,000	-3,280 to 7,520	—	—	—
Type N thermocouple	0 to 65,535	-32,768 to 32,767	-2,000 to 13,000	-3,280 to 23,720	—	—	—
Type C thermocouple	0 to 65,535	-32,768 to 32,767	0 to 23,150	320 to 41,990	—	—	—
Pt100	0 to 65,535	-32,768 to 32,767	-2,000 to 8,500	-3,280 to 15,620	—	—	—
Pt1000	0 to 65,535	-32,768 to 32,767	-2,000 to 6,000	-3,280 to 11,120	—	—	—
Ni100	0 to 65,535	-32,768 to 32,767	-600 to 1,800	-760 to 3,560	—	—	—
Ni1000	0 to 65,535	-32,768 to 32,767	-600 to 1,800	-760 to 3,560	—	—	—
NTC thermistor	0 to 65,535	-32,768 to 32,767	-900 to 1,500	-1,300 to 3,020	—	—	—
PTC thermistor	0 to 65,535	-32,768 to 32,767	—	—	100 to 10,000	—	—
PTC thermistor (threshold) ^{*3}	100 to 10,000	100 to 10,000	—	—	—	—	—
Resistance measurement	0 to 65,535	-32,768 to 32,767	—	—	100 to 32,000	—	—
Expansion 0 to 20 mA	0 to 4,095	-32,768 to 32,767	—	—	—	0 to 65,535	-32,768 to 32,767
Expansion 4 to 20 mA	0 to 4,095	-32,768 to 32,767	—	—	—	0 to 65,535	-32,768 to 32,767

*1 For only the FC6A-J8A1 and FC6A-J8A4, binary data (12 bits) and optional range (12 bits).

*2 The minimum and maximum values can be set only when the data type is set to optional range. Set the minimum and maximum values between -32,768 and 32,767. However, when the signal type is set to PTC thermistor (threshold), set the minimum and maximum values between 100 and 10,000. For the arbitrary setting, see ^{*4} in Chapter 2 "Product Specifications" on page 2-90.

*3 For details on PTC thermistor (threshold), see "PTC Thermistor (Threshold)" on page 9-10.

(4) Filter

The analog input is filtered so it reaches approximately 99% of the analog input in the set time. Rapid fluctuations in the analog input can be reduced by setting the filter, but increasing the filter slows down the tracking of fluctuations in the analog input. The filter must be set for each channel.

Input filter example

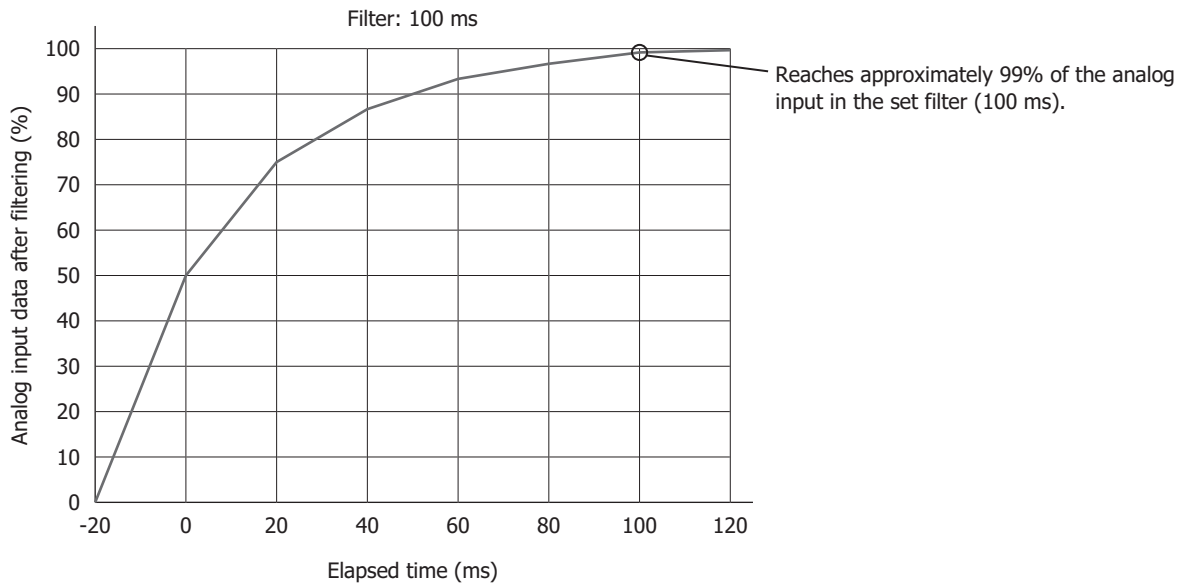

Filter (ms)	Description
0	The value is not filtered.
50 to 50,000	The analog input filter can be set in 50 ms increments. The analog input is filtered so that approximately 99% of the analog input is reached in the specified filter.

(5) Sampling Time

Analog values are converted to digital values at the interval of the sampling time. Depending on the analog I/O module, you may be able to change the sampling time setting.

Type	Signal Type	Sample Time
FC6A-J2C1 FC6A-J2C4	0 to 10 V	1 ms
	-10 to +10 V	1 ms
	0 to 20 mA	1 ms
	4 to 20 mA	1 ms
FC6A-J4A1 FC6A-J4A4	0 to 10 V	1 ms/10 ms
	-10 to +10 V	1 ms/10 ms
	0 to 20 mA	1 ms/10 ms
	4 to 20 mA	1 ms/10 ms
FC6A-J8A1 FC6A-J8A4	0 to 10 V	1 ms/10 ms
	-10 to +10 V	1 ms/10 ms
	0 to 20 mA	1 ms/10 ms
	4 to 20 mA	1 ms/10 ms
	Expansion 0 to 20 mA	1 ms/10 ms
	Expansion 4 to 20 mA	1 ms/10 ms
FC6A-J4CN1 FC6A-J4CN4	0 to 10 V	100 ms/10 ms
	-10 to +10 V	100 ms/10 ms
	0 to 20 mA	100 ms/10 ms
	4 to 20 mA	100 ms/10 ms
	Thermocouple	104 ms
	Resistance thermometer	104 ms
FC6A-J4CH1Y FC6A-J4CH4Y	Thermocouple	120 ms/30 ms*1
	Thermocouple	104 ms
FC6A-J8CU1 FC6A-J8CU4	NTC/PTC thermistor	104 ms
	PTC thermistor (threshold)	104 ms
	Resistance measurement	104 ms
	Resistance measurement	104 ms
FC6A-L06A1 FC6A-L06A4	0 to 10 V	1 ms/10 ms
	-10 to +10 V	1 ms/10 ms
	0 to 20 mA	1 ms/10 ms
	4 to 20 mA	1 ms/10 ms
FC6A-L03CN1 FC6A-L03CN4	0 to 10 V	100 ms/10 ms
	-10 to +10 V	100 ms/10 ms
	0 to 20 mA	100 ms/10 ms
	4 to 20 mA	100 ms/10 ms
	Thermocouple	104 ms
	Resistance thermometer	104 ms

*1 When the sampling time is set to 30 ms, the modules may be more easily affected by commercial power supply noise (50/60 Hz noise) and fluctuations in input values may become larger. If there are large fluctuations in input values, change the sampling time to 120 ms.

(6) Thermistor settings

When NTC thermistor is selected for the FC6A-J8CU1/FC6A-J8CU4 signal type, the following parameters must be set.

Parameter	Description	Range
R0	The thermistor resistance in "T0"°C (Ω)*1	0 to 65,535
T0	Temperature (°C)*1	-32,768 to 32,767
B	Thermistor B constant*1	-32,768 to 32,767

*1 Information are described in the instruction sheet for the thermistor to use.

The characteristic of NTC thermistor is that the resistance decreases as the temperature rises. The analog modules measure the resistance of the thermistor and calculate the temperature based on above three parameters.

The measurable range of the resistance of NTC thermistor is 100 Ω to 200,000 Ω . The range of temperature that can be calculated is -90°C to 150°C. Select NTC thermistor that functions within those ranges.

(7) Data

Data refers to the input analog values converted to digital values at the interval of the sampling time.

The data is written to data registers in the END processing of each scan. The analog input data is updated regardless of whether the FC6A Series MICROSmart is stopped or running. The data is not guaranteed when the status (8) is a value other than "0".

For details on when PTC thermistor (threshold) is selected for the signal type, see "PTC Thermistor (Threshold)" on page 9-10.

(8) Status

The status of the analog input data (7) is stored in data registers.

Status	Description
0	Operating normally
1	Converting data
2	Initializing
3	Parameter setting error
4	Hardware fault (external power supply error)
5	Wiring fault (out of maximum range) ^{*1}
6	Wiring fault (out of minimum range) ^{*1}
7	Reserved
8	When the analog input value is greater than 20 mA and less than the upper limit value ^{*2}
9	When the analog input value is greater than the lower limit value and less than 4 mA ^{*3}
10 to 65,535	Reserved

*1 When the analog input value is the upper limit value in the below table or higher, the out of maximum range error occurs. When the analog input value is the lower limit value in the below table or lower, the out of minimum range error occurs.

Signal Type	Lower Limit Value	Upper Limit Value
0 to 10 V	-0.2 V	10.2 V
-10 to +10 V	-10.4 V	10.4 V
0 to 20 mA	-0.4 mA	20.4 mA
4 to 20 mA	3.68 mA	20.32 mA
Type K thermocouple	-200.0°C	1,300.0°C
Type J thermocouple	-200.0°C	1,000.0°C
Type R thermocouple	0.0°C	1,760.0°C
Type S thermocouple	0.0°C	1,760.0°C
Type B thermocouple	0.0°C	1,820.0°C
Type E thermocouple	-200.0°C	800.0°C
Type T thermocouple	-200.0°C	400.0°C
Type N thermocouple	-200.0°C	1,300.0°C
Type C thermocouple	0.0°C	2,315.0°C
Pt100	-200.0°C	850.0°C
Pt1000	-200.0°C	600.0°C
Ni100	-60.0°C	180.0°C
Ni1000	-60.0°C	180.0°C
NTC thermistor	-90.0°C or 200 kΩ ^{*4}	150.0°C or 100 Ω ^{*5}
PTC thermistor	100 Ω	10 kΩ
PTC thermistor (threshold)	100 Ω	10 kΩ
Resistance measurement	100 Ω	32 kΩ
Expansion 0 to 20 mA	-0.4 mA	23.54 mA
Expansion 4 to 20 mA	1.20 mA	23.17 mA

*2 Expansion 0 to 20 mA or expansion 4 to 20 mA only

*3 Expansion 4 to 20 mA only

*4 Out of minimum range error occurs when a resistance of 200 kΩ or higher is connected.

*5 Out of maximum range error occurs when a resistance of 100 Ω or lower is connected.

PTC Thermistor (Threshold)

This section describes details on PTC thermistor (threshold).

The value is stored in the data (7) according to the resistance of the PTC thermistor and the minimum and maximum values (3).

The relationship between the resistance of the PTC thermistor, the minimum and maximum values (3), and the data (7) is as follows.

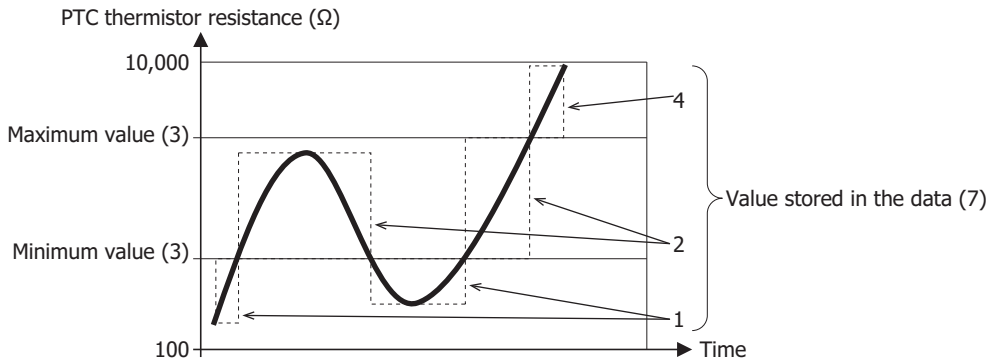

- Value stored in the data (7): 1 Minimum value (3) > PTC thermistor resistance
- Value stored in the data (7): 2 Minimum value (3) ≤ PTC thermistor resistance ≤ Maximum value (3)
- Value stored in the data (7): 4 Maximum value (3) < PTC thermistor resistance

For the operation when the resistance of the PTC thermistor matches the minimum or maximum value, see "Hysteresis" below.

Hysteresis

The system has a hysteresis of ±20 Ω for the minimum and maximum values that are set (3). For example, if the minimum value is set to 1,500 and the maximum value is set to 7,000, the operation is shown as follows.

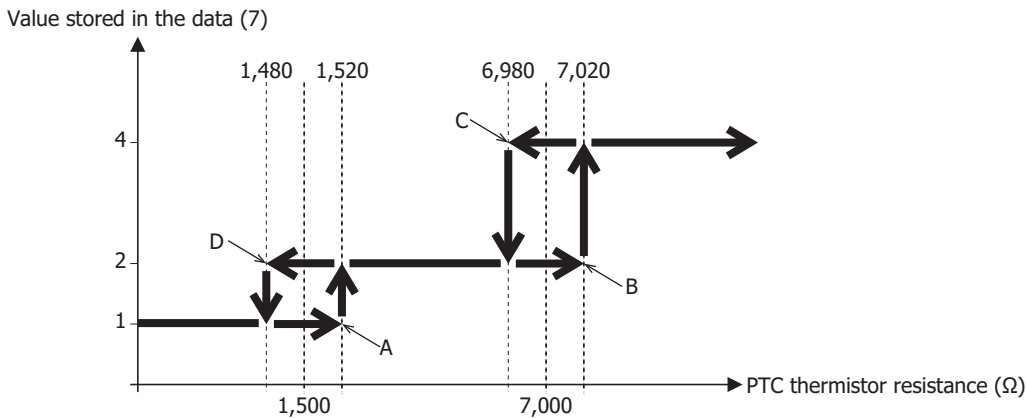

- A: The value of the data (7) changes from 1 to 2 when the resistance of the PTC thermistor is greater than or equal to 1,520 Ω
- B: The value of the data (7) changes from 2 to 4 when the resistance of the PTC thermistor exceeds 7,020 Ω
- C: The value of the data (7) changes from 4 to 2 when the resistance of the PTC thermistor is less than or equal to 6,980 Ω
- D: The value of the data (7) changes from 2 to 1 when the resistance of the PTC thermistor is less than 1,480 Ω

Note: When setting the minimum and maximum values (3), ensure that the difference between the two values is 41 or greater. If the difference between the minimum and maximum values (3) is less than or equal to 40, status 3 (parameter setting error) is stored in the status (8).

Behavior of the Status

If the resistance of the PTC thermistor is out of range, the following values are stored in status (8).

If the resistance of the PTC thermistor is less than 100 Ω, status 6 (wiring fault (out of minimum range)) is stored in status (8).

If the resistance of the PTC thermistor is greater than 10,000 Ω, status 5 (wiring fault (out of maximum range)) is stored in status (8).

Analog Output Type

The following parameters are for configuring the analog outputs on the analog output modules and the mixed analog I/O modules.

Yes: Parameters, —: No parameters

No.	Parameter	FC6A-K2A1 FC6A-K2A4	FC6A-K4A1 FC6A-K4A4	FC6A-L06A1 FC6A-L06A4	FC6A-L03CN1 FC6A-L03CN4
(1)	Signal Type	Yes	Yes	Yes	Yes
(2)	Data Type	Yes	Yes	Yes	Yes
(3)	Minimum and maximum values (Data type)	Yes	Yes	Yes	Yes
(4)	Data	Yes	Yes	Yes	Yes
(5)	Status	Yes	Yes	Yes	Yes

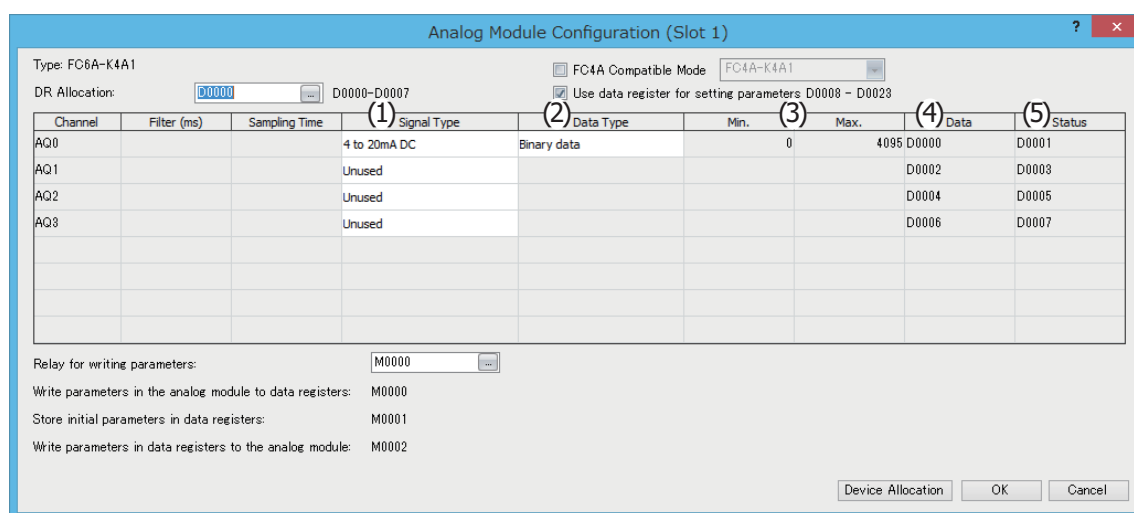

(1) Signal Type

The signal type that can be set differs according to the analog I/O module model. Select the analog I/O module that corresponds to the user application and set the signal type. There are five types of signal types for the analog outputs, which are detailed as follows.

Yes: Supported, -: Not supported

Signal Type	FC6A-K2A1 FC6A-K2A4	FC6A-K4A1 FC6A-K4A4	FC6A-L06A1 FC6A-L06A4	FC6A-L03CN1 FC6A-L03CN4
Unused*1	Yes	Yes	Yes	Yes
0 to 10 V	Yes	Yes	Yes	Yes
-10 to +10 V	Yes	Yes	Yes	Yes
0 to 20 mA	Yes	Yes	Yes	Yes
4 to 20 mA	Yes	Yes	Yes	Yes

*1 Channels that are set to unused are not scanned.
The circuit is setup the same as when signal type: 0 to 10 V is selected.
A channel set to unused always outputs 0 V.

Caution The device connected to the analog I/O module may be damaged if the analog output signal type is mistakenly set and used. Please use caution when setting the analog output signal type.

(2) Data Type

The analog output value can be handled as the set data type. There are two data types for the analog outputs.

Yes: Supported, —: Not supported

Data Type	FC6A-K2A1 FC6A-K2A4	FC6A-K4A1 FC6A-K4A4	FC6A-L06A1 FC6A-L06A4	FC6A-L03CN1 FC6A-L03CN4
Binary data	Yes	Yes	Yes	Yes
Optional range	Yes	Yes	Yes	Yes

(3) Minimum and maximum values

The value written to the data register is output from the analog output. The minimum and maximum values that can be written are determined by the set signal type and data type. A parameter setting error occurs when a value is set that exceeds the minimum or maximum value.

The minimum and maximum values that correspond to the signal types and data types are as follows.

Signal Type	Data Type	
	Binary Data	Optional Range ^{*1}
0 to 10 V	0 to 4,095	-32,768 to 32,767
-10 to +10 V	-2,048 to 2,047	-32,768 to 32,767
0 to 20 mA	0 to 4,095	-32,768 to 32,767
4 to 20 mA	0 to 4,095	-32,768 to 32,767

*1 The minimum and maximum values can be set only when the data type is set to optional range. Set the minimum and maximum values between -32,768 and 32,767.

(4) Data

The analog output data for the analog output set with signal type (1) to minimum and maximum values (3) is stored in the data registers in the END progressing of each scan. The actual analog output data is not guaranteed when the analog output status (5) is a value other than "0". When M8025 (Maintain Outputs While Stopped) is on while stopped, the analog output value immediately before stopping is output. When M8025 is off, the minimum value of the analog output is output. However, 0 V is output when the signal type is -10 V to +10 V.

(5) Status

The status of the analog output data (4) is stored in data registers.

Status	Description
0	Operating normally
1	Reserved
2	Initializing
3	Parameter setting error
4	Hardware fault (external power supply error)
5 to 65,535	Reserved

Control Registers

Data registers are set as the devices to store the parameters for the analog I/O module.

Multiple words are used starting from the set data register. The number of words of data registers that are used differs according to the analog I/O module model and the "Use data register for setting parameters" setting.

"Use Data Register for Setting Parameters"	Used Data Registers (words)									
	FC6A-J2C1	FC6A-J4A1	FC6A-J8A1	FC6A-J4CN1	FC6A-J4CH1Y	FC6A-J8CU1	FC6A-K2A1	FC6A-K4A1	FC6A-L06A1	FC6A-L03CN1
	FC6A-J2C4	FC6A-J4A4	FC6A-J8A4	FC6A-J4CN4	FC6A-J4CH4Y	FC6A-J8CU4	FC6A-K2A4	FC6A-K4A4	FC6A-L06A4	FC6A-L03CN4
Disabled	4	8	16	8	8	16	4	8	12	6
Enabled	14	28	56	28	28	80	12	24	40	20

When "Use data register for setting parameters" is disabled

Only the data and status are stored in control registers.

Note: At the first scan when stop changes to run, the analog I/O module is set with the parameters (initial values) configured in WindLDR. While the parameters are being set, the analog I/O module status is initializing. After the parameters are finished being set, the analog I/O module operates normally.

When "Use data register for setting parameters" is enabled

In addition to the data and status, the operation mode, data type, minimum value, and maximum value are stored in control registers. For analog inputs, the filter value and thermistor settings are also stored.

Notes:

- When the CPU module is switched from stop to run, the analog I/O module is set with the values of the operation setting data registers.
- The parameters (initial values) configured in WindLDR are transferred to the operation setting data registers when the user program is updated or when a keep data sum check error occurs.
- When the "Write operation setting parameters" input changes from off to on, the analog I/O module is set with the content of the operation setting data registers in the END processing of the same scan.
- While the parameters are being set, the analog I/O module status is initializing. After the parameters are finished being set, the analog I/O module operates normally.

Control Relays

When "Use data register for setting parameters" is enabled, internal relays can be set as control relays.

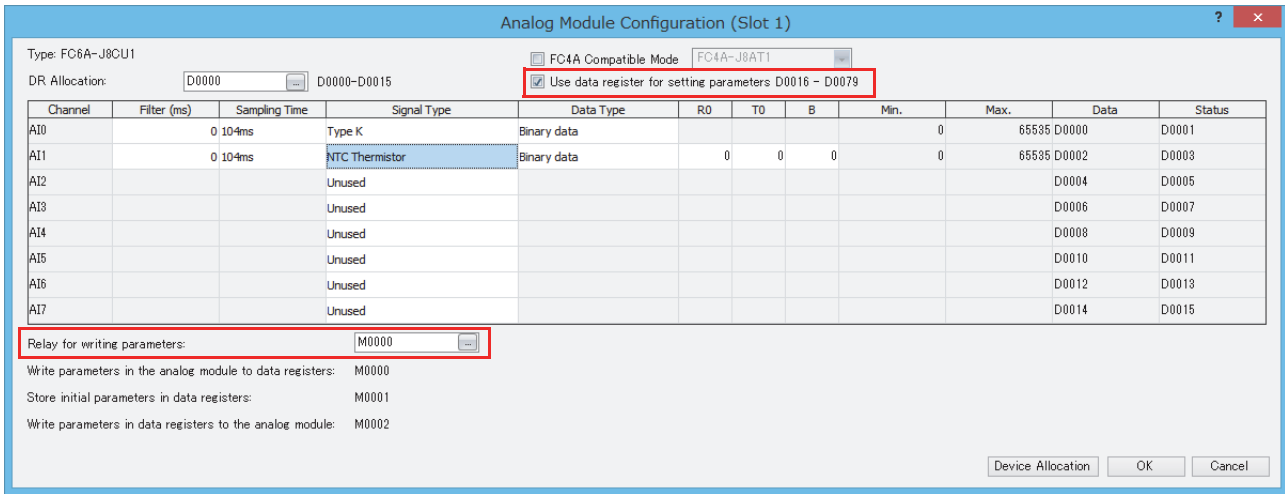

3 bits are used starting from the internal relay that was set, and each bit has the following function.

Position from Starting Bit	Description	R/W
+0	Read parameters (analog I/O module → operation setting data registers)	R/W
+1	Read initial parameter values (WindLDR settings → operation setting data registers)	R/W
+2	Write operation setting parameters (operation setting data registers → analog I/O module)	R/W

Notes:

- Starting internal relay address +0: Read parameters
When changed from off to on, the analog I/O module setting values are read into the operation setting data registers.
- Starting internal relay address +1: Read initial parameter values
When changed from off to on, the initial values (the parameters that were saved when the user program download was executed) are read into the operation setting data registers.
- Starting internal relay address +2: Write operation setting parameters
When changed from off to on, the data stored in the data registers is written to the analog I/O module as the parameters.
- After a control relay is changed from off to on, it automatically turns off.
- If all of the control relays are changed from off to on in the same scan, they are executed in +0, +1, +2 order, and the analog I/O module is set with the initial values.

Device Allocation

This section describes the allocation of analog I/O module devices.

Analog Input Module

The detailed device allocation for analog input modules is as follows.

For the parameter setting values, see "Analog Input Parameter Setting Values" on page 9-17.

Channel		Parameter	R/W	FC6A-J2C1	FC6A-J4A1	FC6A-J8A1	FC6A-J4CN1	FC6A-J4CH1Y	FC6A-J8CU1	
I/O	No.			FC6A-J2C4	FC6A-J4A4	FC6A-J8A4	FC6A-J4CN4	FC6A-J4CH4Y	FC6A-J8CU4	
Input	CH0	Analog input data	R	+0	+0	+0	+0	+0	+0	
		Analog input status	R	+1	+1	+1	+1	+1	+1	
	CH1	Analog input data	R	+2	+2	+2	+2	+2	+2	
		Analog input status	R	+3	+3	+3	+3	+3	+3	
	CH2	Analog input data	R	—	+4	+4	+4	+4	+4	
		Analog input status	R	—	+5	+5	+5	+5	+5	
	CH3	Analog input data	R	—	+6	+6	+6	+6	+6	
		Analog input status	R	—	+7	+7	+7	+7	+7	
	CH4	Analog input data	R	—	—	+8	—	—	+8	
		Analog input status	R	—	—	+9	—	—	+9	
	CH5	Analog input data	R	—	—	+10	—	—	+10	
		Analog input status	R	—	—	+11	—	—	+11	
	CH6	Analog input data	R	—	—	+12	—	—	+12	
		Analog input status	R	—	—	+13	—	—	+13	
	CH7	Analog input data	R	—	—	+14	—	—	+14	
		Analog input status	R	—	—	+15	—	—	+15	
	When use data register for setting parameters, the following data registers are used.									
	Input	CH0	Signal type	R/W	+4	+8	+16	+8	+8	+16
			Data type	R/W	+5	+9	+17	+9	+9	+17
			Minimum value	R/W	+6	+10	+18	+10	+10	+18
Maximum value			R/W	+7	+11	+19	+11	+11	+19	
Filter value			R/W	+8	+12	+20	+12	+12	+20	
Thermistor constant (R0)			R/W	—	—	—	—	—	+21	
Thermistor constant (T0)			R/W	—	—	—	—	—	+22	
Thermistor constant (B)			R/W	—	—	—	—	—	+23	
CH1		Signal type	R/W	+9	+13	+21	+13	+13	+24	
		Data type	R/W	+10	+14	+22	+14	+14	+25	
		Minimum value	R/W	+11	+15	+23	+15	+15	+26	
		Maximum value	R/W	+12	+16	+24	+16	+16	+27	
		Filter value	R/W	+13	+17	+25	+17	+17	+28	
		Thermistor constant (R0)	R/W	—	—	—	—	—	+29	
		Thermistor constant (T0)	R/W	—	—	—	—	—	+30	
		Thermistor constant (B)	R/W	—	—	—	—	—	+31	
CH2		Signal type	R/W	—	+18	+26	+18	+18	+32	
		Data type	R/W	—	+19	+27	+19	+19	+33	
		Minimum value	R/W	—	+20	+28	+20	+20	+34	
		Maximum value	R/W	—	+21	+29	+21	+21	+35	
	Filter value	R/W	—	+22	+30	+22	+22	+36		
	Thermistor constant (R0)	R/W	—	—	—	—	—	+37		
	Thermistor constant (T0)	R/W	—	—	—	—	—	+38		
	Thermistor constant (B)	R/W	—	—	—	—	—	+39		

9: ANALOG I/O MODULES

Channel		Parameter	R/W	FC6A-J2C1	FC6A-J4A1	FC6A-J8A1	FC6A-J4CN1	FC6A-J4CH1Y	FC6A-J8CU1
I/O	No.			FC6A-J2C4	FC6A-J4A4	FC6A-J8A4	FC6A-J4CN4	FC6A-J4CH4Y	FC6A-J8CU4
Input	CH3	Signal type	R/W	—	+23	+31	+23	+23	+40
		Data type	R/W	—	+24	+32	+24	+24	+41
		Minimum value	R/W	—	+25	+33	+25	+25	+42
		Maximum value	R/W	—	+26	+34	+26	+26	+43
		Filter value	R/W	—	+27	+35	+27	+27	+44
		Thermistor constant (R0)	R/W	—	—	—	—	—	+45
		Thermistor constant (T0)	R/W	—	—	—	—	—	+46
		Thermistor constant (B)	R/W	—	—	—	—	—	+47
	CH4	Signal type	R/W	—	—	+36	—	—	+48
		Data type	R/W	—	—	+37	—	—	+49
		Minimum value	R/W	—	—	+38	—	—	+50
		Maximum value	R/W	—	—	+39	—	—	+51
		Filter Value	R/W	—	—	+40	—	—	+52
		Thermistor constant (R0)	R/W	—	—	—	—	—	+53
		Thermistor constant (T0)	R/W	—	—	—	—	—	+54
		Thermistor constant (B)	R/W	—	—	—	—	—	+55
	CH5	Signal type	R/W	—	—	+41	—	—	+56
		Data type	R/W	—	—	+42	—	—	+57
		Minimum value	R/W	—	—	+43	—	—	+58
		Maximum value	R/W	—	—	+44	—	—	+59
		Filter value	R/W	—	—	+45	—	—	+60
		Thermistor constant (R0)	R/W	—	—	—	—	—	+61
		Thermistor constant (T0)	R/W	—	—	—	—	—	+62
		Thermistor constant (B)	R/W	—	—	—	—	—	+63
	CH6	Signal type	R/W	—	—	+46	—	—	+64
		Data type	R/W	—	—	+47	—	—	+65
		Minimum value	R/W	—	—	+48	—	—	+66
		Maximum value	R/W	—	—	+49	—	—	+67
Filter Value		R/W	—	—	+50	—	—	+68	
Thermistor constant (R0)		R/W	—	—	—	—	—	+69	
Thermistor constant (T0)		R/W	—	—	—	—	—	+70	
Thermistor constant (B)		R/W	—	—	—	—	—	+71	
CH7	Signal type	R/W	—	—	+51	—	—	+72	
	Data type	R/W	—	—	+52	—	—	+73	
	Minimum value	R/W	—	—	+53	—	—	+74	
	Maximum value	R/W	—	—	+54	—	—	+75	
	Filter value	R/W	—	—	+55	—	—	+76	
	Thermistor constant (R0)	R/W	—	—	—	—	—	+77	
	Thermistor constant (T0)	R/W	—	—	—	—	—	+78	
	Thermistor constant (B)	R/W	—	—	—	—	—	+79	

Analog Input Parameter Setting Values

The parameter setting values are as follows.

Signal type

Setting Value	Signal Type
0	Unused
1	0 to 10 V
2	-10 to +10 V
3	0 to 20 mA
4	4 to 20 mA
5	Type K thermocouple
6	Type J thermocouple
7	Type R thermocouple
8	Type S thermocouple
9	Type B thermocouple
10	Type E thermocouple
11	Type T thermocouple
12	Type N thermocouple
13	Type C thermocouple
14	Pt100
15	Pt1000
16	Ni100
17	Ni1000
18	NTC thermistor
19	PTC thermistor
20	PTC thermistor (threshold)
21	Resistance measurement
22	Expansion 0 to 20 mA
23	Expansion 4 to 20 mA

If the setting value is outside the range, a parameter setting error will occur.

Data type

Setting Value	Data type
0	Binary data/Binary data (12 bits)
1	Optional range/Optional range (12 bits)
2	Celsius/resistance/Binary data (16 bits)
3	Fahrenheit/Optional range (16 bits)

If the setting value is 4 to 65,535, a parameter setting error will occur.

Minimum and maximum values

The minimum and maximum values can be set only when the data type is set to optional range. Set the minimum and maximum values between -32,768 and 32,767. However, when the signal type is set to PTC thermistor (threshold), set the minimum and maximum values between 100 and 10,000.

9: ANALOG I/O MODULES

Filter

Setting Value	Filter
0	0 ms
50	50 ms
100	100 ms
150	150 ms
...	...
50,000	50,000 ms

The setting value is rounded by 50.

When 50,001 to 65,535 is stored for the setting value, the filter operates as the maximum value of 50,000 ms.

Thermistor constant

Range	Thermistor Constant
0 to 65,535	R0
-32,768 to 32,767	T0
-32,768 to 32,767	B

Analog Output Module

The detailed device allocation for analog output modules is as follows.

For the parameter setting values, see "Analog Output Parameter Setting Values" on page 9-19.

Channel		Parameter	R/W	FC6A-K2A1 FC6A-K2A4	FC6A-K4A1 FC6A-K4A4	
I/O	No.					
Output	CH0	Analog output data	R	+0	+0	
		Analog output status	R	+1	+1	
	CH1	Analog output data	R	+2	+2	
		Analog output status	R	+3	+3	
	CH2	Analog output data	R	—	+4	
		Analog output status	R	—	+5	
	CH3	Analog output data	R	—	+6	
		Analog output status	R	—	+7	
	When use the operation setting data registers, the following data registers are used.					
	CH0	Signal type	R/W	+4	+8	
		Data type	R/W	+5	+9	
		Minimum value	R/W	+6	+10	
		Maximum value	R/W	+7	+11	
	CH1	Signal type	R/W	+8	+12	
		Data type	R/W	+9	+13	
		Minimum value	R/W	+10	+14	
		Maximum value	R/W	+11	+15	
	CH2	Signal type	R/W	—	+16	
		Data type	R/W	—	+17	
		Minimum value	R/W	—	+18	
Maximum value		R/W	—	+19		
CH3	Signal type	R/W	—	+20		
	Data type	R/W	—	+21		
	Minimum value	R/W	—	+22		
	Maximum value	R/W	—	+23		

Analog Output Parameter Setting Values

The parameter setting values are as follows.

Signal type

Setting Value	Signal Type
0	Unused
1	0 to 10 V
2	-10 to +10 V
3	0 to 20 mA
4	4 to 20 mA

If the setting value is outside the range, a parameter setting error will occur.

Data type

Setting Value	Data type
0	Binary data
1	Optional range

If the setting value is 2 to 65,535, a parameter setting error will occur.

Minimum and maximum values

The minimum and maximum values can be set only when the data type is set to optional range. Set the minimum and maximum values between -32,768 and 32,767.

Mixed Analog I/O Module

The detailed device allocation for mixed analog I/O modules is as follows. For the parameter setting values for analog inputs, see "Analog Input Parameter Setting Values" on page 9-17. For analog outputs, see "Analog Output Parameter Setting Values" on page 9-19.

Channel No.	Parameter	R/W	FC6A-L06A1 FC6A-L06A4		FC6A-L03CN1 FC6A-L03CN4		
			I/O		I/O		
CH0	Analog data	R	Input	+0	Input	+0	
	Analog status	R		+1		+1	
CH1	Analog data	R		+2		+2	
	Analog status	R		+3	+3		
CH2	Analog data	R		+4	Output	+4	
	Analog status	R		+5		+5	
CH3	Analog data	R		+6	—	—	
	Analog status	R		+7	—	—	
CH4	Analog data	R		Output	+8	—	—
	Analog status	R			+9	—	—
CH5	Analog data	R			+10	—	—
	Analog status	R	+11		—	—	

When use the operation setting data registers, the following data registers are used.

CH0	Signal type	R/W	Input	+12	Input	+6
	Data type	R/W		+13		+7
	Minimum value	R/W		+14		+8
	Maximum value	R/W		+15		+9
	Filter value	R/W		+16		+10
CH1	Signal type	R/W		+17	+11	
	Data type	R/W		+18	+12	
	Minimum value	R/W		+19	+13	
	Maximum value	R/W		+20	+14	
	Filter value	R/W		+21	+15	
CH2	Signal type	R/W		+22	Output	+16
	Data type	R/W		+23		+17
	Minimum value	R/W		+24		+18
	Maximum value	R/W		+25		+19
	Filter value	R/W		+26		—
CH3	Signal type	R/W	+27	—	—	
	Data type	R/W	+28	—	—	
	Minimum value	R/W	+29	—	—	
	Maximum value	R/W	+30	—	—	
	Filter value	R/W	+31	—	—	
CH4	Signal type	R/W	Output	+32	—	—
	Data type	R/W		+33	—	—
	Minimum value	R/W		+34	—	—
	Maximum value	R/W		+35	—	—
	Filter value	R/W		—	—	—
CH5	Signal type	R/W		+36	—	—
	Data type	R/W		+37	—	—
	Minimum value	R/W		+38	—	—
	Maximum value	R/W		+39	—	—
	Filter value	R/W		—	—	—

FC4A compatibility mode

If FC4A Compatible Mode is enabled, device allocations, such as those for data and statuses, can be set to be compatible with the specified FC4A analog module.

Analog Module Configuration (Slot 1)

Type: FC6A-J8CU1

DR Allocation: D0000

FC4A Compatible Mode

FC4A-J8AT1

Use data register for setting parameters

Channel	Filter (ms)	Sampling Time	Signal Type	Data Type	R0	T0	B	Min.	Max.	Data	Status
A10		0.104ms	Type K	Binary data				0	65535	D0046	D0054
A11		0.104ms	NTC Thermistor	Binary data	0	0	0	0	65535	D0047	D0055
A12			Unused							D0048	D0056
A13			Unused							D0049	D0057
A14			Unused							D0050	D0058
A15			Unused							D0051	D0059
A16			Unused							D0052	D0060
A17			Unused							D0053	D0061

Relay for writing parameters: M0000

Write parameters in the analog module to data registers: M0000

Store initial parameters in data registers: M0001

Write parameters in data registers to the analog module: M0002

Device Allocation OK Cancel

FC4A Compatible Mode is automatically enabled if the model setting is changed to FC6A in a ladder program that uses an FC4A analog module.

10: I/O CARTRIDGES

This chapter provides an overview of the cartridge slot, as well as an overview of I/O cartridges and their specifications, parameters, and configuration methods.

Digital I/O Cartridge

Digital I/O Cartridge Overview

This section provides an overview of digital I/O cartridges and describes the compatible cartridge slots.

Digital I/O cartridges are used to expand the digital inputs or digital outputs. Digital I/O cartridges are available in two types of cartridges: digital input cartridges equipped with input terminals and digital output cartridges equipped with output terminals.

To use a digital I/O cartridge, it must be configured in the Module Configuration Editor. For detailed configuration methods, see "Module Configuration Editor" on page 12-1. For details on digital I/O cartridge parameters, see "Digital I/O Cartridge Parameters" on page 10-4.

Cartridge Slots

All-in-One CPU module/CAN J1939 All-in-One CPU module

The All-in-One CPU module/CAN J1939 All-in-One CPU module are equipped with a maximum of two cartridge slots for connecting cartridges. These can be used to connect up to two cartridges. Furthermore, the FC6A Series MICROSmart can be expanded with a maximum of eight digital inputs or digital outputs by connecting the HMI module to the left side of the All-in-One CPU module/CAN J1939 All-in-One CPU module and connecting one digital I/O cartridge.

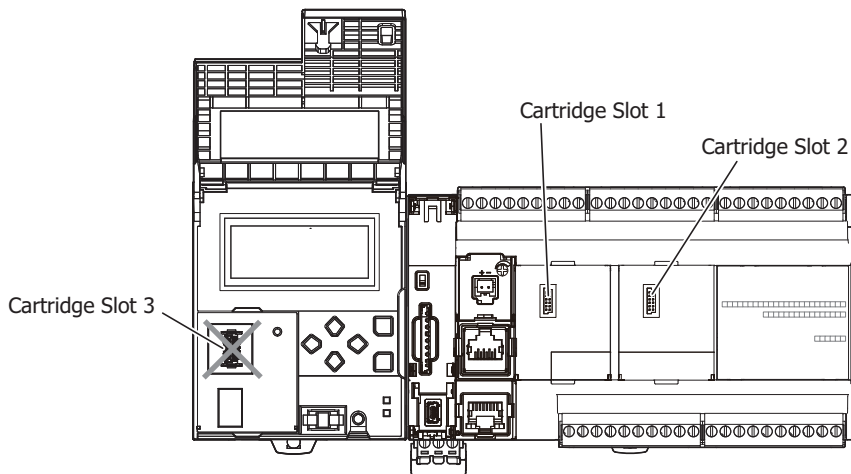

CPU Module		Cartridge Slot 1	Cartridge Slot 2	HMI Module Cartridge Slot 3
All-in-One CPU module	16-I/O type	Yes	—	Yes ^{*1}
	24-I/O type	Yes	—	Yes ^{*1}
	40-I/O type	Yes	Yes	Yes ^{*1}
CAN J1939 All-in-One CPU module		Yes	Yes	Yes ^{*1}

*1 For the All-in-One CPU module/CAN J1939 All-in-One CPU module, the maximum I/O refresh time of the digital I/O cartridge connected to cartridge slot 3 is calculated with the following calculation.

$$\text{Maximum I/O refresh time} = 90 \text{ ms} + (\text{number of connections being used} \times 30 \text{ ms}) + \text{input filter settings} + \text{scan time of one scan}$$

For details on the number of connections being used, see "Connection Settings" on page 7-48.

For details on the input filter settings, see "Digital I/O Cartridge Parameters" on page 10-4. The input filter settings item is used only for a digital input cartridge.

Select the digital I/O cartridges for the connected devices and configure the signal types.

10: I/O CARTRIDGES

Notes:

- Always install and remove the digital I/O cartridges in the FC6A Series MICROSmart when the power is turned off. If a digital I/O cartridge is installed in or removed from the FC6A Series MICROSmart when the power is on, the product may be damaged. There is also a risk that the digital I/O cartridge may not operate correctly.
- The digital I/O cartridge may be damaged when dropped, so take great care not to drop it when removing it.
- Correctly connect the digital I/O cartridges to the cartridge slots.
- For details on how to install and remove the digital I/O cartridges, see "Assembling the CPU Module and a Cartridge" on page 3-6.

Plus CPU module

To use digital I/O cartridges with the Plus CPU module, connect a cartridge base module or the HMI module to the Plus CPU module. These can be used to connect up to three digital I/O cartridges.

Digital inputs or digital outputs can be increased to a maximum of 12 points by installing digital I/O cartridges in the cartridge slots.

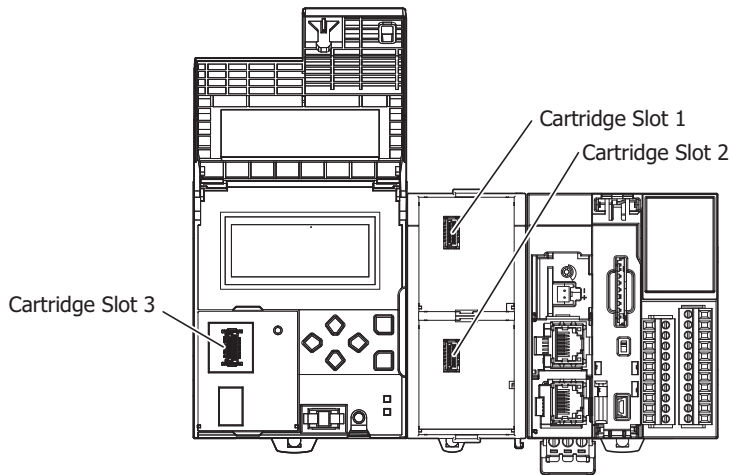

CPU Module	Cartridge Base Module		HMI Module
	Cartridge Slot 1	Cartridge Slot 2	Cartridge Slot 3
Plus CPU module	Yes	Yes	Yes

Select the digital I/O cartridges for the connected devices and configure the signal type.

Notes:

- Always install and remove the digital I/O cartridges in the FC6A Series MICROSmart when the power is turned off. If a digital I/O cartridge is installed in or removed from the FC6A Series MICROSmart when the power is on, the product may be damaged. There is also a risk that the digital I/O cartridge may not operate correctly.
- The digital I/O cartridge may be damaged when dropped, so take great care not to drop it when removing it.
- Correctly connect the digital I/O cartridges to the cartridge slots.
- For details on how to install and remove the digital I/O cartridges, see "Assembling the Cartridge Base Module and a Cartridge" on page 3-8.

Digital Input and Output Assignments

The digital inputs or digital outputs are assigned as follows.

	Digital I/O Cartridge		
	Cartridge Slot 1	Cartridge Slot 2	Cartridge Slot 3
Input Device Range	I630 to I633	I634 to I637	I624 to I627* ¹ (All-in-One CPU module/CAN J1939 All-in-One CPU module) I640 to I643 (Plus CPU module)
Output Device Range	Q630 to Q633	Q634 to Q637	Q624 to Q627* ¹ (All-in-One CPU module/CAN J1939 All-in-One CPU module) Q640 to Q643 (Plus CPU module)

*1 As given below, certain digital I/O cartridges cannot be used in cartridge slot 3 depending on the configuration of expansion modules.

Limitations on Using Digital I/O Cartridges

Configuration of Expansion Modules	Digital I/O Cartridges That Cannot Be Used in Cartridge Slot 3
FC6A-N32B3×15	FC6A-PN4
FC6A-T32K3 and FC6A-T32P3×15	FC6A-PTK4, FC6A-PTS4

Assignment Example

When a digital input cartridge is installed in Cartridge Slot 1 and a digital output cartridge is installed in Cartridge Slot 2 of a 40-I/O type CPU module

	CPU Modules 40-I/O Type	Digital I/O Cartridge	
		Cartridge Slot 1	Cartridge Slot 2
Input Device Range	I0 to I27	I630 to I633	—
Output Device Range	Q0 to Q27	—	Q634 to Q637

Digital I/O Cartridge Parameters

Input filter settings are the only parameters available.
 Parameters can be configured for only digital input cartridges.
 Input filter settings can be configured for each digital input.

Input Filter

The input filter is used to adjust the filter width according to the width of the input signal in order to decrease the effects of input contact bounce and noise.

The filter width can be adjusted to a value of 0 ms (no input filter) and 3 to 15 ms (1-ms increments) for each digital input.

For details on the input filter, see "Input Filter" on page 5-42.

Setting Details

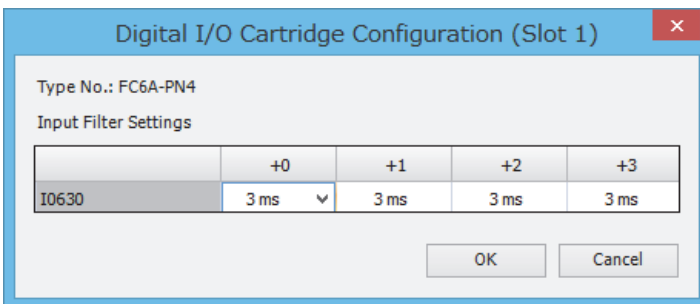

Filter Time (ms)	Description
0	No input filtering
3 to 15	Set the digital input filter time in 1-ms increments.

Setting Procedure

To use digital I/O cartridges, you must configure the digital I/O cartridges that will be used with the Module Configuration Editor in WindLDR and download the user program to the FC6A.

For basic Module Configuration Editor operations, see "Module Configuration Editor" on page 12-1.

This section describes how to insert digital I/O cartridges into the module configuration area and how to configure the input filter.

1. Select the digital I/O cartridge in the expansion modules and cartridges list and drag and drop it to the module configuration area.

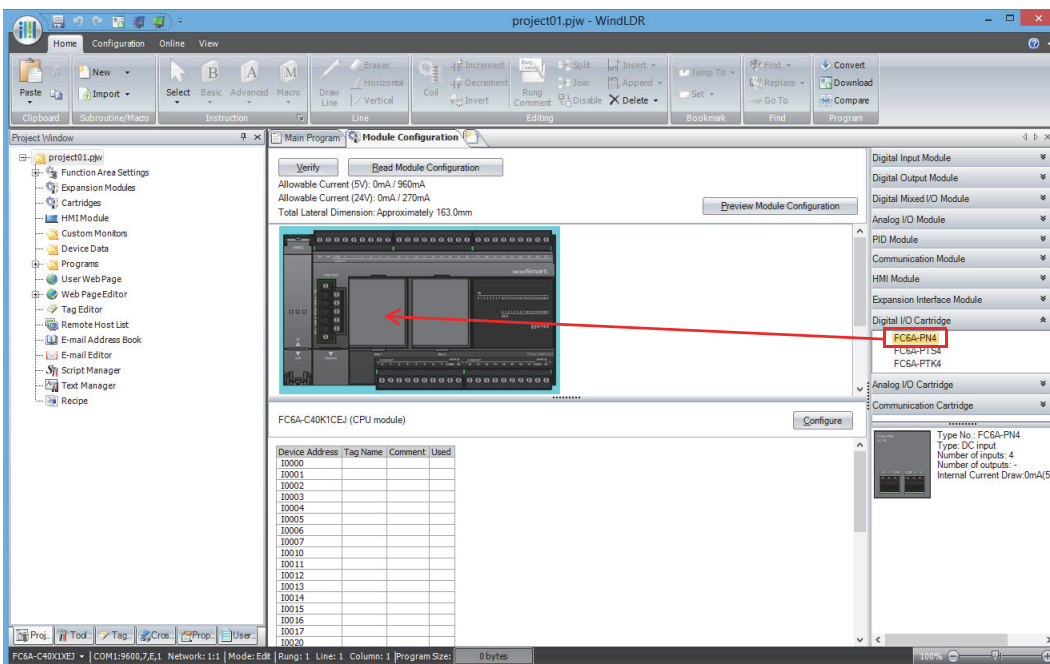

The applicable cartridge is inserted into the module configuration area.

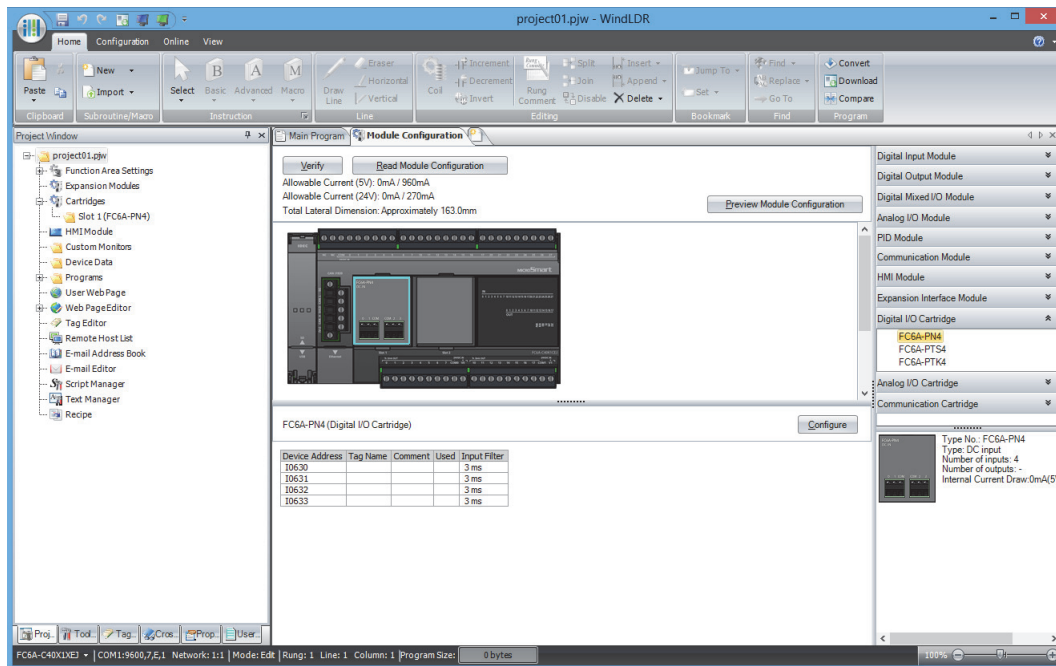

2. Click the inserted digital I/O cartridge in the module configuration area and click **Configure**. The configuration dialog box that corresponds to the digital I/O cartridge is displayed.

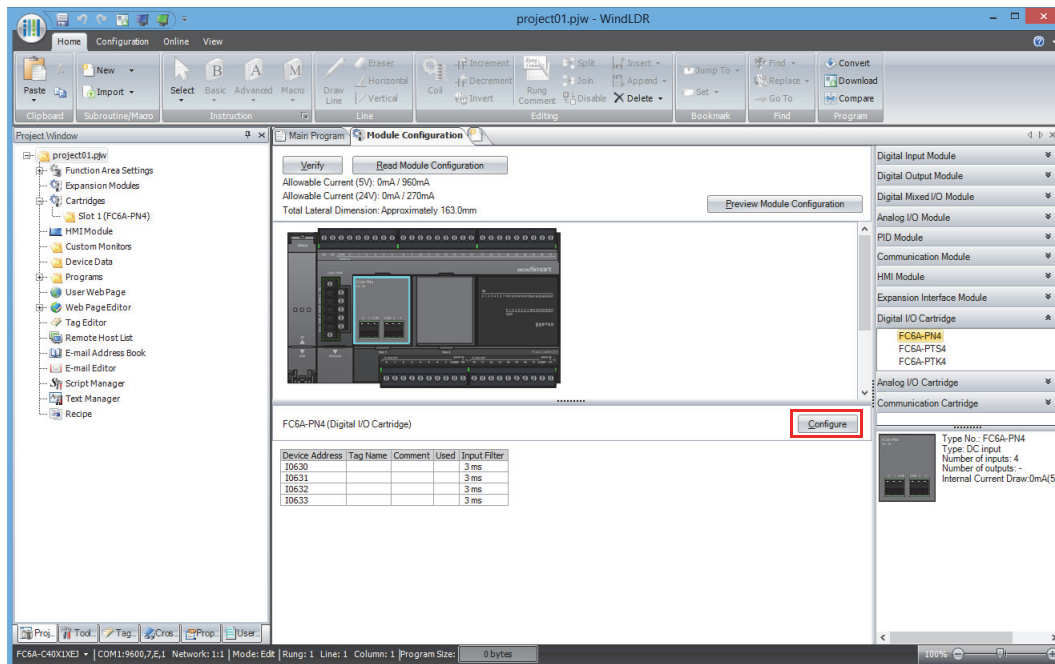

10: I/O CARTRIDGES

3. Enter the filter settings.

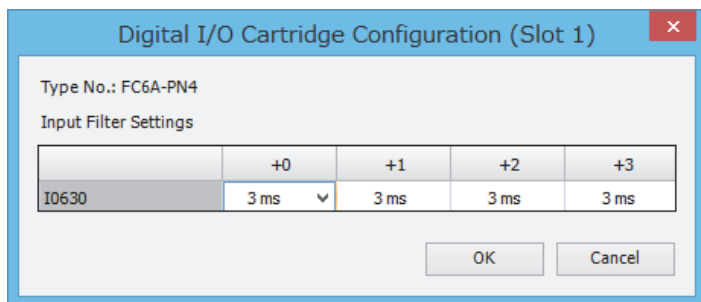

4. Click **OK** to close the **Digital I/O Cartridge Configuration** dialog box.

5. Click **OK**.

This concludes configuring the settings in the application.

Download the user program to the FC6A Series MICROSmart to enable the settings.

Analog I/O Cartridge

Analog I/O Cartridge Overview

This section provides an overview of the analog I/O cartridges and describes the compatible cartridge slots.

Analog I/O cartridges are used to expand the analog inputs or analog outputs. They are available in the analog input type and the analog output type. The analog input type is called the analog input cartridge, and the analog output type is called the analog output cartridge. The analog data and analog status of the analog I/O cartridge is stored in special data registers. For details, see "(6) Data" on page 10-13.

To use an analog I/O cartridge, it must be configured in the Module Configuration Editor. For detailed configuration methods, see "Module Configuration Editor" on page 12-1. For details on the analog parameter settings, see "Analog Parameter Settings" on page 10-11.

Cartridge Slots

All-in-One CPU module/CAN J1939 All-in-One CPU module

The All-in-One CPU module/CAN J1939 All-in-One CPU module are equipped with a maximum of two cartridge slots that are used to install the analog I/O cartridges. The FC6A Series MICROSmart can be expanded with a maximum of four analog inputs or analog outputs by installing a maximum of two analog I/O cartridges.

Furthermore, the FC6A Series MICROSmart can be expanded with a maximum of two analog inputs or analog outputs by connecting the HMI module to the left side of the All-in-One CPU module/CAN J1939 All-in-One CPU module and installing an analog I/O cartridge.

For example, when the HMI module is connected to the 40-I/O type, the FC6A Series MICROSmart can be expanded with a maximum of six analog inputs or analog outputs by installing a maximum of three analog I/O cartridges.

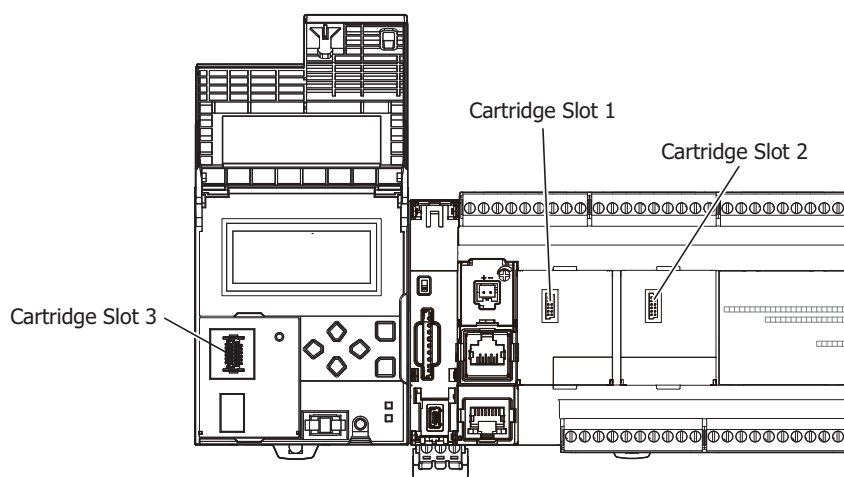

CPU Module		Cartridge Slot 1	Cartridge Slot 2	HMI Module Cartridge Slot 3
All-in-One CPU module	16-I/O type	Yes	—	Yes
	24-I/O type	Yes	—	Yes
	40-I/O type	Yes	Yes	Yes
CAN J1939 All-in-One CPU module		Yes	Yes	Yes

Select the analog I/O cartridges for the connected devices and configure the signal type.



Caution

- Always install or remove the analog I/O cartridges in the FC6A Series MICROSmart when the power is turned off. If an analog I/O cartridge is installed or removed in the FC6A Series MICROSmart when the power is on, the product may be damaged. There is also a risk that the analog I/O cartridge may not operate correctly.
- The analog I/O cartridge may be damaged when dropped, so take great care not to drop it when removing it.
- Correctly install the analog I/O cartridges in the analog I/O cartridge slots.
- For details on how to install and remove the analog I/O cartridge, see "Assembling the CPU Module and a Cartridge" on page 3-6 and "Assembling the HMI Module and a Cartridge" on page 3-7.

10: I/O CARTRIDGES

Plus CPU module

To use analog I/O cartridges with the Plus CPU module, connect a cartridge base module equipped with two cartridge slots to the left side of the Plus CPU module. The Plus CPU module can be expanded with a maximum of four analog inputs or analog outputs by connecting a maximum of two analog I/O cartridges.

Furthermore, the Plus CPU module can be expanded with a maximum of two analog inputs or analog outputs by connecting the HMI module to the left side of the cartridge base module and connecting one analog I/O cartridge.

For example, when the cartridge base module is connected to the Plus CPU module and the HMI module is connected to the cartridge base module, the Plus CPU module can be expanded with a maximum of six analog inputs or analog outputs by connecting a maximum of three analog I/O cartridges.

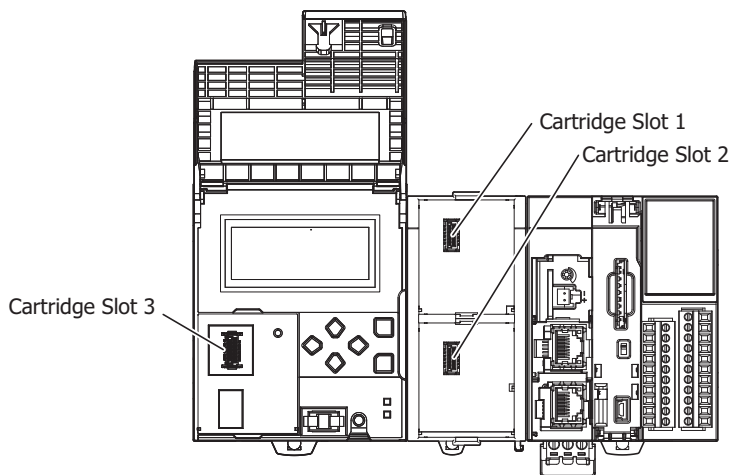

CPU Module	Cartridge Base Module		HMI Module
	Cartridge Slot 1	Cartridge Slot 2	Cartridge Slot 3
Plus CPU module	Yes	Yes	Yes

Select the analog I/O cartridges for the connected devices and configure the signal type.

Caution

- Always install or remove the analog I/O cartridges in the FC6A Series MICROSmart when the power is turned off. If an analog I/O cartridge is installed or removed in the FC6A Series MICROSmart when the power is on, the product may be damaged. There is also a risk that the analog I/O cartridge may not operate correctly.
- The analog I/O cartridge may be damaged when dropped, so take great care not to drop it when removing it.
- Correctly install the analog I/O cartridges in the analog I/O cartridge slots.
- For details on how to install and remove the analog I/O cartridge, see "Assembling the HMI Module and a Cartridge" on page 3-7 and "Assembling the Cartridge Base Module and a Cartridge" on page 3-8.

Analog I/O Cartridge Specifications

This section describes analog I/O cartridge types, how to check the version number, and the analog input and output assignments.

Type Number Configuration

The I/O type, the number of analog inputs or outputs, and the signal types according to the analog I/O cartridge type number are as follows.

Type No.	I/O Type	Number of Analog Points	Signal Type
FC6A-PJ2A	Analog input	2 points	0 to 10 V
			0 to 20 mA
			4 to 20 mA
FC6A-PJ2CP	Analog input	2 points	Type K thermocouple
			Type J thermocouple
			Type R thermocouple
			Type S thermocouple
			Type B thermocouple
			Type E thermocouple
			Type T thermocouple
			Type N thermocouple
			Type C thermocouple
			Pt100
			Pt1000
FC6A-PK2AV	Analog output	2 points	0 to 10 V
			FC6A-PK2AW

Checking the Version Number

The analog I/O cartridge version number is printed on the side of the analog I/O cartridge in the location in the following diagram. The performance and functionality of the analog I/O cartridge will differ by its version, so check the version number before use. For details, see "(7) Status" on page 10-14.

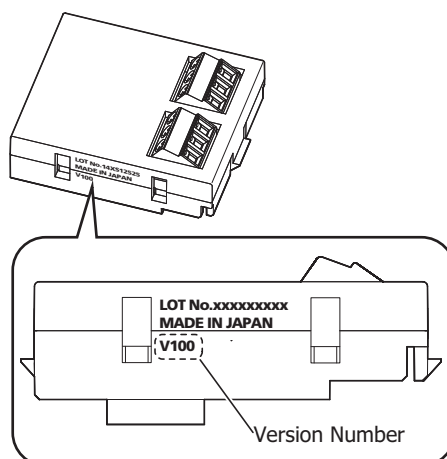

10: I/O CARTRIDGES

Analog I/O Assignments

The analog inputs or analog outputs are assigned as follows.

	All-in-One CPU Module	CAN J1939 All-in-One CPU Module	Analog I/O Cartridge					
			Cartridge Slot 1		Cartridge Slot 2		Cartridge Slot 3	
Channel	—	—	IN0/OUT0	IN1/OUT1	IN0/OUT0	IN1/OUT1	IN0/OUT0	IN1/OUT1
Analog No. (AI/AQ)	AI1	—	AI2/AQ2	AI3/AQ3	AI4/AQ4	AI5/AQ5	AI6/AQ6	AI7/AQ7

Notes:

- AI1 is an All-in-One CPU module analog input. For details, see "Analog Voltage Input" on page 5-44.
- AI0 is an All-in-One CPU module analog potentiometer. For details, see "Analog Potentiometer" on page 5-46.

Assignment Example

- Example 1) The assignments for the 40-I/O type when an analog input cartridge is installed in cartridge slot 1, an analog output cartridge is installed in cartridge slot 2, and an analog output cartridge is installed in cartridge slot 3 on the HMI module

	All-in-One CPU Module	Analog I/O Cartridge					
		40-I/O Type	Cartridge Slot 1		Cartridge Slot 2		Cartridge Slot 3
Channel	—	IN0	IN1	OUT0	OUT1	OUT0	OUT1
Analog input	AI1	AI2	AI3	—	—	—	—
Analog output	—	—	—	AQ4	AQ5	AQ6	AQ7

- Example 2) The assignments for the CAN J1939 All-in-One CPU module when an analog input cartridge is installed in cartridge slot 1

	CAN J1939 All-in-One CPU Module	Analog I/O Cartridge					
		Cartridge Slot 1		Cartridge Slot 2		Cartridge Slot 3	
Channel	—	IN0	IN1	—	—	—	—
Analog input	—	AI2	AI3	—	—	—	—
Analog output	—	—	—	—	—	—	—

Analog Parameter Settings

This section describes the analog parameter settings required to use the analog I/O cartridges.

The analog parameter settings are performed for each channel. In **Expansion Modules Configuration**, configure the parameter settings according to the application.

For detailed configuration methods, see "Module Configuration Editor" on page 12-1.

Setting Details

The analog parameter settings include the filter, signal type, data type, minimum value, maximum value, data, and status.

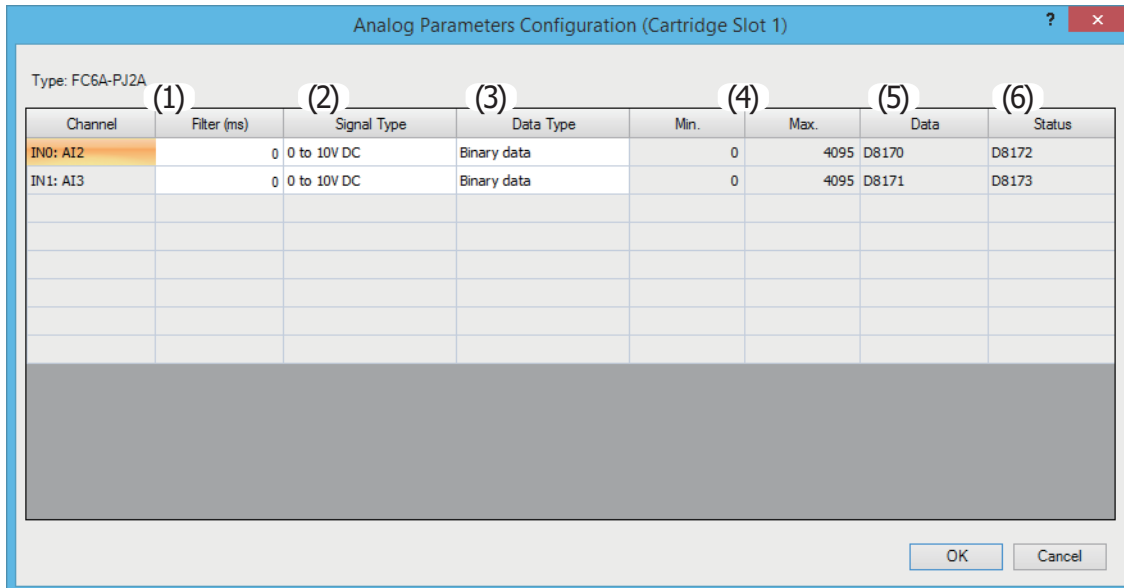

(1) Filter

The analog I/O cartridge's analog input is filtered so it reaches approximately 99% of the analog input in the specified filter. Even when the analog input varies rapidly, the filtered analog input value can be made to vary smoothly by setting the filter. When the filter is set to a large value, the tracking of the filtered analog input value becomes slower in regard to the fluctuations in analog input.

Input filter example

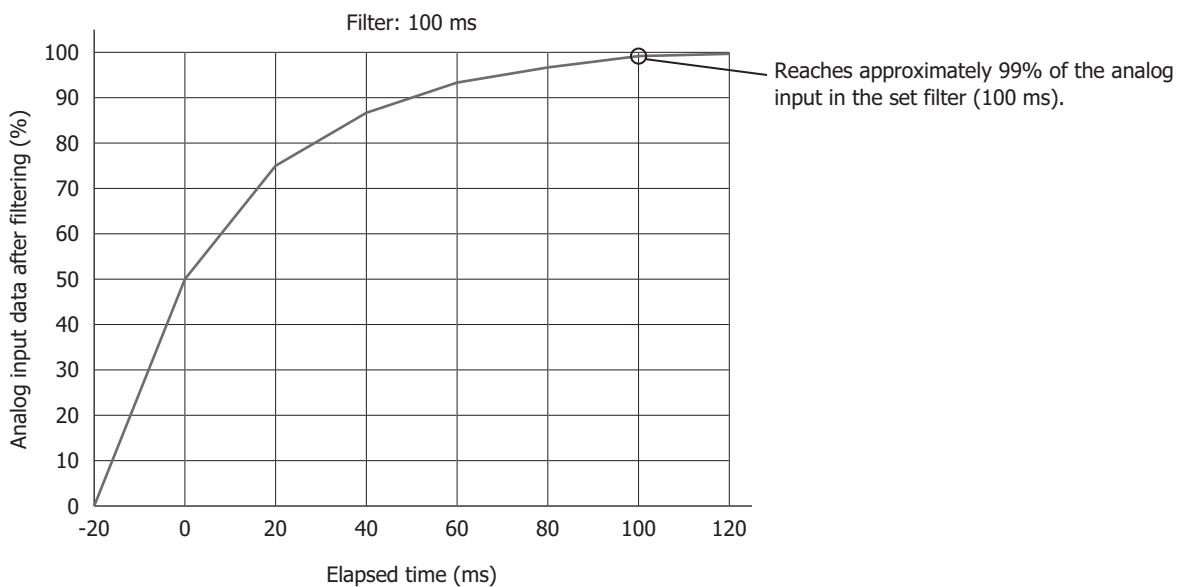

Filter (ms)	Description
0	The value is not filtered.
50 to 50,000	The analog input filter can be set in 50 ms increments. The analog input is filtered so it reaches 99% of the analog input in the specified filter time.

(2) Signal Type

The signal type that can be set differs according to the analog I/O cartridge model. Select the analog I/O cartridge that corresponds to the user application and set the signal type.

For details on signal type, see "Analog I/O Cartridge Specifications" on page 10-9.

(3) Data Type

The analog value can be handled in the range of the specified data type (minimum value to maximum value). The data types are as follows.

Data Type	Description
Binary data	The analog value can be stored in the range of 0 to 4,095.
Optional range	The analog value can be stored in the range of minimum value to maximum value. The minimum and maximum values can be set in the range of -32,768 to 32,767. For the minimum and maximum values, see "(4) Minimum, maximum values of analog value linear conversion" on page 10-12.
Celsius	The analog value can be stored in the linear conversion range of the temperature sensor set as the data type.
Fahrenheit	For details, see the analog input value linear conversion range when set to Celsius or Fahrenheit.

(4) Minimum, maximum values of analog value linear conversion

When **Data Type** is set to "Optional range", these values set the minimum and maximum when performing a linear conversion of the analog value. The minimum and maximum values can be set to any value in the range of -32,768 to 32,767. However, the minimum value must be set to a value smaller than the maximum value.

(5) Linear conversion range of analog input value when set to Celsius or Fahrenheit

When the data type is set to Celsius or Fahrenheit, the analog input value is linearly converted in the range of the following table.

Signal Type	Celsius		Fahrenheit	
	Temperature (0.1°C)	Analog Input Value	Temperature (0.1°F)	Analog input value
Type K thermocouple	-200.0 to 1,300.0	-2,000 to 13,000	-328.0 to 2,372.0	-3,280 to 23,720
Type J thermocouple	-200.0 to 1,000.0	-2,000 to 10,000	-328.0 to 1,832.0	-3,280 to 18,320
Type R thermocouple	0.0 to 1,760.0	0 to 17,600	32.0 to 3,200.0	320 to 32,000
Type S thermocouple	0.0 to 1,760.0	0 to 17,600	32.0 to 3,200.0	320 to 32,000
Type B thermocouple	0.0 to 1,820.0	0 to 18,200	32.0 to 3,308.0	320 to 33,080
Type E thermocouple	-200.0 to 800.0	-2,000 to 8,000	-328.0 to 1,472.0	-3,280 to 14,720
Type T thermocouple	-200.0 to 400.0	-2,000 to 4,000	-328.0 to 752.0	-3,280 to 7,520
Type N thermocouple	-200.0 to 1,300.0	-2,000 to 13,000	-328.0 to 2,372.0	-3,280 to 23,720
Type C thermocouple	0.0 to 2,315.0	0 to 23,150	32.0 to 4,199.0	320 to 41,990
Pt100	-200.0 to 850.0	-2,000 to 8,500	-328.0 to 1,562.0	-3,280 to 15,620
Pt1000	-200.0 to 600.0	-2,000 to 6,000	-328.0 to 1,112.0	-3,280 to 11,120
Ni100	-60.0 to 180.0	-600 to 1,800	-76.0 to 356.0	-760 to 3,560
Ni1000	-60.0 to 180.0	-600 to 1,800	-76.0 to 356.0	-760 to 3,560

(6) Data

The special data registers that store the analog value and analog status for the analog inputs or analog outputs expanded using analog I/O cartridges are assigned as follows. These values are updated with each scan.

Special Data Register	Description
D8170	Analog I/O cartridge data (AI2/AQ2)
D8171	Analog I/O cartridge data (AI3/AQ3)
D8172	Analog I/O cartridge status (AI2/AQ2)
D8173	Analog I/O cartridge status (AI3/AQ3)
D8174	Analog I/O cartridge data (AI4/AQ4)
D8175	Analog I/O cartridge data (AI5/AQ5)
D8176	Analog I/O cartridge status (AI4/AQ4)
D8177	Analog I/O cartridge status (AI5/AQ5)
D8178	Analog I/O cartridge data (AI6/AQ6)
D8179	Analog I/O cartridge data (AI7/AQ7)
D8180	Analog I/O cartridge status (AI6/AQ6)
D8181	Analog I/O cartridge status (AI7/AQ7)

Notes:

- The values of special data registers for channels that are not used are undefined.
- If the filter is enabled on an analog input, the filtered value is stored in the special data register.
- The analog value and analog status are updated in the scan end processing. The special data register values are updated regardless of whether the FC6A Series MICROSmart is stopped or running.

10: I/O CARTRIDGES

(7) Status

The analog status shows the status of the analog input or analog output for each channel. If the status is 0, this means the value is normal as an analog value.

Analog input

Status	Description				Analog Input Value
0	Operating normally				Current analog input value
1	Converting data (occurs for approximately 500 ms after the power is turned on and after the program is downloaded)				Undefined
2	Initializing				0
3 to 4	Reserved				—
5	Wiring fault (out of maximum range)				Upper limit value
	Signal type	Voltage	0 to 10 V	For V100*1: 10.0 V or higher For V201*1 and later: 10.2 V or higher	
		Current	4 to 20 mA	For V100*1: 20.0 mA or higher For V201*1 and later: 20.32 mA or higher	
			0 to 20 mA	For V100*1: 20.0 mA or higher For V201*1 and later: 20.4 mA or higher	
Thermocouple/ resistance thermometer	Upper limit value or higher				
6	Wiring fault (out of minimum range, open current loop)				Lower limit value
	Signal type	Voltage	0 to 10 V	For V100*1: 0 V or lower For V201*1 and later: -0.2 V or lower	
		Current	4 to 20 mA	For V100*1: 4.0 mA or lower For V201*1 and later: 3.68 mA or lower	
			0 to 20 mA	For V100*1: 0 mA or lower For V201*1 and later: -0 mA or lower	
Thermocouple/ resistance thermometer	Lower limit value or higher				
7	Reserved (analog I/O cartridge correction value error)				—
8	There is a difference in the configured content for the installed analog I/O cartridge and the user program				Undefined
9	The analog I/O cartridge has not been installed				Undefined
10	The analog I/O cartridge has been installed, but the type has been set to unused				Undefined
11 to 65,535	Reserved				—

*1 The analog I/O cartridge version number is printed on the side of the analog I/O cartridge. For details, see "Checking the Version Number" on page 10-9.

Analog output

Status	Description	Analog Output Signal
0	Operating normally	Current analog output value
1	Reserved	—
2	Initializing	0 V / 4 mA
3	Parameter setting error	Analog output value immediately before the error occurred
4 to 7	Reserved	—
8	There is a difference in the configured content for the installed analog I/O cartridge and the user program	0 V / 4 mA
9	The analog I/O cartridge has not been installed	—
10	The analog I/O cartridge has been installed, but the type has been set to unused	0 V / 4 mA
11 to 65,535	Reserved	—

11: SD MEMORY CARD

This chapter provides an overview of the SD memory card, describes its specifications, and describes the functions that can use the SD memory card.

SD Memory Card Overview

The FC6A Series MICROSmart CPU module is equipped with one SD memory card slot which can use a FAT16 formatted SD memory card and a FAT32 formatted SDHC memory card.

Notes:

- This manual does not distinguish between SD memory cards and SDHC memory cards, both are referred to as "SD memory card".
- For accessing the SD memory card cover and for how to install or eject the SD memory card, see "Using an SD Memory Card" on page 3-30.

SD Memory Card Functions List

The functions that can use SD memory cards are as follows.

Function	Overview	Reference
Save Log Data	Specified device values can be saved to the SD memory card as CSV files using the DLOG and TRACE instructions. When using Plus CPU module, the SD memory card can be replaced while the DLOG and TRACE instructions are being executed.	11-7
Recipe Function	Values that have been prepared in advanced can be batch written to specified devices and specified device values can be batch read according to the state of a device.	11-8
Download from SD Memory Card	The user programs, program comments, and CPU module system software can be downloaded to the CPU module using the SD memory card. The basic settings for MQTT communication can also be downloaded to the CPU module.	11-27
Upload to SD Memory Card	The user programs, program comments, and CPU module system software written to the CPU module can be uploaded to the SD memory card.	11-43
SD Memory Card Maintenance with Data File Manager	The data on the SD memory card inserted in the FC6A Series MICROSmart SD memory card slot can be managed and checked using Data File Manager. Data on the SD memory card can also be saved to a PC or deleted.	11-48

11: SD MEMORY CARD

SD Memory Card Specifications

Specifications

Item		Specifications
Compatible SD Memory Card		SD memory cards (max 2 GB), SDHC memory cards (max 32 GB)
File System		FAT16/FAT32 Note, SD memory cards are supported only when formatted as FAT16. SDHC memory cards are supported only when formatted as FAT32. Malfunctions may occur if a different format type is used.
File Specifications	Format	CSV file, ZLD file
	File size	5 MB maximum (Plus CPU module 256 MB maximum)
	Supported Characters	Single-byte alphanumeric characters The following characters cannot be used in drive names: \" & () * + , . / : ; < > [] = ^ The following characters cannot be used in file or folder names: \\ / : * ? " < >
Maximum Number of Files		Dependant on file system: <ul style="list-style-type: none"> FAT16 Subdirectory and below: Maximum 65,534 FAT32 Subdirectory and below: Maximum 65,534

Recommended SD Memory Card

Recommended SD Memory Card	SDHC memory card (32 GB maximum)
----------------------------	----------------------------------

Note: We recommend using SD memory cards that have been formatted on the FC6A Series MICROSmart.

Note: We recommend that important data is regularly backed up on separate media such as CDs or DVDs.

SD Memory Card Status

The status of the SD memory card can be checked with the SD memory card status LED [SD] and the special internal relays.

 Caution	The SD memory card data may be corrupted by doing the following during access to the SD memory card. <ul style="list-style-type: none"> Turning the FC6A Series MICROSmart power OFF. Ejecting the SD memory card.
	When ejecting the SD memory card, do so when the FC6A Series MICROSmart power has been turned off, or when the SD memory card has been unmounted by turning on M8072.

SD Memory Card Status LED [SD] and SD Memory Card Status

The SD memory card status LED [SD] turns on or flashes when the SD memory card has been recognized, while it is being formatted, and while it is being read from or written to.

SD Memory Card Status LED [SD] Display	SD Memory Card Status	Operation
On	<ul style="list-style-type: none"> Standby status where the SD memory card can be read from or written to 	The SD memory card can be ejected.
Slow flashing (1 s cycle)	<ul style="list-style-type: none"> While the FC6A Series MICROSmart is recognizing the SD memory card The FC6A Series MICROSmart is unmounting the SD memory card because unmount SD memory card (M8072) was turned on 	Do not eject the SD memory card.
Quick flashing (100 ms cycle)	<ul style="list-style-type: none"> Reading or writing the SD memory card 	
Off	<ul style="list-style-type: none"> The SD memory card is not inserted An unsupported or unformatted SD memory card was inserted Unmount SD memory card (M8072) is on, so the SD memory card has been unmounted The FC6A Series MICROSmart power is off 	If the SD memory card is inserted, it can be ejected.

Special Internal Relays for the SD Memory Card

The special internal relays (M8070, M8071) are turned on and off according to the SD memory card insertion status and access status. When special internal relay M8072 is turned on, access to the SD memory card is stopped.

Device Address	Function	Description	R/W
M8070	SD Memory Card Mount Status	When an SD memory card is inserted in the FC6A Series MICROSmart and it has been recognized and can be used, M8070 is turned on. M8070 is turned off if no SD memory card has been inserted or if it is not recognized.	R
M8071	Accessing SD Memory Card	M8071 is turned on while the SD memory card is being accessed. It is turned off when access has finished.	
M8072	Unmount SD Memory Card	When M8072 is turned on, access to the SD memory card is stopped. To make an SD memory card accessible that has had access to it stopped, insert the card once again.	R/W

Note: R/W stands for read/write and allows reading and writing. R is read-only. W is write-only.

Timing Chart

The special internal relays are turned on and off in the following manner according to the SD memory card insertion status and access status.

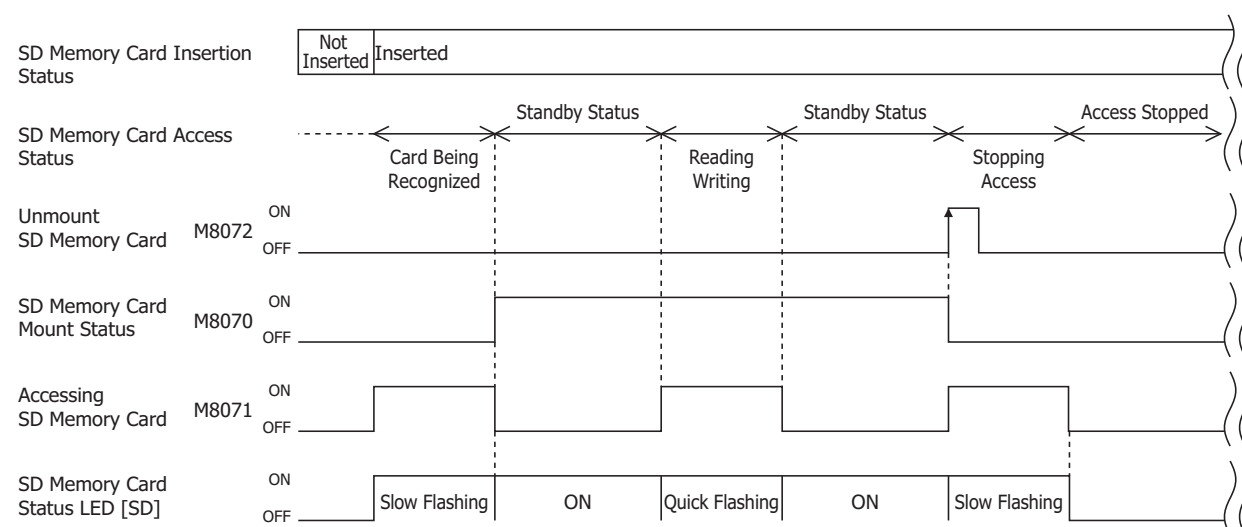

Special Data Registers for the SD Memory Card

The capacity and free space of the SD memory card inserted in the FC6A Series MICROSmart can be checked with special data registers.

Device Address	Function	Description	R/W
D8250	Read SD Memory Card Capacity	This register indicates the capacity of the recognized SD or SDHC (maximum size 32 GB) memory card in megabytes. It is 0 when no SD memory card has been inserted or if it is not recognized.	R
D8251	Read SD Memory Card Free Capacity	This register indicates the free capacity of the SD memory card in megabytes. It is 0 when no SD memory card has been inserted or if it is not recognized.	

Note: R/W stands for read/write and allows reading and writing. R is read-only. W is write-only.

SD Memory Card Folder Structure and Files

Folder Structure

When downloading or uploading data using the FC6A Series MICROSmart or WindLDR, the following files and folders are accessible.

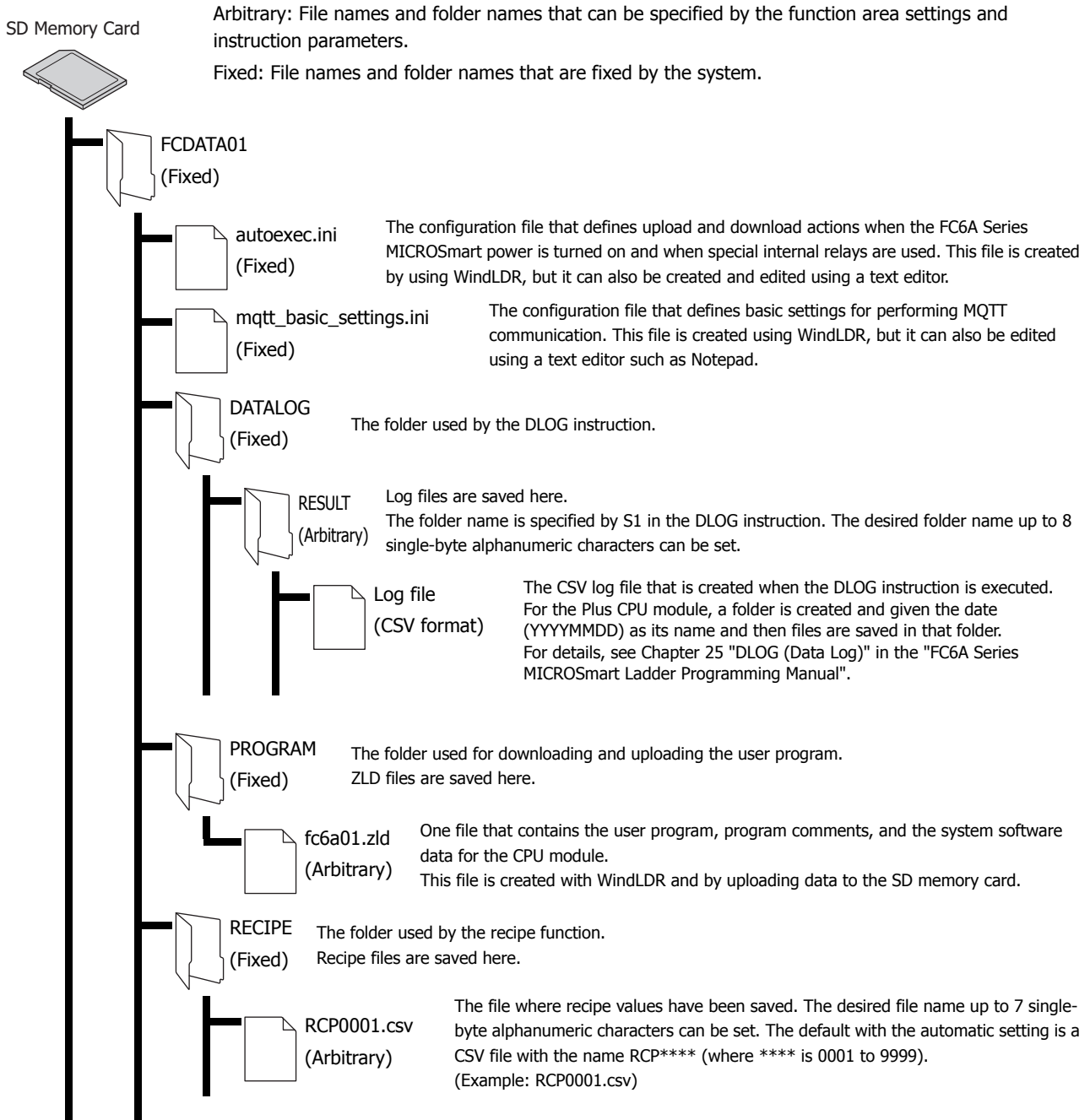

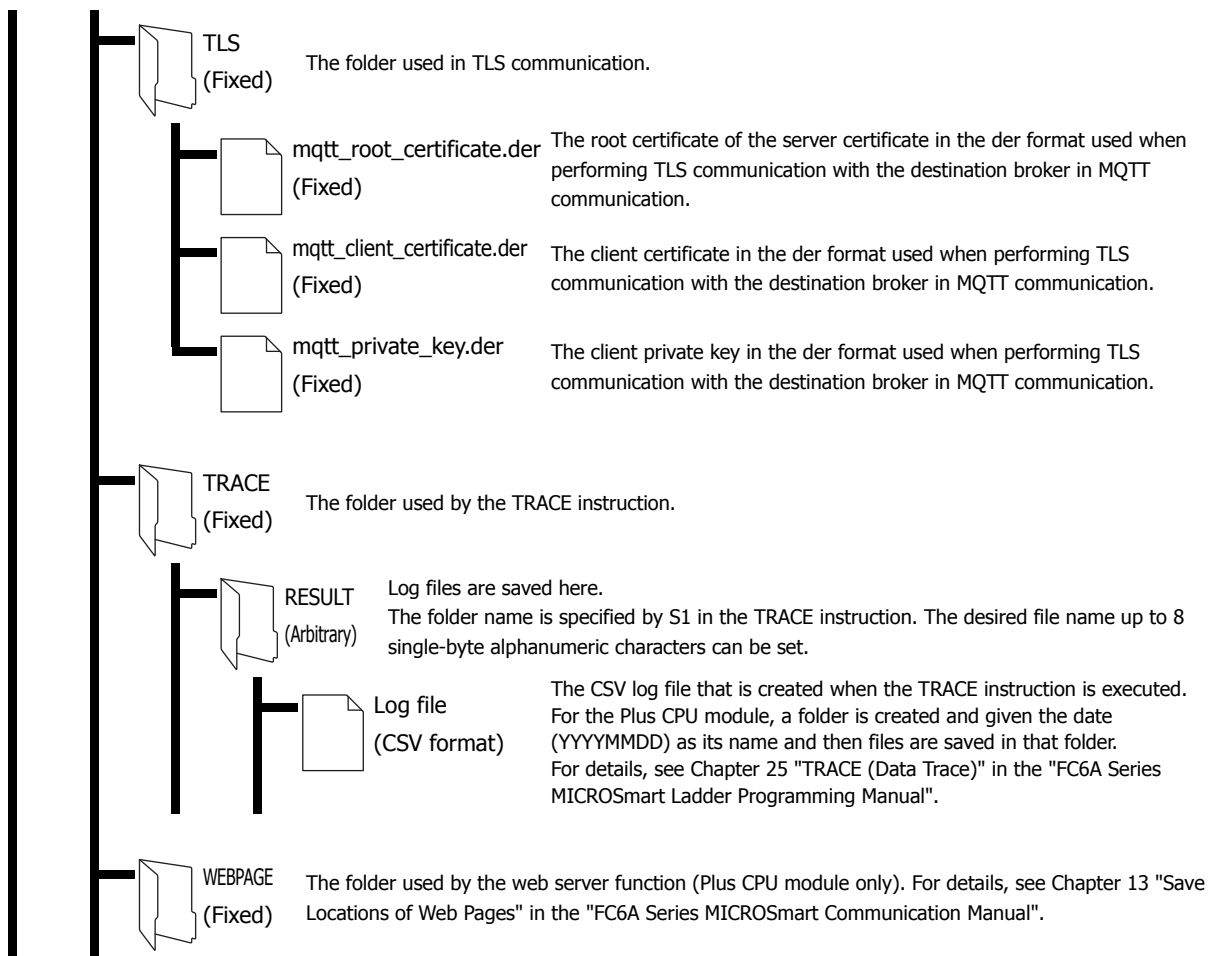

Note: The following group of four files is referred to as the files for MQTT Basic Settings.

- mqtt_root_certificate.der
- mqtt_client_certificate.der
- mqtt_private_key.der
- mqtt_basic_settings.ini

11: SD MEMORY CARD

ZLD Files

Downloads and uploads with the SD memory card use ZLD files that contain the user program, program comments, and system software data in a single file.

ZLD files are created with WindLDR or by uploading to the SD memory card. Data can be reused and edited by opening the ZLD file in WindLDR.

When creating a ZLD file with WindLDR, the data other than the user program can be optionally set. The version of the CPU module system software can also be specified and set.

When downloading from the SD memory card, the data in the ZLD file cannot be partially selected and downloaded. To change the data that will be download according to the application, create it as a separate ZLD file.

The data that is written to the ZLD file is as follows.

ZLD File Data	When Creating ZLD Files in WindLDR	When the CPU Module Creates ZLD Files by Uploading Data to the SD Memory Card
User program	Set from a created user program.	The user program running on the CPU module is written.
Program comments	Set the user program comments. (Optional)*1	The program comments running on the CPU module are written.
CPU module system software	Specify and set the CPU module system software version. (Optional)*1	The system software running on the CPU module is written.

*1 If the applicable data is not set in the ZLD file, the corresponding data will not be downloaded.

The created ZLD file is saved to the \FCDATA01\PROGRAM\ folder on the SD memory card. ZLD files can be saved to folders other than the \FCDATA01\PROGRAM\ folder, but these will not be downloaded from the SD memory card. Alpha-numeric characters, "-" (hyphens), "_" (underscores), and spaces can be used for the file name.

autoexec.ini File

Using the autoexec.ini file, the file name and action can be changed when downloading or uploading a ZLD file when the FC6A Series MICROSmart power is turned on and by special internal relay operations. The autoexec.ini file is created by using WindLDR or a text editor. Only the autoexec.ini file saved to \FCDATA01\ on the SD memory card is valid.

For the autoexec.ini file format, see "autoexec.ini File Format" on page 11-36.

mqtt_basic_settings.ini File

The basic settings for performing MQTT communication, root certificate of the server certificate, client certificate, and client private key can be downloaded to the CPU module by using an mqtt_basic_settings.ini file when the FC6A Series MICROSmart power is turned on and by special internal relay operations. The mqtt_basic_settings.ini file is created by using WindLDR or a text editor. Only the mqtt_basic_settings.ini file saved to \FCDATA01\ on the SD memory card is valid.

For the mqtt_basic_settings.ini file format, see "mqtt_basic_settings. ini File Format" on page 11-41.

Formatting the SD Memory Card

The SD memory card inserted in the FC6A Series MICROSmart CPU module can be formatted by operations with Data File Manager and by menu operations on the HMI module.

For details, see "Formatting the SD Memory Card" on page 11-56 and "Format SD memory card with the FC6A Series MICROSmart" on page 7-42.

Save Log Data

Using the DLOG (data log) instruction and the TRACE (data trace) instruction, specified device values will be saved to the SD memory card as log data (CSV files). The DLOG instruction outputs the date and time and specified device information to the CSV file in the specified folder. The TRACE instruction outputs the date and time and the values for the previous number of scans for the specified devices to the CSV file in the specified folder. For details on the DLOG and TRACE instructions, refer to Chapter 25 "Data Log Instructions" in FC6A Series MICROSmart Ladder Programming Manual.

Note: The following operations are possible with the Plus CPU module.

- When using FC6A Plus CPU module, log data is acquired while the DLOG instruction and the TRACE instructions are executed without an inserted SD memory card. When the SD memory card is inserted, the acquired log data is saved to file and operation of the instruction continues as is.
- If FC6A Series MICROSmart operation is stopped or if the power is cycled without inserting an SD memory card, the acquired log data is entirely cleared.

Note: The FC6A Series MICROSmart cannot write data to the SD memory card when its write-protect switch is on. Always set the SD memory card's write-protect switch to off before inserting it in the FC6A Series MICROSmart.

Output sample

CSV file output sample with the DLOG instruction

Time	D0010	D0011
2011/09/07 15:40:00	12345	1
2011/09/07 15:41:00	1212	3
2011/09/07 15:42:00	345	4

CSV file output sample with the TRACE instruction

Triggered at:	2011/09/07 15:40		
Scan	D0010	D0011	D0012
Old	1	9	17
	2	10	18
New	3	11	19

Replacing the SD Memory Card While Saving Log Data

When using the Plus CPU module, the SD memory card can be replaced while the DLOG (Data Log) and TRACE (Data Trace) instructions are being executed because the Plus CPU module is equipped with 1 MB of internal memory to temporarily save the log data.

SD Memory Card Replacement Procedure

1. Change M8072 (Unmount SD Memory Card) from off to on.
2. Confirm that M8070 (SD Memory Card Mount Status) is off.
3. Eject the SD memory card from the SD memory card slot.
4. Insert the replacement SD memory card into the SD memory card slot.

Notes:

- Format the replacement SD memory card in advance.
- If the power supply for the Plus CPU module is turned OFF while the SD memory card is being replaced, the log data saved to the internal memory will be erased.
- If the log data saved to the internal memory exceeds 1 MB while the SD memory card is being replaced, the execution status of the DLOG (Data Log) instruction or the TRACE (Data Trace) instruction will be "11: RAM overflow", and then subsequent log data are not saved until the SD memory card is inserted.

Recipe Function

This section provides an overview of the recipe function and describes the WindLDR settings.

Recipe Function Overview

The recipe function (or recipes) batch writes values prepared in advanced to specified devices and batch reads the values of specified devices according to the state of a device. Use this function for situations such as configuring the initial values of an external device when starting operation.

Recipe Settings Configuration

The settings that are used with the recipe function are called recipe settings. The recipe settings configuration is as follows.

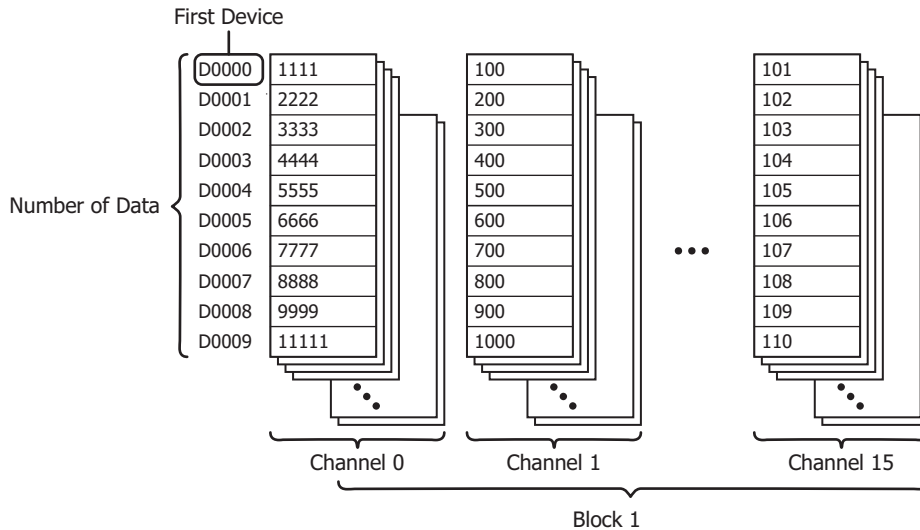

Terminology	Description
Block	The operation that uses recipe data is configured in blocks. A maximum of 64 blocks (1 to 64) can be configured, and each block is made up of 16 channels (0 to 15). (There are locations where these blocks are referred to as recipe blocks in order to avoid confusion with other expressions.)
Channel	The devices and data that are the write destination or read source are set in channels. One first device can be set per channel.
First device	The device that is the start of the read source or write destination devices for recipe values.
Number of Data	The amount of data configured for one channel. Data can be set for device addresses a maximum of 8,192 continuous words from the first device that was set.

Note: If number of data is set to the maximum value (8,192 words), a user program capacity of approximately 16,000 bytes per channel is used. For the capacity of user programs that can be used, see Chapter 5 "User Program Capacity" on page 5-70.

Reading and Writing Data

The data used by the recipe function is called recipe data for data saved in FC6A Series MICROSmart internal memory and recipe files for data saved to the SD memory card, and recipe values for the values written to FC6A Series MICROSmart devices that were saved in recipe data and recipe files.

■ **Write Recipe**

Recipe values can be written to FC6A Series MICROSmart devices according to recipe data or recipe files. Writing starts when the bit of the set device is turned on. The device that serves as the condition to start this writing is called the write trigger device.

To write the recipe values in recipe data saved in FC6A Series MICROSmart internal memory (ROM-user program) to devices

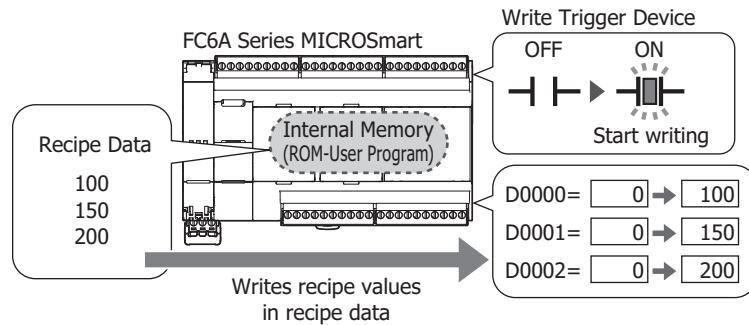

To write the recipe values in recipe data saved in FC6A Series MICROSmart internal memory (ROM-Range) to devices

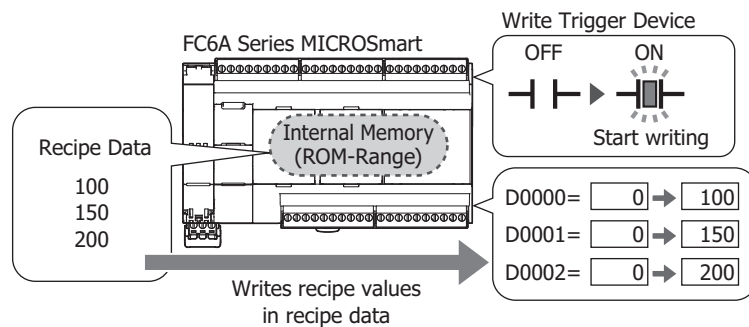

To write the recipe values in a recipe file saved on the SD memory card to devices

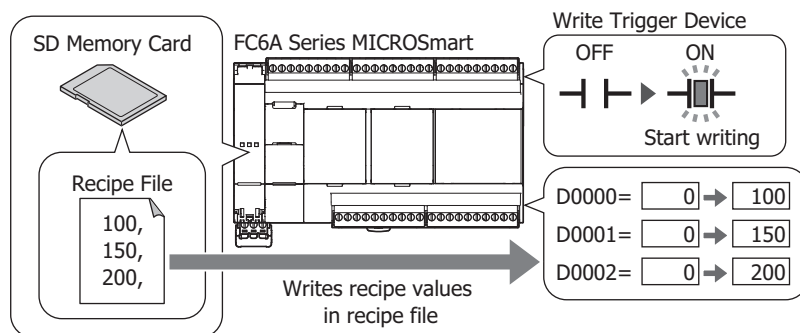

If there are fewer recipe values described in a recipe file than the number of data set for that channel, nothing is written to devices that do not have recipe values to be written.

Example: When the first device is D0000, the number of data to write is 3, and the recipe file describes 2 devices of recipe values. The recipe values are written to D0000 and D0001, but nothing is written to D0002.

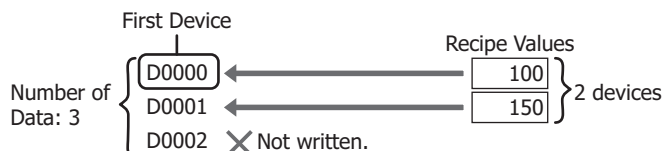

11: SD MEMORY CARD

If there are more recipe values described in a recipe file than the number of data set for that channel, nothing is written to devices in the area that exceeds number of data.

Example: When the first device is D0000, the number of data to write is 3, and the recipe file describes 4 devices of recipe values. The recipe values are written to from D0000 to D0002, but nothing is written to D0003.

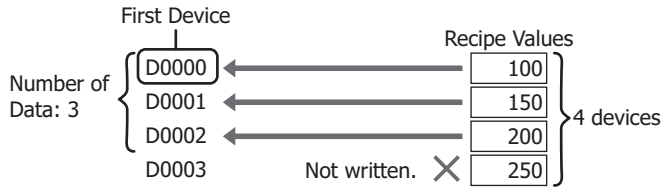

■ Read Recipe

FC6A Series MICROSmart device values can be read and saved to the internal memory (ROM-Range) as recipe data or saved to the SD memory card as a recipe file according to the FC6A Series MICROSmart recipe settings. Reading starts when the bit of the set device is turned on. The device that serves as the condition to start this reading is called the read trigger device.

The file is overwritten when there is already a recipe file with the same name.

To read the device values to FC6A Series MICROSmart internal memory as recipe data

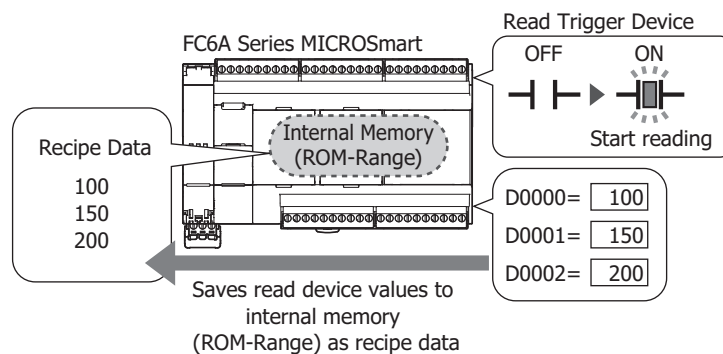

Reads out device values to the SD memory card as a recipe file

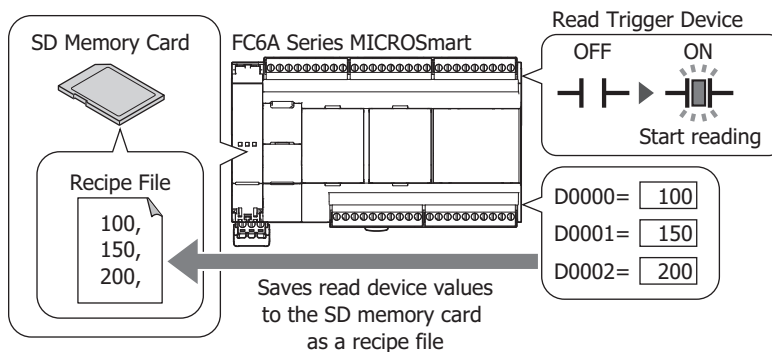

Note:

- When read recipe is executed, a recipe file with the same name on the SD memory card is overwritten. Use caution not to execute a read using the recipe file for writing the initial values.
- Do not turn off the power to the FC6A Series MICROSmart when reading and writing recipes. If the power to the FC6A Series MICROSmart is turned off when reading and writing recipes, the recipe data or recipe file may be corrupted. Use Recipe Block Execution Completed Output (M8266) to check completion of the execution of recipe block reads and writes. Use Recipe Channel Execution Completed Output (M8264) to check completion of the execution of channel reads and writes.
- When the number of times recipe data is read to internal memory (ROM-Range) exceeds 50,000 times, the recipe data save time may increase or the recipe data may not be saved. Consider reading the data to the SD memory card.

■ Auto Write

This function writes recipe values for the specified block numbers at specific times. The write timing can be set as a combination of the following four times.

- When the FC6A Series MICROSmart power is turned on
- When a user program is downloaded to the FC6A Series MICROSmart
- When FC6A Series MICROSmart operation starts
- When the keep data error occurs

A range of block numbers can be specified and all of the channels in the specified block numbers are applicable.

Reading and Writing to Internal Memory (ROM-Range)

If the backup battery dies, the device values are cleared to 0.

The device values can be restored to when the recipe was last read (PLC to recipe) by periodically reading recipes (PLC to recipe) to internal memory (ROM-Range) and then writing recipes (recipe to PLC) after recovering from a power loss.

Internal memory (ROM-Range) is split into two areas. Use these areas according to the intended usage.

■ Configure the same recipe settings in the two internal memory (ROM-Range) areas and use for backups

If the CPU module power is turned off while reading the recipe (PLC to recipe), the recipe cannot be read correctly. If the same recipe settings are configured in internal memory (ROM-Range 1) and internal memory (ROM-Range 2), even if reading the recipe (PLC to recipe) fails for one recipe, the other area stores the device values when the recipe was last read (PLC to recipe). In this case, the two internal memory (ROM-Range) areas are configured with the same recipe settings, and this allows a maximum of 7,000 words of data to be stored.

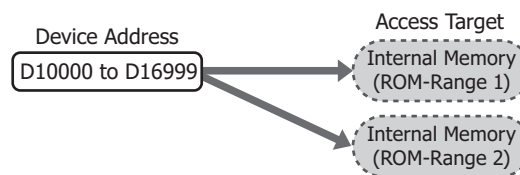

■ Configure each internal memory (ROM-Range) with different recipe settings to save more device values

Configure internal memory (ROM-Range 1) and internal memory (ROM-Range 2) each with different recipe settings.

This allows a maximum of 14,000 words of data to be stored. (Each of the two internal memory (ROM-Range) areas can store a maximum of 7,000 words of data.)



Note:

- The limit on the number of times to read a recipe (PLC to recipe) to internal memory (ROM-Range) is 50,000 times.
- Internal memory (ROM-Range) can be written and read in blocks. It cannot be written and read in channels.
- The amount of data that can be set for 1 block of internal memory (ROM-Range) is a maximum of 7,000 words.
- When reading and writing to internal memory (ROM-Range), **Data Type** on the **Data Editor** dialog box is fixed to **Word (W)**.
- When reading and writing to internal memory (ROM-Range), **Data** on the **Data Editor** dialog box cannot be entered.
- To execute reading recipes (PLC to recipe) to internal memory (ROM-Range), first turn off Read Restriction for Recipe Internal Memory (ROM-Range) (M8267). If recipes are read while M8267 remains on, an error will not occur.
- Internal memory (ROM-Range 1) and internal memory (ROM-Range 2) cannot be set to multiple blocks. Each area can be set to only 1 block each.

Recipe Execution and FC6A Series MICROSmart Status

- Read and write recipe can be executed when the FC6A Series MICROSmart is running or stopped.
- If the FC6A Series MICROSmart is stopped while reading or writing the recipe, reading or writing the recipe continues after stopping.
- If the FC6A Series MICROSmart is set to run while reading or writing the recipe, the FC6A Series MICROSmart automatically runs after reading or writing the recipe has finished.
- Read and write recipe operate in user program END processing regardless of whether the FC6A Series MICROSmart is running or stopped.

Recipe Execution Example

The following shows the processing flow and execution example for when the write trigger device or the read trigger device is on in user program END processing.

■ **Processing flow**

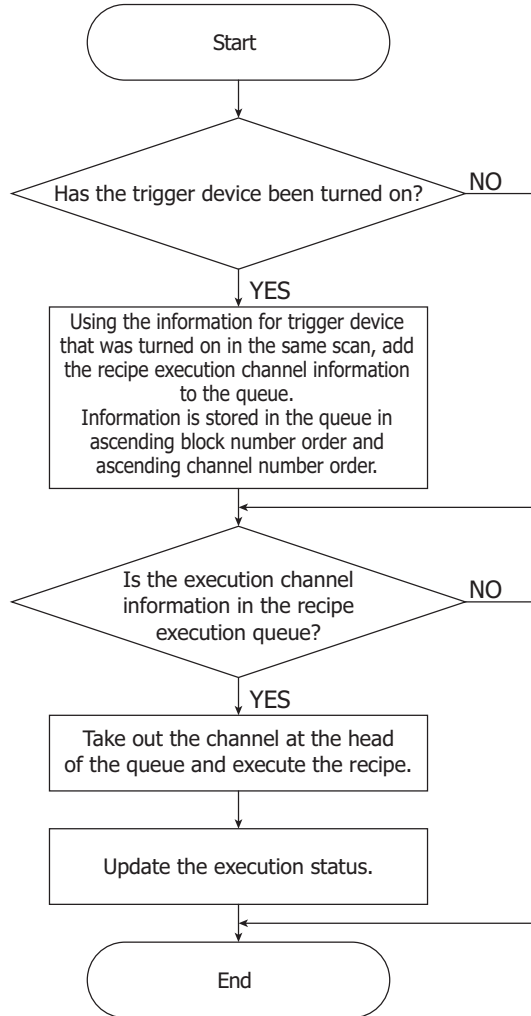

Notes:

- When the auto write function is executed, the first scan starts after recipe block writing has finished.
- If an error occurs during recipe block processing, the recipe function is not executed for subsequent channels.
- If reading and writing are simultaneously executed for the same channel, reading has priority.

■ **Execution example**

When the trigger devices are simultaneously turned on for multiple channels in the same recipe block

Processing is executed in order from the lowest channel number.

Scan	Block Number	Trigger Device			Recipe Execution Status
		Channel 1	Channel 8	Channel 15	
1st scan	1	OFF	OFF	OFF	No operation
2nd scan		OFF -> ON	OFF -> ON	OFF -> ON	Execute channel 1
3rd scan		ON	ON	ON	Execute channel 8
4th scan		ON	ON	ON	Execute channel 15
5th scan		ON	ON	ON	No operation

When the trigger devices are simultaneously turned on for multiple recipe blocks

Processing is executed in order from the lowest recipe block number. However, if a new trigger device is turned on for the recipe block being executed, it will be executed as the new recipe block after reading or writing of the recipe block being executed has finished.

Scan	Block Number	Trigger Device			Recipe Execution Status
		Channel 1	Channel 8	Channel 15	
1st scan	1	OFF	OFF	OFF	No operation
	30	OFF	OFF	OFF	
2nd scan	1	OFF -> ON	OFF	OFF -> ON	Execute channel 1 in block 1
	30	OFF -> ON	OFF	OFF	
3rd scan	1	ON	OFF -> ON	ON	Execute channel 15 in block 1
	30	ON	OFF	OFF	
4th scan	1	ON	ON	ON	Execute channel 1 in block 30
	30	ON	OFF	OFF	
5th scan	1	ON	ON	ON	Execute channel 8 in block 1
	30	ON	OFF	OFF	

Used Special Devices

The special internal relays and the special data registers used by the recipe function are as follows.

Special Internal Relays

Device Address	Function	Description
M8260	Write Recipe Execution Flag	When M8260 is turned on, write recipe is executed.
M8261	Read Recipe Execution Flag	When M8261 is turned on, read recipe is executed.
M8262	Executing Write Recipe	M8262 is turned on when the write recipe processing starts, and it is turned off when the processing has completed. M8262 also is turned off when read recipe processing starts.
M8263	Executing Read Recipe	M8263 is turned on when the read recipe processing starts, and it is turned off when the processing has completed. M8263 also is turned off when write recipe processing starts.
M8264	Recipe Channel Execution Completed Output	M8264 is turned off when starting to read or write a recipe channel, and it is turned on when reading or writing a recipe channel has completed.
M8265	Recipe Execution Error Output	M8265 is turned on when recipe execution has completed and D8264 (Recipe Execution Status) is a value other than 0.
M8266	Recipe Block Execution Completed Output	M8266 is turned off when starting to read or write a recipe block, and it is turned on when reading or writing a recipe block has completed.
M8267	Read Restriction for Recipe Internal Memory (ROM-Range)	M8267 is turned on when reading or writing to a recipe block in internal memory (ROM-Range) has completed. When M8267 is on, recipes cannot be read to internal memory (ROM-Range). When M8267 is off, recipes can be read to internal memory (ROM-Range).

Special Data Registers

Device Address	Function	Description
D8260	Recipe Block Number	The recipe block number to read or write using special internal relays. All channels for the specified block number are applicable.
D8261	Recipe Execution Block Number	The recipe block number of the recipe that was executed. This is updated when the recipe block starts, and the status is retained when completed.
D8262	Recipe Execution Channel No.	The channel number of the recipe that was executed. This is updated when the channel processing starts, and the status is retained when completed.
D8263	Recipe Execution Operation	Information about the operation of the recipe that was executed. For details, see "Recipe Execution Operation (D8263)" on page 11-14.
D8264	Recipe Execution Status	The status of the recipe that was executed. This is 0 when normally terminated. For details, see "Recipe Execution Status (D8264) and Recipe Execution Error Information (D8265)" on page 11-14. M8264 turns on when this device is updated. M8265 also turns on if this device is a value other than 0.
D8265	Recipe Execution Error Information	Error information about the recipe that was executed. This device is updated at the same time as D8264. For details, see "Recipe Execution Status (D8264) and Recipe Execution Error Information (D8265)" on page 11-14.
D8266	Recipe Internal Memory (ROM-Range 1) Read Count	The number of times device values are read to internal memory (ROM-Range 1) as recipe data is stored in this register in units of 100. An error occurs when the actual read count exceeds 50,000 times (value of D8266 > 500).
D8267	Recipe Internal Memory (ROM-Range 2) Read Count	The number of times device values are read to internal memory (ROM-Range 2) as recipe data is stored in this register in units of 100. An error occurs when the actual read count exceeds 50,000 times (value of D8267 > 500).

11: SD MEMORY CARD

Recipe Execution Operation (D8263)

Details about information on the write recipe or read recipe operation that was executed is written to special data register D8263 (Recipe Execution Operation) are as follows.

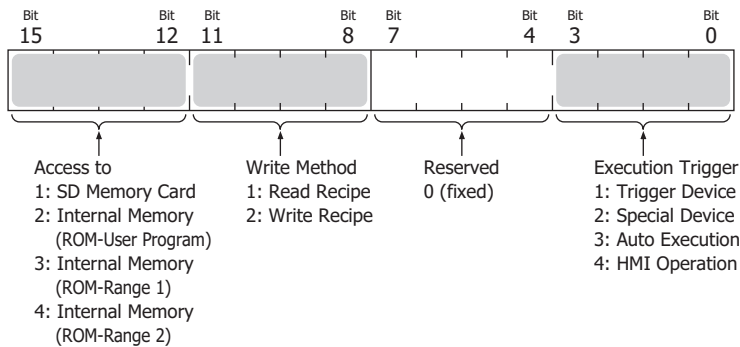

Recipe Execution Status (D8264) and Recipe Execution Error Information (D8265)

Details about the status code that is written to special data register D8264 (Recipe Execution Status) when write recipe or read recipe is executed and details about the error information that is written to special data register D8265 (Recipe Execution Error Information) are as follows.

D8264 (Status Code)	Write Recipe (Recipe to PLC)	Read Recipe (PLC to Recipe)	D8265 (Error Information)
0	Normal termination	Normal termination	0 (fixed)
1	No SD memory card is inserted.	No SD memory card is inserted.	0 (fixed)
2	—	The SD memory card is write protected.	0 (fixed)
3	Invalid SD memory card format.	Invalid SD memory card format.	0 (fixed)
4	—	The SD memory card is full and no folders or files can be created.	The channel number where file creation failed is written to the device.
5	The specified recipe block number is invalid.*2	The specified recipe block number is invalid.	The invalid recipe block number that was specified is written.
6	Failed to read the recipe file on the SD memory card.*3	Failed to read the recipe file on the SD memory card.*3	The channel number where the recipe file read failed is written to the device.
7	There is no recipe file on the SD memory card.	—	The channel number where there is no recipe file is written to the device.
10	There is no recipe data in internal memory (ROM-Range).	—	The channel number where there is no recipe data is written to the device.
11	—	A read to internal memory (ROM-Range) was executed while reading to internal memory (ROM-Range) was restricted (when M8267 is on).	The block number set with internal memory (ROM-Range 1) or internal memory (ROM-Range 2) for the access target is written to the device.
12	—	<ul style="list-style-type: none"> The write limit to internal memory (ROM-Range) was exceeded. The number of times device values were read to internal memory (ROM-Range 1) as recipe data exceeded 50,000 times. Or the number of times device values were read to internal memory (ROM-Range 2) exceeded 50,000 times. 	0 (fixed)
13	Writing recipe data to internal memory (ROM-Range) failed.*4	—	0 (fixed)

*2 This occurs when a block number was accessed that has no settings in the special data registers and special internal relays.

*3 This occurs when file data cannot be normally written or read due to the data in the file becoming corrupted or a failure of a specific area of the SD memory card.

*4 This occurs when recipe data cannot be normally written due to the data in the recipe data in internal memory (ROM-Range) becoming corrupted or a failure of a specific area of internal memory (ROM-Range).

Recipe File Format

The recipe file saved to the SD memory card is a CSV file.

The set data is written on one row.

If the data type is float, the decimal symbol follows **CSV File Format** in **Function Area Settings** > **External Memory** tab. For details, see "External Memory Devices" on page 5-54.

The following shows recipe file examples.

Example 1: Recipe data with data type integer (I), number of data 4

```
234  
-123  
0  
5665
```

Example 2: Recipe data with data type word (W) hexadecimal, number of data 4

```
0123  
55AA  
A6CF  
0000
```

Example 3: Recipe data with data type float (F), number of data 7, decimal symbol setting Period

```
-544.202  
77.0  
1.2E+11  
8.77E-05  
0.0  
84.32  
-0.001
```

File Format Details

- Write only one item of data (device value) on each row.
- A maximum of 40 characters can be converted from the start of the row.

Example: 0.001 Correctly converted because 40 characters.

0.001 Conversion fails because 41 characters.

- If the recipe data conversion fails when writing the recipe, the corresponding device value is 0.
- "0x" or "0X" does not need to be added to hexadecimal values. For example, "1234" and "0x1234" will be the same value "1234h (decimal 4660)".
- When writing float values in exponent notation, do so in a format such as "-12.3E+01". Write "+" or "-" immediately after "E". Write the number of digits for the exponent as 2-digit decimal value. Operation outside of these rules is undefined.

11: SD MEMORY CARD

Programming WindLDR

The recipe settings are configured with the following operation procedure.

1. On the **View** tab, in the **Work Space** group, click **Project Window**.
The Project Window is displayed in the left portion of the screen.
2. Double-click **Recipe**.
Recipe Editor starts.
 - If no blocks are registered, block number 1 recipe settings are created and can be edited.
 - If blocks have already been registered, recipe settings for the lowest block number that has not been registered are created and can be edited.
 - Double-click a registered block number and the recipe settings for that block number can be edited.

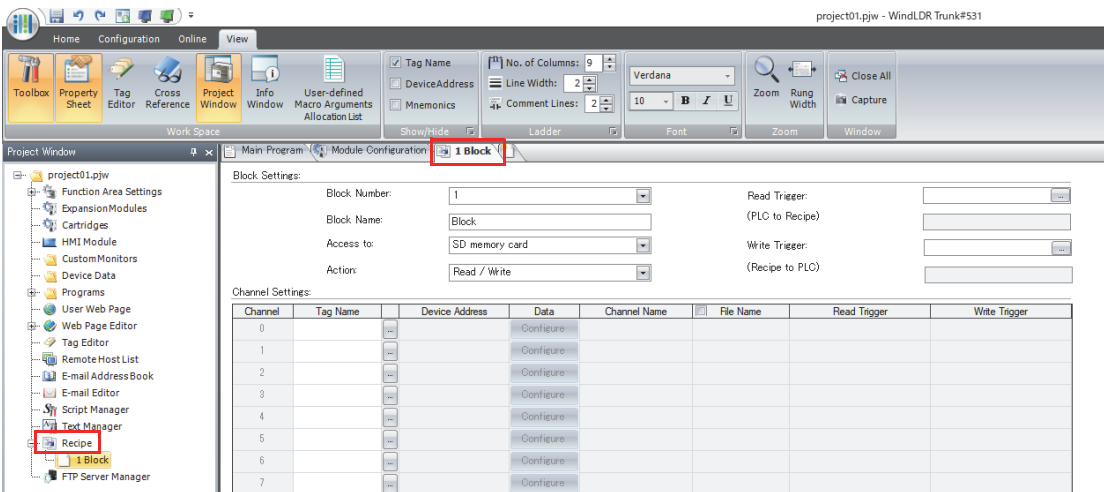

Note: To delete recipe settings that have been created, right-click on the block number and click **Delete** on the menu.

3. Configure the recipe setting parameters.
The recipe settings are saved when the project data is saved.

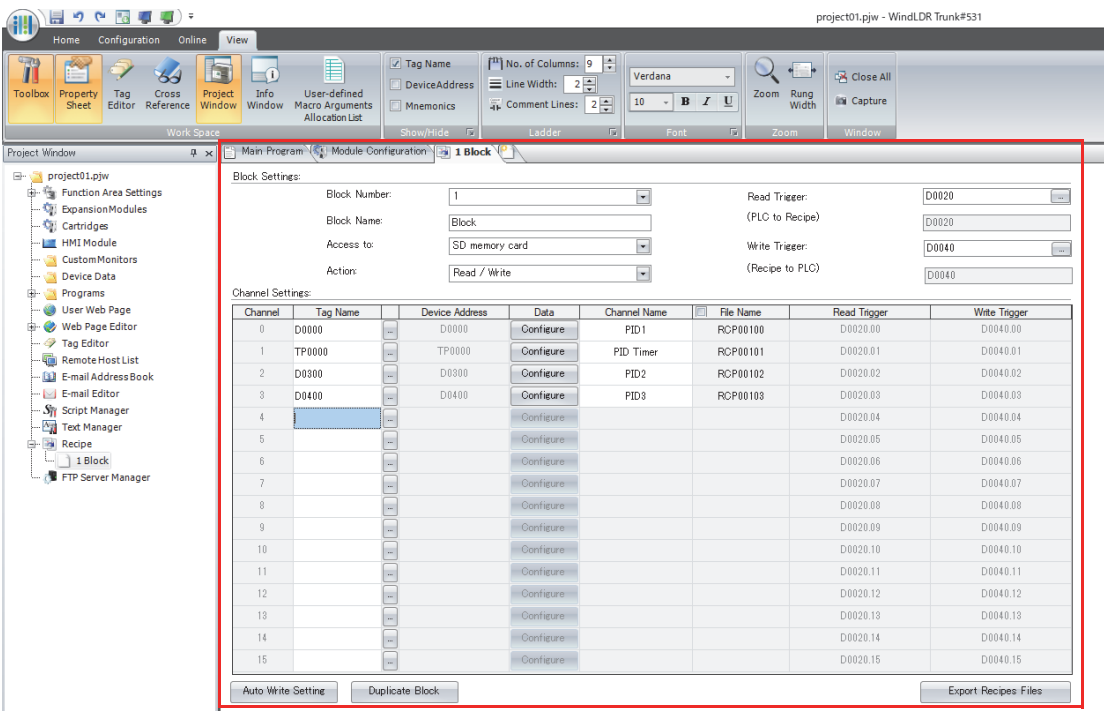

This concludes configuring the recipe settings.

Recipe Function Parameters

This section describes the dialog box parameter settings required to use the recipe function.

Recipe Editor

Use Recipe Editor to collectively manage the save destination for recipe data, the devices for writing recipe values and reading device values, and those execution conditions.

Block Settings:

(2) Block Number: 1 (6) Read Trigger: D0020 (PLC to Recipe)
 (3) Block Name: Block (7) Write Trigger: D0040 (Recipe to PLC)
 (4) Access to: SD memory card
 (5) Action: Read / Write

Channel Settings:

Channel	Tag Name	Device Address	Data	Channel Name	File Name	Read Trigger	Write Trigger
0	D0000	D0000	Configure	PID1	RCP00100	D0020.00	D0040.00
1	TP0000	TP0000	Configure	PID Timer	RCP00101	D0020.01	D0040.01
2	D0300	D0300	Configure	PID2	RCP00102	D0020.02	D0040.02
3	D0400	D0400	Configure	PID3	RCP00103	D0020.03	D0040.03
4			Configure			D0020.04	D0040.04
5			Configure			D0020.05	D0040.05
6			Configure			D0020.06	D0040.06
7			Configure			D0020.07	D0040.07
8			Configure			D0020.08	D0040.08
9			Configure			D0020.09	D0040.09
10			Configure			D0020.10	D0040.10
11			Configure			D0020.11	D0040.11
12			Configure			D0020.12	D0040.12
13			Configure			D0020.13	D0040.13
14			Configure			D0020.14	D0040.14
15			Configure			D0020.15	D0040.15

(9) Auto Write Setting Duplicate Block (10) (11) Export Recipes Files

(1) Recipe Editor tab

Displayed as "Block Number Block Name".

Multiple tabs can be opened and switched between to edit settings.

(2) Block Number

Displays the block number of the block being edited.

The block number of the block being edited can be changed by selecting and changing the number in the list. A confirmation message is displayed when the number is changed. Click **OK**. Already registered block numbers are not displayed in the list.

(3) Block Name

Enter the block name. The name entered here is displayed under **Recipe** on the Project Window.

(4) Access to

Select the save destination for recipe data that is used when the block is executed from the following four options. Internal memory (ROM-Range 1) and internal memory (ROM-Range 2) can be set to only 1 block number each.

- SD Memory Card
- Internal Memory (ROM-User Program)
- Internal Memory (ROM-Range 1)
- Internal Memory (ROM-Range 2)

(5) Action Setting

Select the action that uses the recipe data as the following.

- Read/Write : Saves batch read device values to the SD memory card as a recipe file and writes recipe values to devices. This option can only be configured when **SD Memory Card**, **Internal Memory (ROM-Range 1)**, or **Internal Memory (ROM-Range 2)** is selected under **Access to**.
- Read : Saves batch read device values to the SD memory card as a recipe file. This option can only be configured when **SD memory card** is selected under **Access to**.
- Write : Writes recipe values to devices.

11: SD MEMORY CARD

(6) Read Trigger (PLC to Recipe)

Sets the device that triggers batch reading device values and saving them to the SD memory card as a recipe file. This parameter can be configured when **SD Memory Card** is selected under **Access to** and **Read/Write** or **Read Only** is selected under **Action**.

(7) Write Trigger (Recipe to PLC)

Sets the device that triggers batch writing recipe values to devices by block.

This parameter can be configured when **SD Memory Card** or **Internal Memory (ROM-User Program)** is selected under **Access to** and **Read/Write** or **Write Only** is selected under **Action**.

(8) Channel Settings

Configures the channels.

Channel : Displays the channel numbers.

Tag Name : Sets the tag name for the recipe value write destination device and the device value read source device and the first device.

The set devices are continuously set starting from number 1 in the Data Settings Table in the **Data Editor** dialog box.

Device Address : Displays the tag name set under **Tag Name** or the device address of the first device.

Data button : Click this button to display the **Data Editor** dialog box. The recipe data for the selected channel is configured on this dialog box. For details, see "Data Editor dialog box" on page 11-19.

Channel Name : Enter the channel name.

File Name : Sets the CSV file names when batch saving device values to the SD memory card with read recipe.

When the **File Name** check box is cleared, the file names are the default RCPn (n: 5-digit sequential number). When selected, the name can be entered.

Read Trigger : Displays the read trigger device for each channel. The triggers are automatically allocated starting from the device set for Read Trigger (PLC to Recipe) (6).

Write Trigger : Displays the write trigger device for each channel. The triggers are automatically allocated starting from the device set for Write Trigger (Recipe to PLC) (7).

(9) Auto Write Recipe Setting button

Click this button to display the **Auto Write Settings** dialog box. The execution timing and the range of blocks for the auto write function are configured on this dialog box. For details, see "Auto Write Settings Dialog Box" on page 11-20.

(10) Duplicate Block button

Click this button to display the **Duplicate Block** dialog box. The settings of registered blocks can be copied to other blocks or used to overwrite other blocks. For details, see "Duplicate Block dialog box" on page 11-21.

(11) Export Recipe File button

Saves all Recipe Editor settings in every channel to the SD memory card as a recipe file.

Click this button to display the **Select Drive** dialog box. Specify the SD memory card drive, then click **OK**.

Only channels with **Access to** set to **SD memory card** are saved.

Data Editor dialog box

The recipe data for the channel selected in the Recipe Editor channel settings is configured on this dialog box.

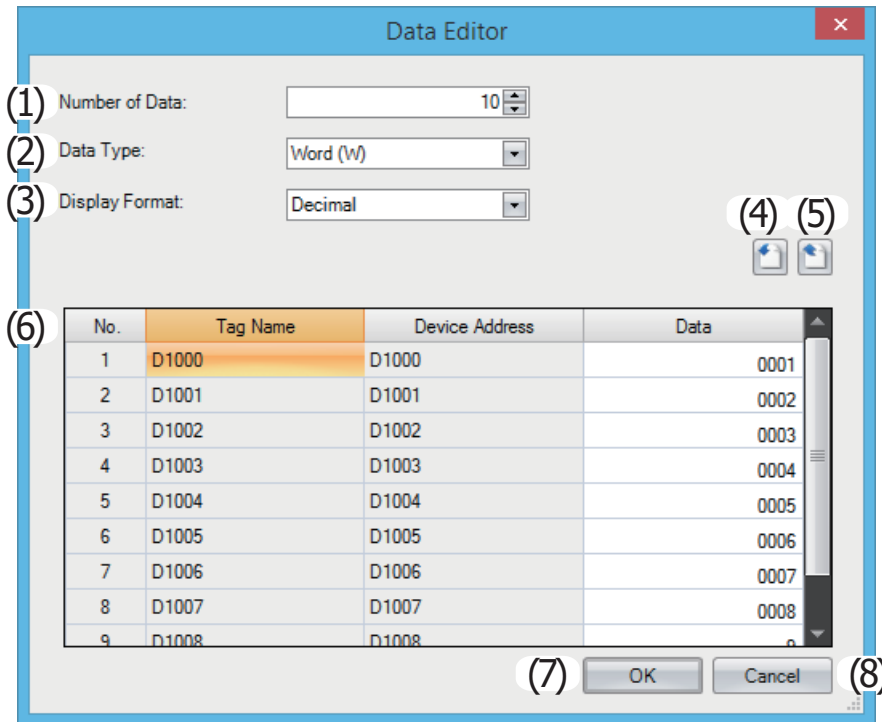

(1) Number of Data

Sets the number of write destination or read source devices starting with the device address of the channel selected in the Recipe Editor channel settings.

The continuous devices from the starting address for the number of configured devices is displayed in the Data Settings Table (6).

(2) Data Type

Selects the type of data for recipe values to write and device values that are read. This option can be configured only when **SD Memory Card** or **Internal Memory (ROM-User Program)** is selected under **Access to** in Recipe Editor.

(3) Display Format

Selects the display format for **Data** in the Data Settings Table as Decimal or Hexadecimal.

Values when saving data to a recipe file are Decimal.

(4) (import) button

Click this button to display the **Open** dialog box.

Select a recipe file and click **Open** to overwrite the data in the Data Settings Table with the selected recipe file.

(5) (export) button

Click this button to display the **Save As** dialog box.

Select the location to save the recipe file, enter a file name, and then click **Save** to save the recipe file for the channel selected in the Recipe Editor channel settings.

The saved recipe file can be edited using Notepad, commercially available text editors, and spreadsheet software.

(6) Data Settings Table

Enter the recipe values to write to the device address for each number of the channel selected in the Recipe Editor channel settings.

- No. : Displays the data numbers for the amount of data specified by **Number of Data**.
- Tag Name : Displays the device address tag names set under **Tag Name** for the channel selected in the Recipe Editor channel settings. If no tag name is set, the device address is displayed.
- Device Address : Continuously set starting from the device address set under **Device Address** for the channel selected in the Recipe Editor channel settings.

11: SD MEMORY CARD

Data : Double-click a cell to enter a recipe value. The value that can be configured varies based on the configured **Data Type** and **Display Format**.

The recipe value cannot be entered when **Read Only** is selected under **Action Setting** in Recipe Editor.
The recipe value also cannot be entered when **Internal Memory (ROM-Range 1)** or **Internal Memory (ROM-Range 2)** is selected under **Access to** in Recipe Editor.

(7) OK button

Saves the Data Editor content and returns to Recipe Editor.

(8) Cancel button

Discards the Data Editor content and returns to Recipe Editor.

Auto Write Settings Dialog Box

The execution timing and the range of blocks for the auto write function are configured on this dialog box.

Auto Write Settings

You can specify the recipe block numbers for each event. When an event occurs, the data of the specified blocks are written to the PLC device addresses.

(1) When PLC is powered on
Start Number:
End Number:

(2) When user program download is completed
Start Number:
End Number:

(3) When PLC starts running
Start Number:
End Number:

(4) When keep data error occurs
Start Number:
End Number:

(5) OK (6) Cancel

The timing to write the recipe values for the block numbers specified for the auto write function can be set by selecting the check boxes.

A range for the block numbers can be specified with **Start Number** and **End Number**. All channels for the specified block numbers are applicable.

(1) When PLC is powered on

The auto write function is executed when the FC6A Series MICROSmart is turned on.

(2) When user program download is completed

The auto write function is executed when the user program has finished downloading to the FC6A Series MICROSmart.

(3) When PLC starts running

The auto write function is executed when the FC6A Series MICROSmart is set to run.

(4) When keep data error occurs

The auto write function is executed when the keep data error occurs.

(5) OK button

Saves the **Auto Write Settings** dialog box content and returns to Recipe Editor.

(6) Cancel button

Discards the **Auto Write Settings** dialog box content and returns to Recipe Editor.

Duplicate Block dialog box

The settings of registered blocks can be copied to other blocks or used to overwrite other blocks.

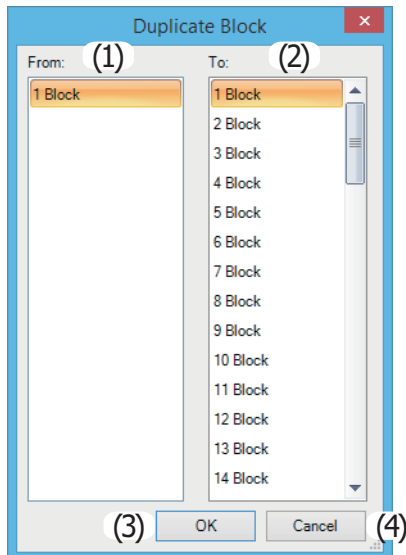
**(1) From**

Select the block number to copy. Only the block names of block numbers that have finished being configured will be displayed.

(2) To

Select the block numbers where the data in the block number selected under From will be copied to.

Multiple block numbers can be selected.

(3) OK button

Click this button to copy the data in the block number selected under **From** to the data in the block numbers selected under **To**, and then to return to Recipe Editor.

The copied blocks are displayed under **Recipe** on the Project Window.

Block numbers that already exist are also overwritten. However, the block number displayed in Recipe Editor will not be overwritten.

(4) Cancel button

Cancels copying the block and returns to Recipe Editor.

SD Memory Card Configuration Dialog Box

Use the **SD Memory Card Configuration** dialog box to configure the parameters required to create the autoexec.ini file, ZLD file, and files for MQTT Basic Settings.

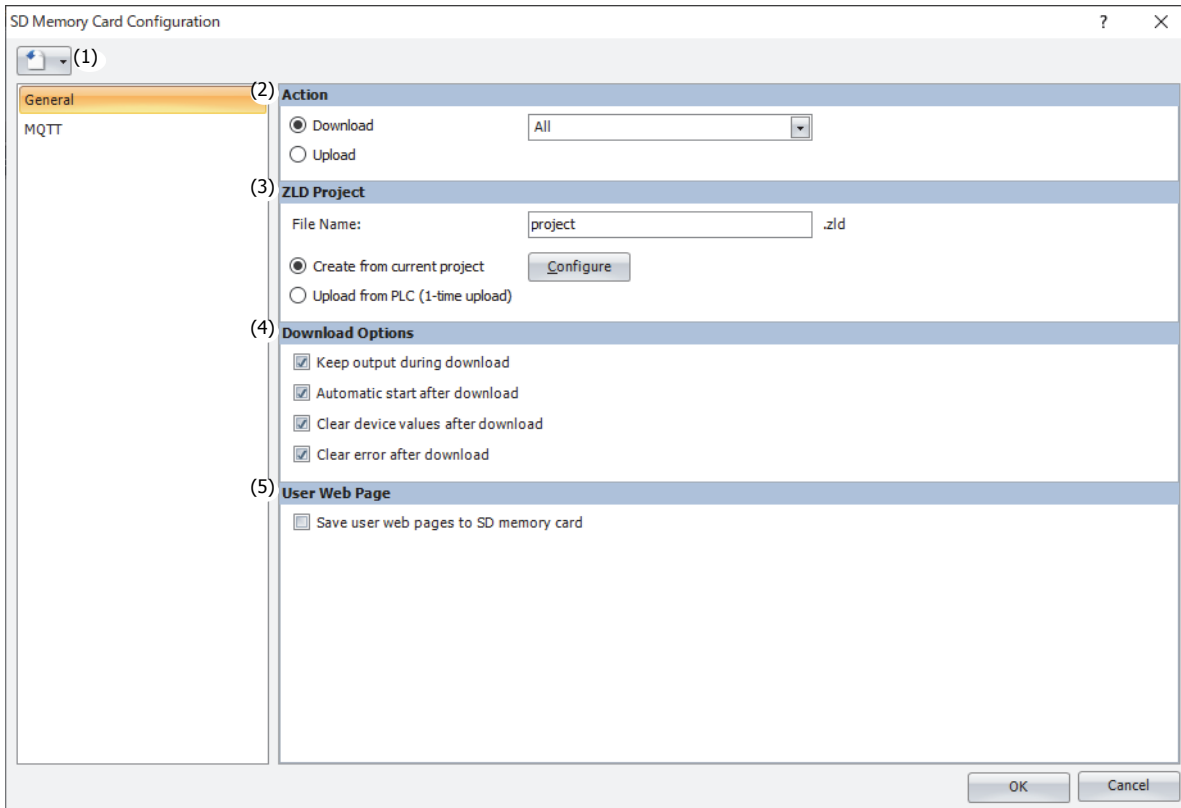

(1) button

Click this button and select the file to import.

Import autoexec.ini : Restores the contents of the selected autoexec.ini file.

Import mqtt_basic_settings.ini : Restores the contents of the selected mqtt_basic_settings.ini file.

Note: Import mqtt_basic_settings.ini is valid only if the **Specify with SD memory card** check box is selected on the **MQTT Settings** dialog box.

■ General Tab

On the **General** tab, configure the settings to create the necessary folder and files for **Action**.

(2) Action

Download

This parameter can be set from the following three targets.

Target	Description
ZLD Project	Downloads a ZLD file to the CPU module. For this setting, specify "download" in "loading_direction" key under the [COMMON_SETTING] section in the autoexec.ini file.
MQTT Basic Settings	Downloads files for MQTT Basic Settings to the CPU module.
All	Downloads a ZLD file and files for MQTT Basic Settings to the CPU module.

Upload

Uploads the ZLD file from the CPU module.

For this setting, specify "upload" in "loading_direction" key under the [COMMON_SETTING] section in the autoexec.ini file.

- **Download a ZLD File**

When Download is selected for Action, (3) and (4) are displayed.

(3) ZLD Project

- | | |
|---------------------------------|--|
| File Name | : Specify the file name of the ZLD file that will be downloaded.
Specify the file name in "src_file" key in the [PROGRAM_DOWNLOAD] section of the autoexec.ini file. |
| Create from current project | : Creates a ZLD file from the currently opened project. Click Configure to display the ZLD Project Configuration dialog box. Configure the details of the ZLD file to download and click OK . For details on the parameters, see "ZLD Project Configuration Dialog Box Parameters" on page 11-35. |
| Upload from PLC (1-time upload) | : Enables the 1-time upload to the SD memory card.
The project downloaded to the CPU module can be uploaded to the SD memory card and then downloaded to other CPU modules. Specify the setting in "onetime_upload" key in the autoexec.ini file. For details, see "ZLD Project Configuration Dialog Box Parameters" on page 11-35. |

(4) Download Options

- | | |
|------------------------------------|--|
| Keep output during download | : Select this check box to keep output while the ZLD file is downloaded.
Specify the setting in "keep_output" key in the autoexec.ini file. |
| Automatic start after download | : Select this check box to automatically set the run status after the ZLD file is downloaded.
Specify the setting in "auto_start" key in the autoexec.ini file. |
| Clear device values after download | : Select this check box to clear the data after the ZLD file is downloaded.
Specify the setting in "clear_data" key in the autoexec.ini file. |
| Clear error after download | : Select this check box to clear the error information after the ZLD file is downloaded.
Specify the setting in "clear_error" key in the autoexec.ini file. |

(5) User Web Page

- | | |
|---------------------------------------|---|
| Save user web pages to SD memory card | : Select this check box to save the user web pages to the SD memory card. The user web pages saved in the SD memory card can be used with the Web server. For details on the web server function, see Chapter 13 "Web Server" in the FC6A Series MICROSmart Communication Manual.
The setting is not written in the autoexec.ini file. |
|---------------------------------------|---|

• Upload a ZLD File

When Upload is selected for Action, (6) is displayed.

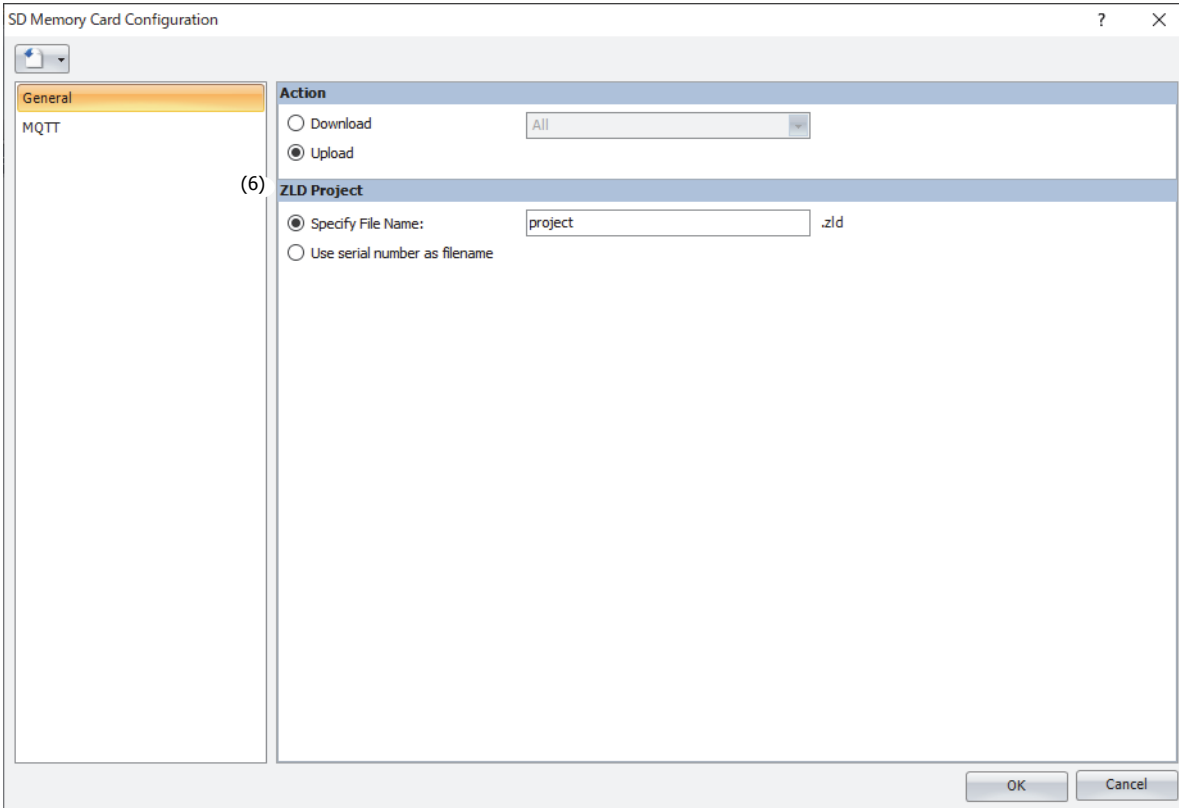

(6) ZLD Project

Specify File Name

: Specify the file name of the ZLD file that will be uploaded. Specify the file name in "dst_file" key in the [PROGRAM_UPLOAD] section of the autoexec.ini file.

Use serial number as filename

: The serial number of the CPU module is used as the file name of the uploaded ZLD file. If the serial number is "12A3456", "12A3456.zld" is created. Specify the setting in "filename_option" key in the [PROGRAM_UPLOAD] section of the autoexec.ini file.

Note: The file name can be set only if the **Specify File Name** radio button is selected.

■ MQTT Tab

On the **MQTT** tab, configure the settings to create the files for MQTT Basic Settings.

The screenshot shows the 'MQTT Basic Settings' window with the following fields and callouts:

- (1) Broker: Radio buttons for Host Name (selected, value: www.example.com) and IP Address (value: 0 . 0 . 0 . 0).
- (2) Port Number: Spin box with value 8883.
- (3) Keep Alive: Spin box with value 60 sec.
- (4) Client ID: Text box with value 7544214b-b349-42e6-9d51-6a3912c97d46. (5) Generate random ID button.
- (6) Authentication is required to connect to Broker: Checked checkbox.
- (7) Account Name: Text box.
- (8) Password: Text box.
- (9) Use secure connection (SSL/TLS): Checked checkbox.
- (10) Root Certificate: Not imported. Import, Details, Delete buttons.
- (11) Client Certificate: Not imported. Import, Details, Delete buttons.
- (12) Client Private Key: Not imported. Import, Delete buttons.
- (13) Delete files for MQTT Basic Settings after download: Checked checkbox.

(1) Broker

Specify the host name or IP address of the broker. The maximum length of the host name is 128 characters. Only alphanumeric characters and symbols can be used.

Specify the host name or IP address in "hostname" key in the [MQTT_BROKER] section of the mqtt_basic_settings.ini file.

(2) Port Number

Specify the port number of the broker. 1883 is normally used for MQTT and 8883 is normally used for MQTT over TLS. Set the port number between 0 and 65,535. The default value is 1883.

Specify the port number in "port_number" key in the [MQTT_BROKER] section of the mqtt_basic_settings.ini file.

(3) Keep Alive

Specify the time interval to execute a connection check for the broker while a connection is made to the broker. If there is no messages exchanged with the Plus CPU module for longer than the specified time interval, a connection check is performed with the broker. The range that can be set is 5 to 65,535 s. The default value is 60 s.

Specify the setting in "keep_alive" key in the [MQTT_KEEP_ALIVE] section of the mqtt_basic_settings.ini file.

(4) Client ID

Specify the client ID. The maximum length of the client ID is 128 single-byte characters. Only alphanumeric characters and symbols can be used.

Specify the client ID in "client_id" key in the [MQTT_CLIENT_ID] section of the mqtt_basic_settings.ini file.

(5) Generate Random ID

Generate a random identifier as the client ID.

(6) Authentication is required to connect to Broker

Specify whether to perform authentication using an account name and password when connecting to the broker. If the check box is selected, authentication is performed using an account name and password when connecting to the broker. The check box is cleared by default.

Specify the setting in "authentication" key in the [MQTT_AUTH] section of the mqtt_basic_settings.ini file.

(7) Account Name/(8) Password

Specify the account name and password when the **Authentication is required to connect to Broker** check box is selected. The maximum length of the account name is 128 single-byte characters, and the maximum length of the password is 496 single-byte characters. Only alphanumeric characters and symbols can be used.

Specify the account name and password in `accountname` and `password` keys respectively in the [MQTT_AUTH] section of the `mqtt_basic_settings.ini` file.

(9) Use secure connection (SSL/TLS)

Specify whether to perform TLS communication with the broker. The check box is cleared by default.

Specify the setting in "use_secure_connection" key in the [MQTT_TLS] section of the `mqtt_basic_settings.ini` file.

(10) Root Certificate

When the **Use secure connection (SSL/TLS)** check box is selected, you can click **Import** to convert a root certificate of a server certificate to use when performing TLS communication with the broker to a der file and save that file to the `\FCDATA01\TLS\` folder on the SD memory card.

Specify the setting in "root_certificate" key in the [MQTT_TLS] section of the `mqtt_basic_settings.ini` file. If a root certificate was imported, the `root_certificate` key is true and an `mqtt_root_certificate.der` file is created. If a root certificate was not imported, the `root_certificate` key is false and an `mqtt_root_certificate.der` file is not created.

(11) Client Certificate

When the **Use secure connection (SSL/TLS)** check box is selected, you can click **Import** to convert a client certificate to use when performing TLS communication with the broker to a der file and save that file to the `\FCDATA01\TLS\` folder on the SD memory card.

Specify the setting in "client_certificate" key in the [MQTT_TLS] section of the `mqtt_basic_settings.ini` file. If a client certificate was imported, the `client_certificate` key is true and an `mqtt_client_certificate.der` file is created. If a client certificate was not imported, the `client_certificate` key is false and an `mqtt_client_certificate.der` file is not created.

(12) Client Private Key

When the **Use secure connection (SSL/TLS)** check box is selected, you can click **Import** to convert a client private key to use when performing TLS communication with the broker to a der file and save that file to the `\FCDATA01\TLS\` folder on the SD memory card.

Specify the setting in "client_private_key" key in the [MQTT_TLS] section of the `mqtt_basic_settings.ini` file. If a client private key was imported, the `client_private_key` key is true and an `mqtt_private_key.der` file is created. If a client private key was not imported, the `client_private_key` key is false and an `mqtt_private_key.der` file is not created.

(13) Delete files for MQTT Basic Settings after download

Specify whether to delete the files for MQTT Basic Settings after the contents are downloaded. If this check box is selected, the files for MQTT Basic Settings are deleted after the contents are downloaded. The check box is cleared by default.

Specify the setting in "delete_files" key in the [MQTT_DELETE_FILES] section of the `mqtt_basic_settings.ini` file.

Note: If **Delete files for MQTT Basic Settings after download** is selected, the `mqtt_basic_settings.ini` file saved in the `\FCDATA01\` folder and the `mqtt_root_certificate.der`, `mqtt_client_certificate.der`, and `mqtt_client_privatekey.der` files saved in the `\FCDATA01\TLS\` folder are all deleted. Make a backup of these files in advance when using this function.

Download from SD Memory Card

The user programs, program comments, and CPU module system software can be downloaded to the CPU module using the SD memory card. The basic settings for MQTT communication can also be downloaded to the CPU module.

Download the Project Being Edited as a ZLD File

A ZLD file can be created from the project opened in WindLDR, and it can be downloaded to the CPU module.

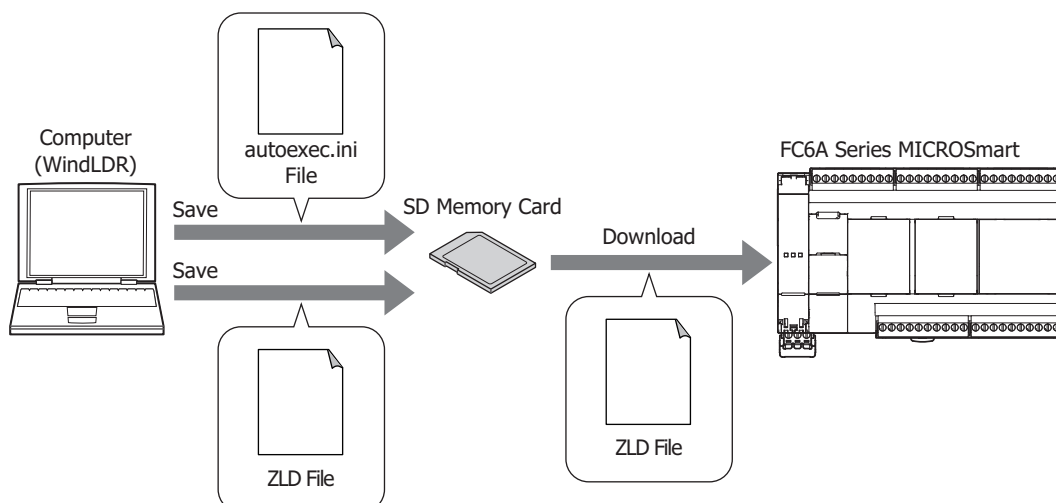

While the ZLD file saved to the SD memory card is being downloaded, CPU module operation stops. When the ZLD file is set to download the CPU module system software, the software is reset in order to rewrite the system software.

The ZLD file saved to the SD memory card can be downloaded by performing the following operations.

Operation	Action	When the CPU Module is Write Protected
The CPU module power is turned on when an SD memory card with an autoexec.ini file that executes a download has been inserted in the SD memory card slot.	The ZLD file specified by the autoexec.ini file is downloaded to the CPU module.	The download is performed if the password matches the write protection password set for the ZLD file to be downloaded specified by the autoexec.ini file.
Special internal relay M8250 is turned on when an SD memory card with an autoexec.ini file that executes a download has been inserted in the SD memory card slot.	The ZLD files saved to the \FCDATA01\PROGRAM\ folder are eligible to be downloaded.	The download is not performed if the passwords do not match.
An SD memory card with an autoexec.ini file that executes a download is inserted in the SD memory card slot.	The download is not performed.	The download is not performed.
A download is executed with the system menu on the HMI module. For details, see "Downloading the User Program (SD memory card -> CPU module)" on page 7-45.	The ZLD file specified with the system menu on the HMI module is downloaded to the CPU module. The ZLD files saved to the \FCDATA01\PROGRAM\ folder are eligible to be downloaded.*1 <ul style="list-style-type: none"> The download is executed even if there is no autoexec.ini file on the SD memory card. Even if there is an autoexec.ini file on the SD memory card, the parameters are not read from it. For details, see "Creating the autoexec.ini File" on page 11-31. 	The download is performed if the password matches the password entered with the HMI module. The download is not performed if the passwords do not match.

*1 The ZLD files that can be selected with the system menu on the HMI module are only those in the PROGRAM folder, and the maximum is 20 files. If there are 21 or more files in the PROGRAM folder, no ZLD file can be selected.

Data that is not saved to a ZLD file will not be downloaded. If the same data as the ZLD file is already in the CPU module, that data will not be downloaded.

11: SD MEMORY CARD

Example 1: When all of the data in the CPU module matches the ZLD file
The download is not executed.

Download	CPU Module Data	Data Stored in the ZLD File on the SD Memory Card	CPU Module Data after Download
CPU Module System Software	Ver1.23	Ver1.23	Ver1.23
User program	Project1	Project1	Project1
Program comments	Comment1	Comment1	Comment1

Example 2: When the system software versions are different
Only the system software will be downloaded.

Download	CPU Module Data	Data Stored in the ZLD File on the SD Memory Card	CPU Module Data after Download
CPU Module System Software	Ver1.23	Ver1.30	Ver1.30
User program	Project1	Project1	Project1
Program comments	Comment1	Comment1	Comment1

Example 3: When the user program and program comments are different
The user program and program comments will be downloaded.

Download	CPU Module Data	Data Stored in the ZLD File on the SD Memory Card	CPU Module Data after Download
CPU Module System Software	Ver1.30	Ver1.30	Ver1.30
User program	Project1	Project2	Project2
Program comments	Comment1	Comment2	Comment2

Download a ZLD File Uploaded from the PLC (1-Time Upload)

When there is no ZLD file to download on an SD memory card with an autoexec.ini file that executes a download, an upload can be executed instead of a download.

By using the auto upload function, the data uploaded from the CPU module can be copied to other CPU modules without having to edit the SD memory card or autoexec.ini file during the process.

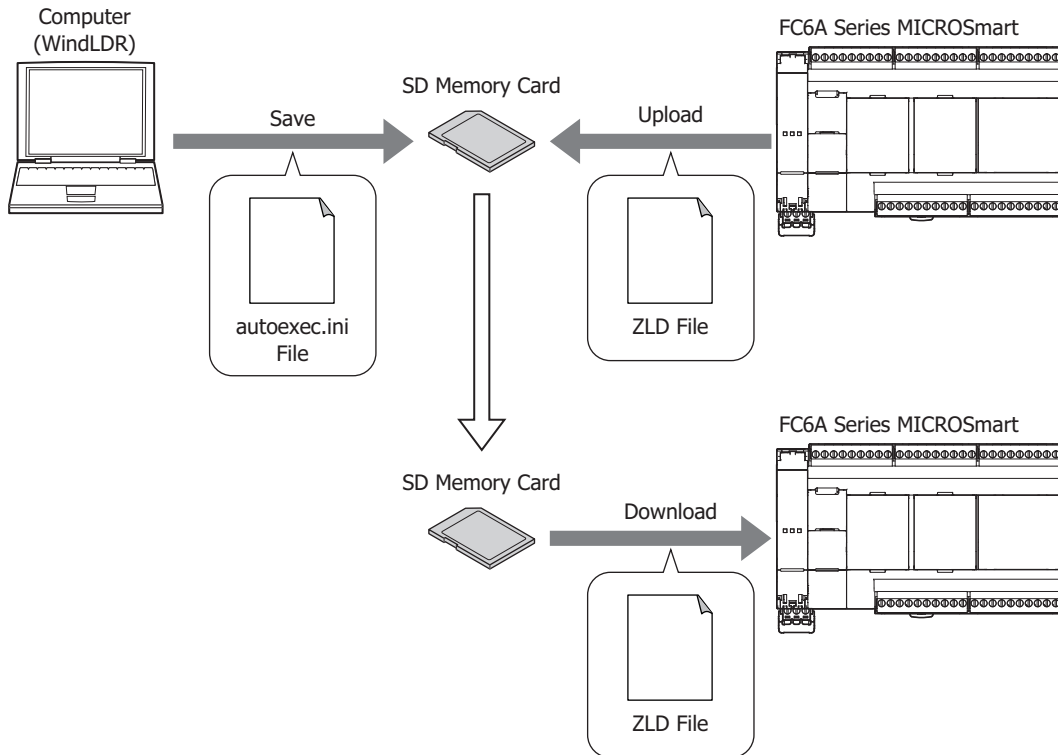

Note: To perform the 1-time upload, it must be enabled in the autoexec.ini file that executes a download. For details, see "autoexec.ini File Format" on page 11-36.

The 1-time upload function can be executed by using the following operations.

Operation	Action	When the CPU Module is Read Protected
The CPU module power is turned on when an SD memory card with an autoexec.ini file that executes an auto upload has been inserted in the SD memory card slot.	The data is uploaded from the CPU module with the ZLD file name specified by the autoexec.ini file. A ZLD file is saved to the \FCDATA01\PROGRAM\ folder.	The upload is not performed.
Special internal relay M8251 is turned on when an SD memory card with an autoexec.ini file that executes an auto upload has been inserted in the SD memory card slot.		
An SD memory card with an autoexec.ini file that executes an auto upload is inserted in the SD memory card slot.		

Download the MQTT Basic Settings

The MQTT basic settings can be downloaded to the Plus CPU module.

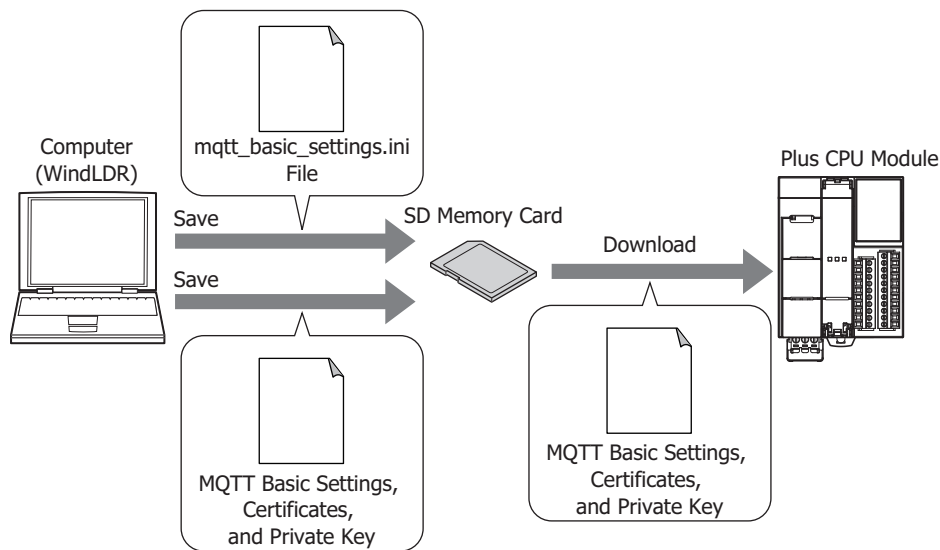

The files for MQTT Basic Settings can be downloaded by performing the following operations.

Operation	Action
The Plus CPU module power is turned on when an SD memory card to which a mqtt_basic_settings.ini file was saved in the \FCDATA01\ folder is inserted in the SD memory card slot.	The setting contents specified by the mqtt_basic_settings.ini file are downloaded to the Plus CPU module.
While the CPU module is running, special internal relay M8271 is turned on when an SD memory card to which a mqtt_basic_settings.ini file was saved in the \FCDATA01\ folder is inserted in the SD memory card slot.	When downloading certificates and other files, the certificates and private key in the der format saved in the \FCDATA01\TLS\ folder are downloaded.
An SD memory card to which a mqtt_basic_settings.ini file was saved in the \FCDATA01\ folder is inserted in the SD memory card slot.	The download is not performed.

Notes:

- The files for MQTT Basic Settings can be downloaded even if the CPU Module is write protected.
- If you select **Specify with SD memory card** check box in **MQTT Basic Settings** on the **MQTT Settings** dialog box, and download that ladder program, make sure to download the files for MQTT Basic Settings from the SD memory card.
- If you clear **Specify with SD memory card** check box in **MQTT Basic Settings** on the **MQTT Settings** dialog box, and download that ladder program, the MQTT basic settings set in the ladder program are used, even if files for MQTT Basic Settings are downloaded from an SD memory card.
- The root certificate, client certificate, and client private key downloaded from the SD memory card cannot be uploaded.
- If an mqtt_basic_settings.ini file exists in the \FCDATA01\ folder on the SD memory card, the files for MQTT Basic Settings will be downloaded to the Plus CPU module each time the Plus CPU module power is turned on. To avoid this from happening, use **Delete files for MQTT Basic Settings after download**. For details, see "SD Memory Card Configuration Dialog Box" on page 11-22.
- The MQTT communication does not work if you saved the pem-formatted root certificate, client certificate, or client private key in the SD memory card and downloaded to the CPU module. Convert the files to the der format and save them to the \FCDATA01\TLS\ folder on the SD memory card. You can use the **SD Memory Card Configuration** dialog box in WindLDR and the Data File Manager to convert pem files to der files. For details on the Data File Manager, see Chapter 4 "Command Line" in the Data File Manager User's Manual.
- For details on MQTT communication, see Chapter 17 "MQTT Communication" in the FC6A Series MICROSmart Communication Manual.

Creating the autoexec.ini File

To download a ZLD file to the CPU module using an SD memory card, save an autoexec.ini file to the SD memory card.

Note: The autoexec.ini file is created according to the file format described in this section. By using WindLDR, the autoexec.ini file can be created by configuring a dialog box and without needing to be aware of the file format. To create the autoexec.ini file using Notepad or another text editor, type in the sections, keys, and parameters according to the file format and save the file as "autoexec.ini".

Creating the autoexec.ini File Using WindLDR

This section describes the operation procedure to create an autoexec.ini file using WindLDR.

• Operation procedure

1. On the **Configuration** tab, in the **SD Card** group, select **Configuration**.

The **SD Memory Card Configuration** dialog box is displayed.

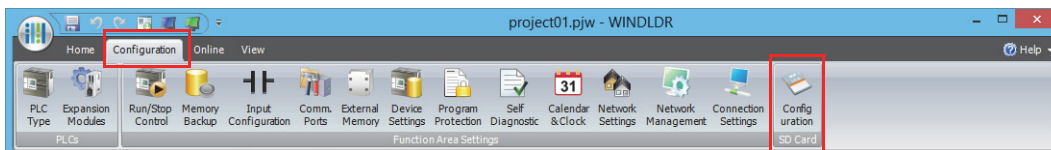

2. Click the **General** tab.

Configure the contents and operation of the autoexec.ini file on this tab.

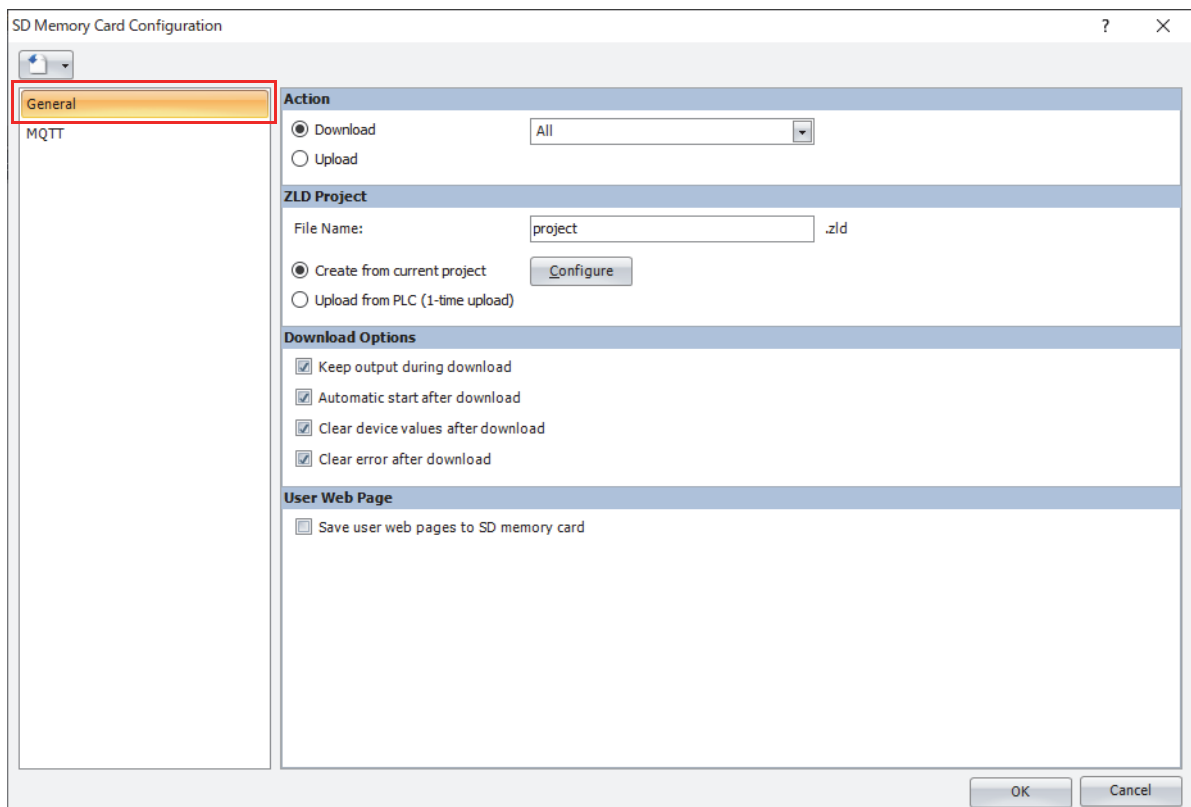

3. Under **Action**, select **Download** and select **ZLD Project**.
4. Under **ZLD Project**, set the file name and creation method of the ZLD file to download.
For the parameter settings, see "General Tab" on page 11-22 for the **SD Memory Card Configuration** dialog box.
5. Set the download options.
For the parameter settings, see "General Tab" on page 11-22 for the **SD Memory Card Configuration** dialog box.
6. Set whether to save user web pages to SD memory card.

11: SD MEMORY CARD

7. Click **OK**.

The **Browse For Folder** dialog box is displayed.

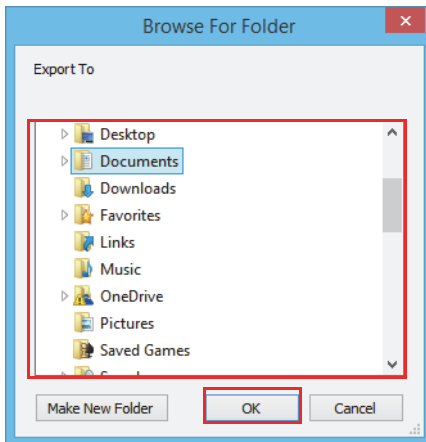

8. Select the drive where the SD memory card is inserted and then click **OK**.

The \FCDATA01\ folder is created on the SD memory card. The autoexec.ini file is saved directly under the \FCDATA01\ folder. If a ZLD file is created from the current project, the ZLD file is saved to the \FCDATA01\PROGRAM\ folder.

This concludes creating an autoexec.ini file.

Note: A standalone ZLD file can be created and edited using WindLDR. For details, see "Creating a ZLD File Using WindLDR" on page 11-33

Creating a ZLD File Using WindLDR

ZLD files are created with the following procedure.

1. Click  (application) > **Save As** > **ZLD Project**.

The **ZLD Project Configuration** dialog box is displayed.

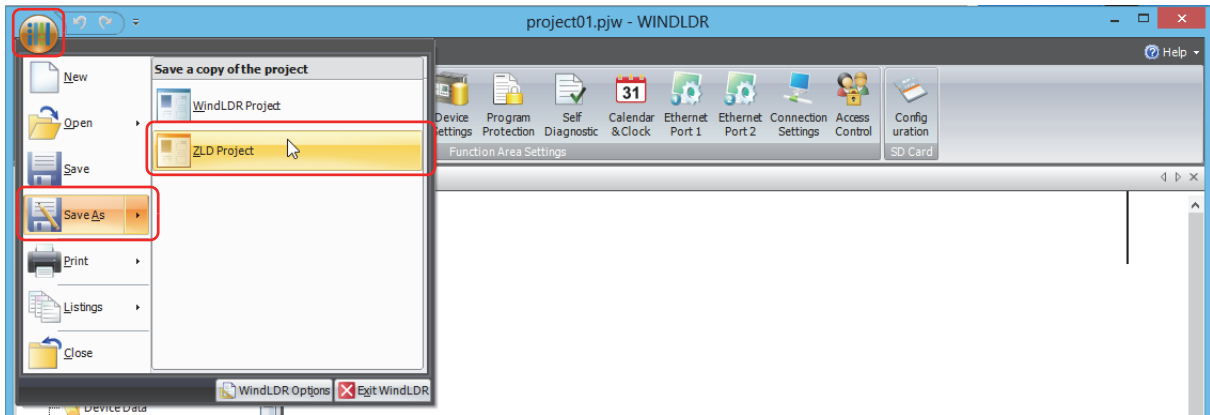

2. Configure the ZLD file details.

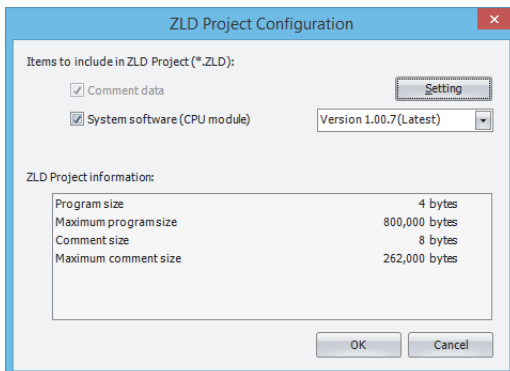

3. Click **OK**.
The **Save As** dialog box is displayed.

11: SD MEMORY CARD

4. Enter the file name in **File name**, specify the folder to save to, and click **Save**.

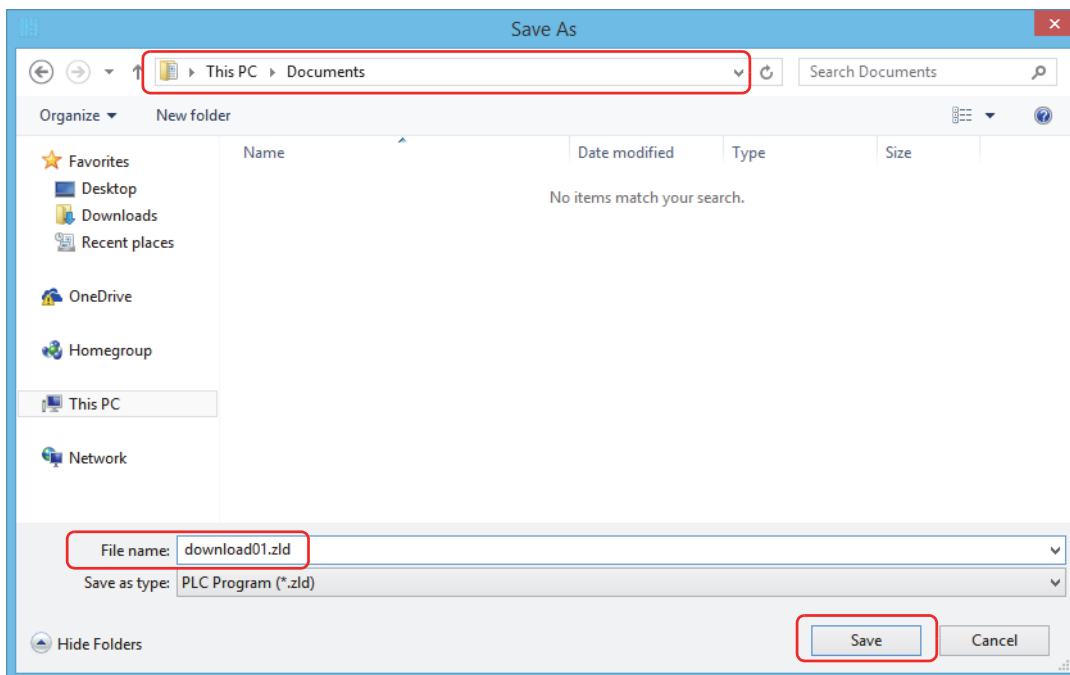

This concludes creating a ZLD file.

ZLD Project Configuration Dialog Box Parameters

This section describes the dialog box parameter settings required to create a ZLD file.

■ ZLD File tab

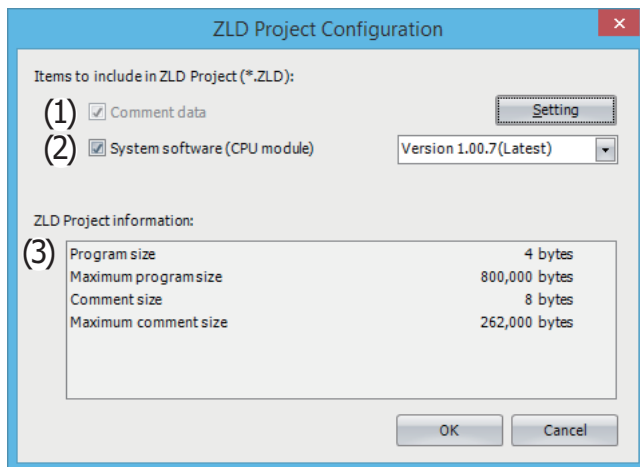

(1) Comment data

Select this check box to include program comments in the ZLD file.

Click **Setting** to display the **Comment Download Settings** dialog box. Select the comments to download and click **OK**. For details on the **Comment Download Settings** dialog box, see "Comment Download Settings dialog box" on page 11-35.

(2) System software (CPU module)

To include the system software in the ZLD file, select this check box and select the version of the system software.

(3) ZLD Project information

This area displays the current user program size, maximum user program size, current comment size, and maximum comment size.

■ Comment Download Settings dialog box

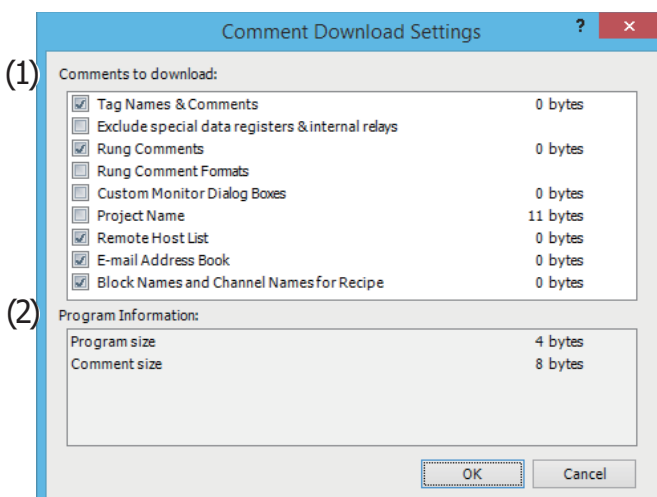

(1) Comments to download

Select the check boxes for comments to download.

(2) Program Information

This area displays the size of the current user program and comments.

11: SD MEMORY CARD

autoexec.ini File Format

The autoexec file is made up of the following three sections.

Section	Description
[COMMON_SETTING]	The section that describes the autoexec.ini file action.
[PROGRAM_DOWNLOAD]	The section that describes the operation when downloading data from the SD memory card.
[PROGRAM_UPLOAD]	The section that describes the operation when uploading data to the SD memory card.

The keys and parameters are described for each section.

If there is no key or if the specified parameter is not applicable, the default value is used for operation.

■ [COMMON_SETTING] section keys and parameters

Key	Description	Parameter		Default Value
		Parameter	Description	
loading_direction	Specifies the autoexec file action.	none	No download or upload is performed.	none
		download	A download is performed from the SD memory card according to the [PROGRAM_DOWNLOAD] section.	
		upload	An upload is performed to the SD memory card according to the [PROGRAM_UPLOAD] section.	

■ [PROGRAM_DOWNLOAD] section keys and parameters

Key	Description	Parameter		Default Value
src_file	Specifies the file name of the ZLD file that will be downloaded from the SD memory card.	Specify the name of a ZLD file in the \FCDATA01\PROGRAM\ folder. <ul style="list-style-type: none"> The file name is enclosed in quotation marks (" "). The file name is a maximum of 128 characters. However, when downloading the CPU module system software, output is turned off regardless of this option's setting.		"download.zld"
auto_start	Specifies the operation status after the download is executed.	true	Set to run after the download is executed.	false
		false	Set to stop after the download is executed.	
clear_data	Specifies whether or not to clear all device data including keep data after the user program download is executed. The data that will be cleared is inputs, outputs, internal relays, shift registers, data registers, timer current values, and counter current values. Timer present values, counter preset values, special internal relays, and special data registers will not be cleared.	true	Clears all device data including keep data after the download is executed.	false
		false	Does not clear all device data including keep data after the download is executed.	
clear_error	Specifies whether or not to clear error information after the download is executed.	true	Clears error information after the download is executed.	false
		false	Does not clear error information after the download is executed.	
auto_upload	Specifies whether or not to use the auto upload function when there is no ZLD file.	true	If the ZLD file specified by src_file does not exist, an upload is executed instead of a download. The file name of the ZLD file to upload is specified by src_file.	false
		false	If the ZLD file specified by src_file does not exist, a download is not executed.	
keep_output	Specifies whether or not to keep output while the user program is downloading.	true	Keeps output while executing the download.	false
		false	Does not keep output while executing the download.	

■ [PROGRAM_UPLOAD] section keys and parameters

Key	Description	Parameter	Default Value
dst_file	Specifies the name of the ZLD file that will be uploaded to the SD memory card.	Specify the name of a ZLD file in the \FCDATA01\PROGRAM\ folder. <ul style="list-style-type: none"> The file name is enclosed in quotation marks (" "). The file name is a maximum of 128 characters. However, when downloading the CPU module system software, output is turned off regardless of this option's setting.	"upload.zld"
filename_option	Specify to dynamically generate the file name.	sn	The file will be created using the serial number of the CPU module instead of the dst_file file name. If the serial number is "12A3456", "12A3456.zld" is created.*1
		none	Creates the file using the name specified by dst_file.

*1 If the CPU module serial number cannot be correctly read, filename_option operates as if none was specified.

Restrictions

- The maximum number of characters per line is 512 single-byte characters including line feed codes. All the text on the line will be ignored if there are more than 512 single-byte characters on the line.
- Each item must be described as a single line. If a line feed occurs before the end of the line, all characters after the line feed are ignored.
- Only line feed codes of the format generally supported by Windows (CR+LF) are supported. If any other line feed format is used, the autoexec.ini file will fail to run properly.
- Data from a semicolon (;) to the line feed code is ignored. The space after the semicolon can be freely used for comments. However, if the autoexec.ini file is opened in WindLDR and then saved again, comments written after the semicolon will be deleted and the file will only contain standard comments.
- Only strings with single-byte characters can be used.
- If the same key appears multiple times, only the bottom key is valid.

11: SD MEMORY CARD

■ autoexec.ini file example

```
[COMMON_SETTING]
;; loading_direction
;; "download" : download to PLC, with [PROGRAM_DOWNLOAD] section's settings.
;; "upload" : upload to SD card, with [PROGRAM_UPLOAD] section's settings.
;; "none" : no operation, ignore both [PROGRAM_DOWNLOAD] and [PROGRAM_UPLOAD] sections' settings.
loading_direction=download

[PROGRAM_DOWNLOAD]
;; src_file
;; zld file's name for download in \FCDATA01\PROGRAM\ folder.
src_file="download.zld"

;; auto_start
;; "true" : start PLC after downloading user program.
;; "false" : keep stop PLC after downloading user program.
auto_start=false

;; clear_data
;; "true" : clear all devices' data includes keep data after downloading user program.
;; "false" : not clear all devices' data includes keep data after downloading user program.
clear_data=false

;; clear_error
;; "true" : clear error status after downloading user program.
;; "false" : not clear error status after downloading user program.
clear_error=false

;; auto_upload
;; "true" : upload alternatively, if not exist ZLD file pointed by 'src_file' when downloading.
;; "false" : do nothing, if not exist ZLD file pointed by 'src_file' when downloading.
auto_upload=false

;; keep_output
;; "true" : keep output while downloading the user program.
;; "false" : not keep output while downloading the user program.
keep_output=false

[PROGRAM_UPLOAD]
;; dst_file
;; zld file's name for upload into \FCDATA01\PROGRAM\ folder.
dst_file="upload.zld"

;; filename_option
;; name zld file automatically
;; "sn" : use serial number of CPU module as zld filename for uploading
;; "none" : use 'dst_file' as zld filename for uploading
filename_option=none
```

Creating the mqtt_basic_settings.ini File

To download the files for MQTT Basic Settings to the Plus CPU module using an SD memory card, save the mqtt_basic_settings.ini and certificates (der format) to the SD memory card.

Note: The mqtt_basic_settings.ini file is created according to the file format described in this section. By using WindLDR, the mqtt_basic_settings.ini file can be created by configuring a dialog box and without needing to be aware of the file format. To create the mqtt_basic_settings.ini file using Notepad or another text editor, type in the sections, keys, and parameters according to the file format and save the file as "mqtt_basic_settings.ini".

Creating the mqtt_basic_settings.ini File Using WindLDR

This section describes the procedure to create an mqtt_basic_settings.ini file using WindLDR.

• **Operation procedure**

1. On the **MQTT Settings** tab in the **MQTT Settings** dialog box, select the **Enable MQTT** and **Specify with SD memory card** check boxes.
2. Configure the other necessary settings, and then click **OK**.
The **MQTT Settings** dialog box is closed.
3. On the **Configuration** tab, in the **SD Card** group, select **Configuration**.
The **SD Memory Card Configuration** dialog box is displayed.

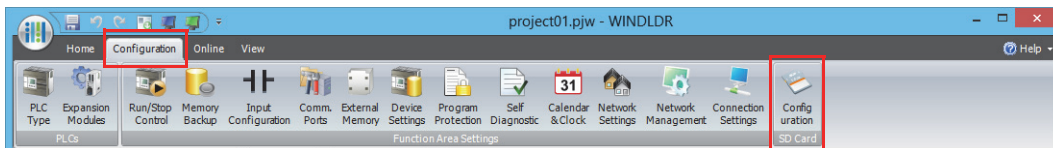

4. Under **Action**, select **Download** and select **MQTT Basic Settings**.
5. Click the **MQTT** tab.

Set the contents of the mqtt_basic_settings.ini file on this tab.

For the parameter settings, see "MQTT Tab" on page 11-25 for the **SD Memory Card Configuration** dialog box.

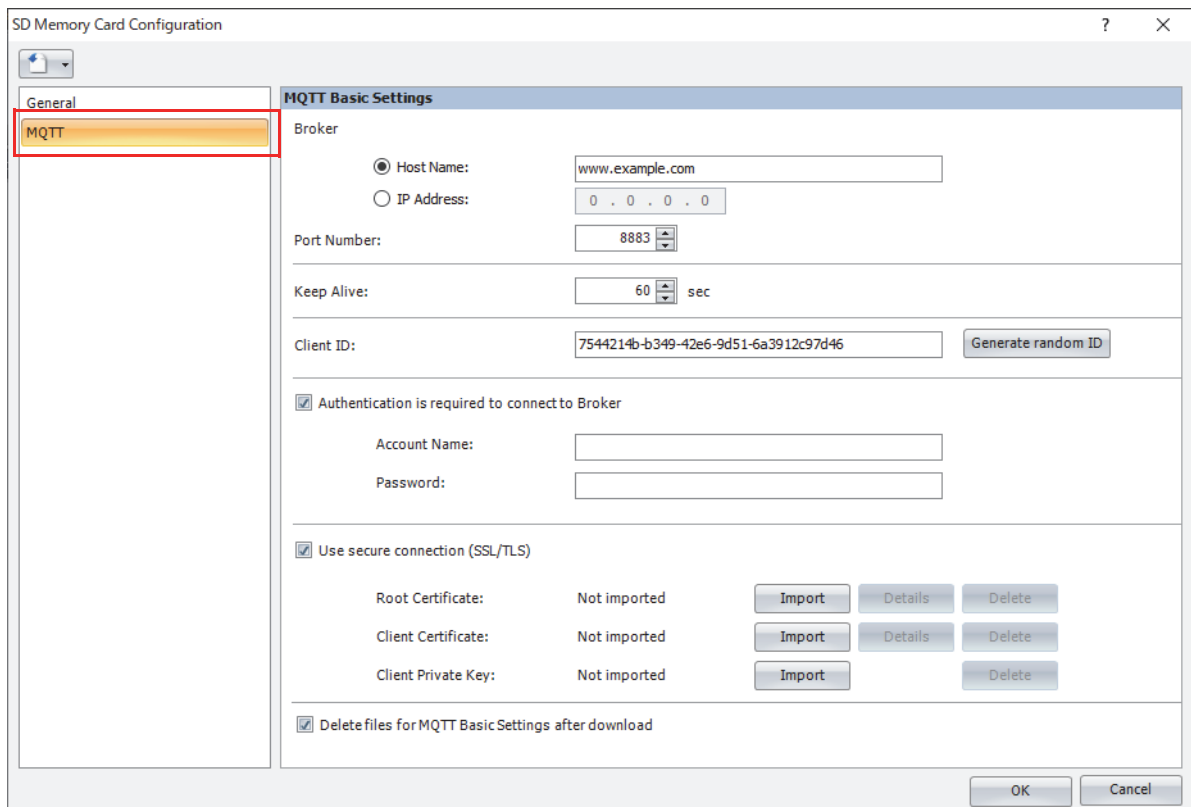

11: SD MEMORY CARD

6. Click **OK**.

The **Browse For Folder** dialog box is displayed.

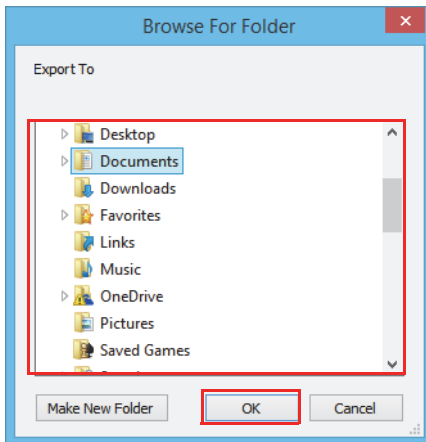

7. Select the drive where the SD memory card is inserted and then click **OK**.

The \FCDATA01\ folder is created on the SD memory card. The mqtt_basic_settings.ini file is saved directly under the \FCDATA01\ folder. The root certificate, client certificate, and client private key are saved in the \FCDATA01\TLS\ folder.

This concludes creating the mqtt_basic_settings.ini file.

mqtt_basic_settings.ini File Format

The mqtt_basic_settings.ini file is made up of the following six sections.

Section	Description
[MQTT_BROKER]	The section that describes the host name and port number of the broker.
[MQTT_KEEP_ALIVE]	The section that describes the keep alive.
[MQTT_CLIENT_ID]	The section that describes the client ID.
[MQTT_AUTH]	The section that describes settings for authentication when connecting to the broker.
[MQTT_TLS]	The section that describes settings for performing TLS communication with the broker.
[MQTT_DELETE_FILES]	The section that describes whether to delete files in the TLS folder created on the SD memory card after the download.

■ [MQTT_BROKER] section keys and parameters

Key	Description	Parameter	Default Value
hostname	Specifies the host name or IP address of the broker.	Host Name	"www.example.com"
		IP Address	
port_number	Specifies the port number.	Specify the port number between 0 and 65535 without enclosing it in quotation marks (" ").	1883

■ [MQTT_KEEP_ALIVE] section keys and parameters

Key	Description	Parameter	Default Value
keep_alive	Specifies the keep alive.	Specify the keep alive between 5 and 65535 s without enclosing it in quotation marks (" ").	60

■ [MQTT_CLIENT_ID] section keys and parameters

Key	Description	Parameter	Default Value
client_id	Specifies the client ID.	<ul style="list-style-type: none"> The client ID is enclosed in quotation marks (" "). The maximum length of the client ID is 128 characters. 	Random string

■ [MQTT_AUTH] section keys and parameters

Key	Description	Parameter	Default Value
authentication	Specifies the setting for authentication when connecting to the broker.	true	false
		false	
accountname	Specifies the account name.	<ul style="list-style-type: none"> The account name is enclosed in quotation marks (" "). The maximum length of the account name is 128 characters. 	Blank
password	Specifies the password.	<ul style="list-style-type: none"> The password is enclosed in quotation marks (" "). The maximum length of the password is 496 characters. 	Blank

■ [MQTT_TLS] section keys and parameters

Key	Description	Parameter		Default Value
use_secure_connection	Specifies whether to perform SSL communication with the broker.	true	Performs TLS communication with the broker.	false
		false	Does not perform TLS communication with the broker.	
root_certificate	Specifies whether there is a root certificate of the server certificate.	true	There is a root certificate of the server certificate.	false
		false	There is no root certificate of the server certificate.	
client_certificate	Specifies whether there is a client certificate.	true	There is a client certificate.	false
		false	There is no client certificate.	
client_private_key	Specifies whether there is a client private key.	true	There is a client private key.	false
		false	There is no client private key.	

■ [MQTT_DELETE_FILES] section keys and parameters

Key	Description	Parameter		Default Value
delete_files	Specifies whether to delete the files for MQTT Basic Settings after the download.	true	Deletes the files for MQTT Basic Settings.	false
		false	Does not delete the files for MQTT Basic Settings.	

Restrictions

- The maximum number of characters per line is 512 single-byte characters including line feed codes. All the text on the line will be ignored if there are more than 512 single-byte characters on the line.
- Each item must be described as a single line. If a line feed occurs before the end of the line, all characters after the line feed are ignored.
- Only line feed codes of the format generally supported by Windows (CR+LF) are supported. If any other line feed format is used, the mqtt_basic_settings.ini file will fail to run properly.
- Data from a semicolon (;) to the line feed code is ignored. The space after the semicolon can be freely used for comments. However, if the mqtt_basic_settings.ini file is opened in WindLDR and then saved again, comments written after the semicolon will be deleted and the file will only contain standard comments.
- Only strings with single-byte characters can be used.
- If the same key appears multiple times, only the bottom key is valid.

■ mqtt_basic_settings.ini file example

```
[MQTT_BROKER]
hostname="www.example.com"
port_number=8883
[MQTT_KEEP_ALIVE]
keep_alive=60
[MQTT_CLIENT_ID]
client_id="device0"
[MQTT_AUTH]
authentication=true
accountname="idec"
password="password"
[MQTT_TLS]
use_secure_connection=true
root_certificate=true
client_certificate=true
client_private_key=true
[MQTT_DELETE_FILES]
delete_files=true
```

Upload to SD Memory Card

The user program and system software written to the CPU module can be uploaded to the SD memory card.

Upload a ZLD File

The user programs and system software written to the CPU module can be uploaded to the SD memory card.

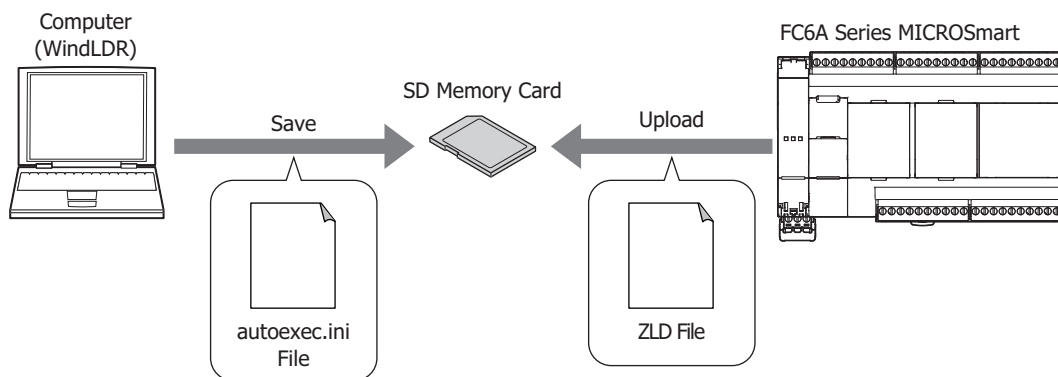

Data can be uploaded while the CPU module is running.

By performing the following operations, the CPU module's user program and system software can be uploaded to the SD memory card as a ZLD file.

Operation	Action	When the CPU Module is Read Protected
<p>The CPU module power is turned on when an SD memory card with an autoexec.ini file that executes an upload has been inserted in the SD memory card slot.</p> <p>Special internal relay M8251 is turned on when an SD memory card with an autoexec.ini file that executes an upload has been inserted in the SD memory card slot.</p> <p>An SD memory card with an autoexec.ini file that executes an upload is inserted in the SD memory card slot.</p>	<p>The data is uploaded from the CPU module with the ZLD file name specified by the autoexec.ini file.</p> <p>The ZLD file is uploaded to the \FCDATA01\PROGRAM\ folder.</p>	<p>The upload is not performed.</p>
<p>An upload is executed with the system menu on the HMI module.</p> <p>For details, see "Uploading the User Program (CPU module → SD memory card)" on page 7-46.</p>	<p>The data is uploaded with the file name specified by the system menu on the HMI module.</p> <p>The ZLD file is uploaded to the \FCDATA01\PROGRAM\ folder.</p> <ul style="list-style-type: none"> The upload is executed even if there is no autoexec.ini file on the SD memory card. Even if there is an autoexec.ini file on the SD memory card, it will not be read. For details, see "Creating the autoexec.ini File" on page 11-31. 	<p>The upload is performed if the password matches the password entered with the HMI module.</p> <p>The upload is not performed if the passwords do not match.</p>

An upload is not performed for data that has not been written to the CPU module. If a ZLD file that contains the same data as the CPU module data already exists on the SD memory card, it will not be overwritten by the upload. If any of the data is different, all of the data will be uploaded and the file will be overwritten with a new ZLD file.

11: SD MEMORY CARD

Example 1: When there is no ZLD file on the SD memory card
All data will be uploaded and a ZLD file will be created.

Upload	CPU Module Data	Data Stored in the ZLD File on the SD Memory Card	ZLD File Data on the SD Memory Card after Upload
CPU Module System Software	Ver1.30	None (No ZLD file on the SD memory card)	Ver1.30
User program	Project1		Project1
Program comments	Comment1		Comment1

Example 2: When the system software versions are different
The ZLD file will be overwritten with a new ZLD file.

Upload	CPU Module Data	Data Stored in the ZLD File on the SD Memory Card	ZLD File Data on the SD Memory Card after Upload
CPU Module System Software	Ver1.30	Ver1.23	Ver1.30
User program	Project1	Project1	Project1
Program comments	Comment1	Comment1	Comment1

Example 3: When the user program and program comments are different
The ZLD file will be overwritten with a new ZLD file.

Upload	CPU Module Data	Data Stored in the ZLD File on the SD Memory Card	ZLD File Data on the SD Memory Card after Upload
CPU Module System Software	Ver1.30	Ver1.30	Ver1.30
User program	Project2	Project1	Project2
Program comments	Comment2	Comment1	Comment2

Used Special Devices

Download and Upload a ZLD File

The special internal relays and the special data registers used by uploads and downloads that use the SD memory card are as follows.

Note: R/W stands for read/write and allows reading and writing. R is read-only. W is write-only.

Special Internal Relays

Device Address	Function	Description	R/W
M8250	Download from SD Memory Card Execution Flag	When M8250 is turned on, a ZLD file is downloaded from the SD memory card. The file that will be downloaded is the ZLD file specified in the autoexec.ini file.	R/W
M8251	Upload to SD Memory Card Execution Flag	When M8251 is turned on, a ZLD file is uploaded to the SD memory card. A ZLD file is created with the file name specified in the autoexec.ini file.	R/W
M8252	Executing SD Memory Card Download	M8252 is turned on when starting execution of the download from the SD memory card, and when the download has completed, it is turned off.	R
M8253	Executing SD Memory Card Upload	M8253 is turned on when starting execution of the upload to the SD memory card, and when the upload has completed, it is turned off.	R
M8254	SD Memory Card Download/Upload Execution Completed Output	M8254 is turned off when starting execution of the download from the SD memory card or the upload to the SD memory card, and when the download or upload has completed, it is turned on.	R
M8255	SD Memory Card Download/Upload Execution Error Output	M8255 is updated when execution of the download from the SD memory card or the upload to the SD memory card has completed. M8255 is turned off when the SD memory card download or upload has normally ended or when the user program was not uploaded or downloaded. M8255 is turned on when an error occurs during the SD memory card download or upload. For details, see "D8255: SD Memory Card Download/Upload Execution Error Information" on page 11-46.	R

Special Data Registers

Device Address	Function	Description	R/W
D8254	SD Memory Card Download/Upload Execution Information	Information about the SD memory card download/upload that was executed. For details, see "D8254: SD Memory Card Download/Upload Execution Status" on page 11-45.	R
D8255	SD Memory Card Download/Upload Execution Status	The status of the SD memory card download/upload that was executed. For details, see "D8255: SD Memory Card Download/Upload Execution Error Information" on page 11-46.	R

■ D8254: SD Memory Card Download/Upload Execution Status

The allocation of bits in the device (bit assignment) is as follows.

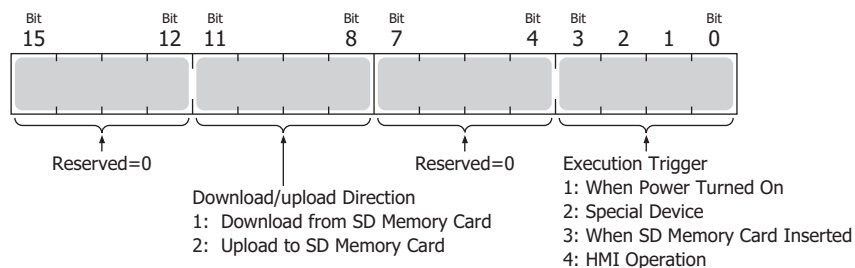

11: SD MEMORY CARD

■ D8255: SD Memory Card Download/Upload Execution Error Information

Status	Download	Upload	M8255
0	Normal termination	Normal termination	OFF
1	No SD memory card is inserted.	No SD memory card is inserted.	ON
2	—	The SD memory card is write protected.	ON
3	Invalid SD memory card format.	Invalid SD memory card format.	ON
4	—	The SD memory card is full and no folders or files can be created.	ON
5	The ZLD file name specified by src_file is invalid.* ¹	The ZLD file name specified by dst_file is invalid.* ¹	OFF
6	Failed to read the ZLD file saved to the SD memory card.* ²	Failed to write the ZLD file to the SD memory card.* ²	OFF
7	No ZLD file on the SD memory card.	—	ON
8	—	A program syntax error occurred and the ZLD file could not be created.	ON
9	<ul style="list-style-type: none"> No autoexec.ini file. The autoexec.ini could not be read. 	<ul style="list-style-type: none"> No autoexec.ini file. The autoexec.ini could not be read. 	ON
10	The program download is password protected* ³ .	The program upload is password protected* ³ .	ON
11	—	—	—
12	The ZLD file saved on the SD memory card has an invalid file size.	—	ON
13	The target model of the ZLD file saved on the SD memory card is different.	—	ON
14	Other download processing is being executed.	—	ON
15	The download was not executed because the user program written to the FC6A Series MICROSmart was the same as the data in the ZLD file saved to the SD memory card.	—	OFF
16	The download was not executed because the system software and user program written to the FC6A Series MICROSmart was the same as the data in the ZLD file saved to the SD memory card.	The download was not executed because the system software and user program written to the FC6A Series MICROSmart was the same as the data in the ZLD file saved to the SD memory card.	OFF

*1 Double-byte characters and the single-byte characters ¥ / : , ; * ? " < > | cannot be used in the file name.

*2 When file data cannot be normally written or read due to the data in the file becoming corrupted or a failure of a specific area of the SD memory card.

*3 Except when the password has been canceled using the HMI module.

Download files for MQTT Basic Settings

The special internal relays and the special data registers used to download the files for MQTT Basic Settings are as follows.

Note: R/W stands for read/write and allows reading and writing. R is read-only. W is write-only.

Special Internal Relay

Address	Description		R/W
M8271	Download MQTT Basic Settings from SD Memory Card Execution Flag	When M8271 is turned on, the files for MQTT Basic Settings are downloaded.	R/W
M8272	Download MQTT Basic Settings from SD Memory Card Execution Completion Output	M8272 is turned off when downloading the files for MQTT Basic Settings is started, and it is turned on once the download is finished.	R
M8273	Download MQTT Basic Settings from SD Memory Card Error Output	M8273 is turned off when downloading the files for MQTT Basic Settings is started. It is turned on if an error occurs during the process.	R

Special Data Registers

Address	Description		R/W
D8256	Download MQTT Basic Settings from SD Memory Card Execution Information	Information in executing the download of the files for MQTT Basic Settings. For details, see "D8256: Download MQTT Basic Settings from SD Memory Card Execution Information" on page 11-47.	R
D8257	Download MQTT Basic Settings from SD Memory Card Execution Error Information	Error information in executing the download of the files for MQTT Basic Settings. For details, see "D8257: Download MQTT Basic Settings from SD Memory Card Execution Error Information" on page 11-47.	R

■ D8256: Download MQTT Basic Settings from SD Memory Card Execution Information

The allocation of bits in the device (bit assignment) is as follows.

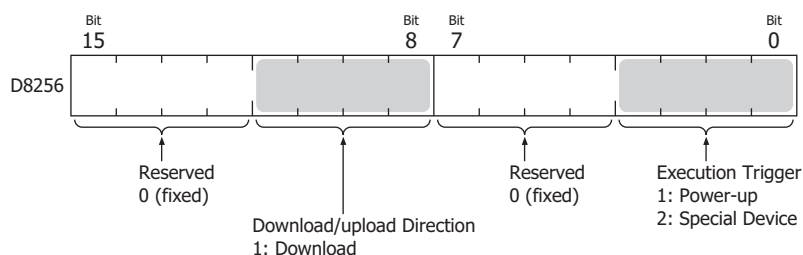

■ D8257: Download MQTT Basic Settings from SD Memory Card Execution Error Information

D8257 (Error Code)	Description	M8273	ROM Status
0	Normal termination	OFF	Refreshed
1	M8271 (Download MQTT Basic Settings from SD Memory Card Execution Flag) was turned on when an SD memory card was not inserted.	ON	Not refreshed
2	The SD memory card is write protected.	ON	Not refreshed
3	Invalid SD memory card format.	ON	Not refreshed
4	M8271 (Download MQTT Basic Settings from SD Memory Card Execution Flag) was turned on when there is no mqtt_basic_settings.ini file on the SD memory card.	ON	Not refreshed
5	In the mqtt_basic_settings.ini file, root_certificate=true was set, but there is no mqtt_root_certificate.der file on the SD memory card or reading the file failed.*1	ON	Not refreshed
6	In the mqtt_basic_settings.ini file, client_certificate=true was set, but there is no mqtt_client_certificate.der file on the SD memory card or reading the file failed.*1	ON	Not refreshed
7	In the mqtt_basic_settings.ini file, client_private_key=true was set, but there is no mqtt_private_key.der file on the SD memory card or reading the file failed.*1	ON	Not refreshed
8	Attempted to save mqtt_root_certificate.der file to the SD memory card, but the file size is invalid.	ON	Not refreshed
9	Attempted to save mqtt_client_certificate.der file to the SD memory card, but the file size is invalid.	ON	Not refreshed
10	Attempted to save mqtt_private_key.der file to the SD memory card, but the file size is invalid.	ON	Not refreshed
11	Writing the files for MQTT Basic Settings failed.	ON	Undefined
12	Reading the mqtt_basic_settings.ini file failed.*1	ON	Not refreshed

*1 Status when the data in the files for MQTT Basic Settings cannot be read properly from the SD memory card for a reason such as an error in the data in the files for MQTT Basic Settings or a specific area on the SD memory card has malfunctioned.

SD Memory Card Maintenance with Data File Manager

The following operations can be performed on the SD memory card inserted in the FC6A Series MICROSmart by using Data File Manager.

- Display file list
- Download files and folders
- Upload files and folders
- Delete files and folders
- Format SD memory card

These operations are called SD memory card maintenance. To use SD memory card maintenance, connect the FC6A Series MICROSmart to a PC with either of the following methods.

- Connect the FC6A Series MICROSmart and a PC using a USB cable.

Example of using the USB port

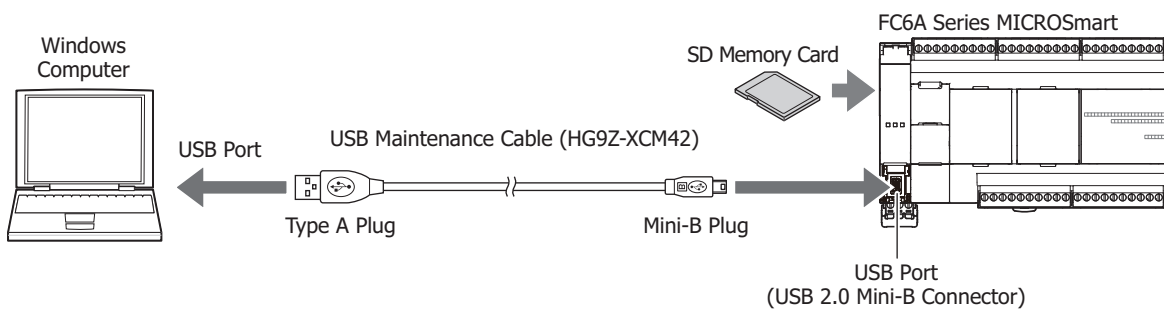

- Connect the FC6A Series MICROSmart and a PC over Ethernet.

Example of using Ethernet Port 1

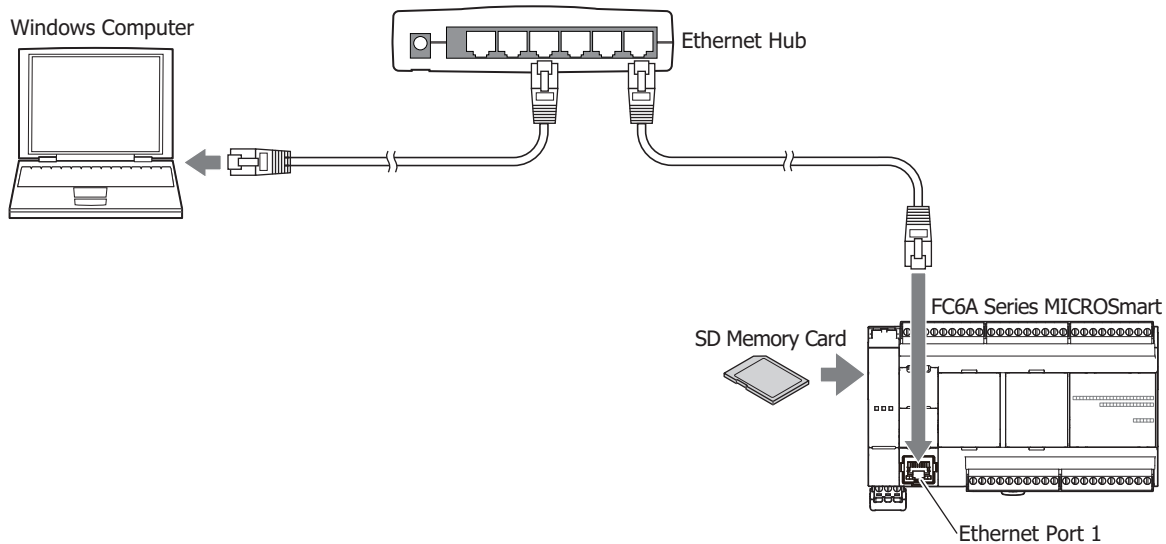

Notes:

- Data File Manager uses the maintenance communication protocol, so it will not operate if the environment cannot perform maintenance communication (for example, with Ethernet communication, communication is not possible if the port numbers are different).
- The operating speed varies according to the communication status with the FC6A Series MICROSmart and the capacity of the SD memory card.
- The basic SD memory card and file system restrictions are the same as the restrictions for the DLOG instruction and the TRACE instruction.
- Device Manager functions other than SD memory card maintenance can be used with serial communication over Serial Port 1 or a communication cartridge. For details, see "Other Data File Manager Functions" on page 11-57.
- SD memory card maintenance using the Data File Manager can also be done with the command line. You can download the files for MQTT Basic Settings with the command line. For details, refer to "Chapter 4 Command Line" of Data File Manager User's Manual.

Starting and Exiting Data File Manager

■ Starting Data File Manager

When a CPU module with an inserted SD memory card is connected to a PC, Data File Manager can be started for editing.

1. On the **Online** tab, in the **PLC** group, click **Maintenance** and then **Data File Manager**.

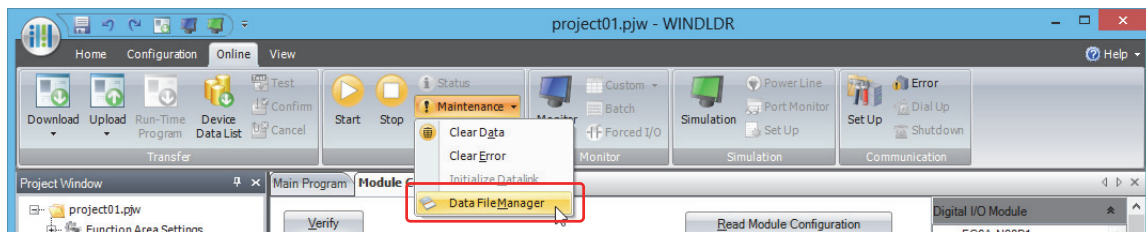

Notes:

- A connection cannot be made using the pass-through function. Clear the **Use HGxG Pass-Through** check box.
- A connection cannot be made using the maintenance function over Modbus TCP. When the communication method is **Serial**, clear the **Use maintenance communication over Modbus TCP** check box.
- Data File Manager can be opened independently without starting WindLDR. The procedure to open Data File Manager independently is as follows.
 - Windows 10
Click **Start** and then **All Apps > IDEC Automation Organizer > Data File Manager**.
 - Windows 8
Click **Data File Manager** in the tiles on the Start screen.
 - Windows 7
Click **Start > Programs > IDEC Automation Organizer > Data File Manager**.
- The standalone Data File Manager application can be downloaded from the IDEC homepage (at the following URL) free of charge.
<http://jp.idec.com/ja/download/search.aspx?category=&tab=software>

Data File Manager starts.

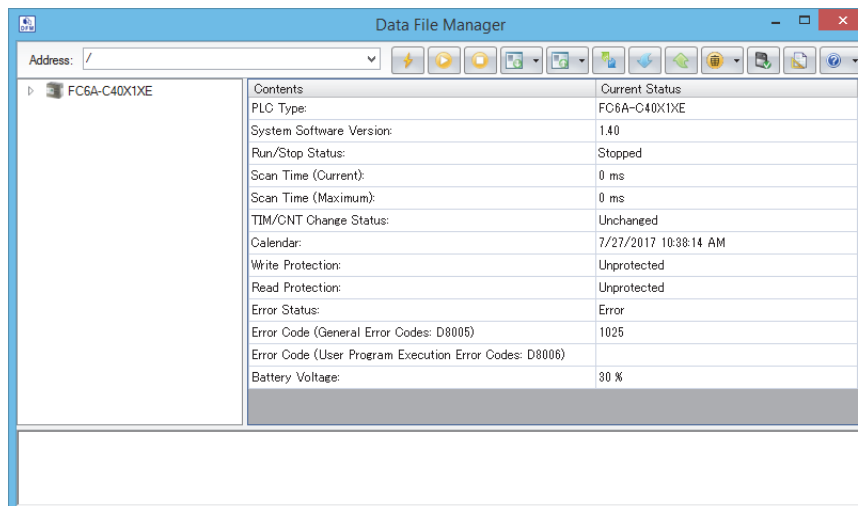

11: SD MEMORY CARD

Exiting Data File Manager

1. Click **X** at the upper-right corner of Data File Manager.
Data File Manager exits.

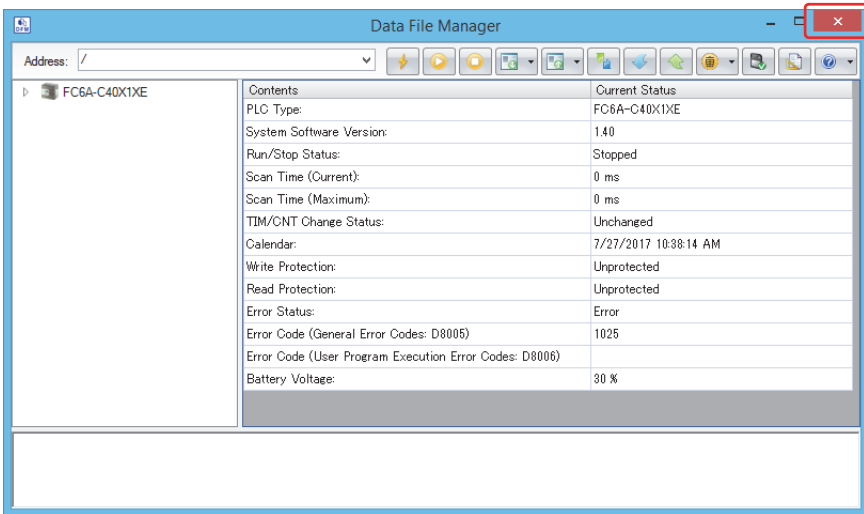

SD Memory Card Maintenance

Display file list

Data File Manager acquires the list of files and folders from the SD memory card inserted in the FC6A Series MICROSmart and displays them in a tree view (1) and a folder details view (2).

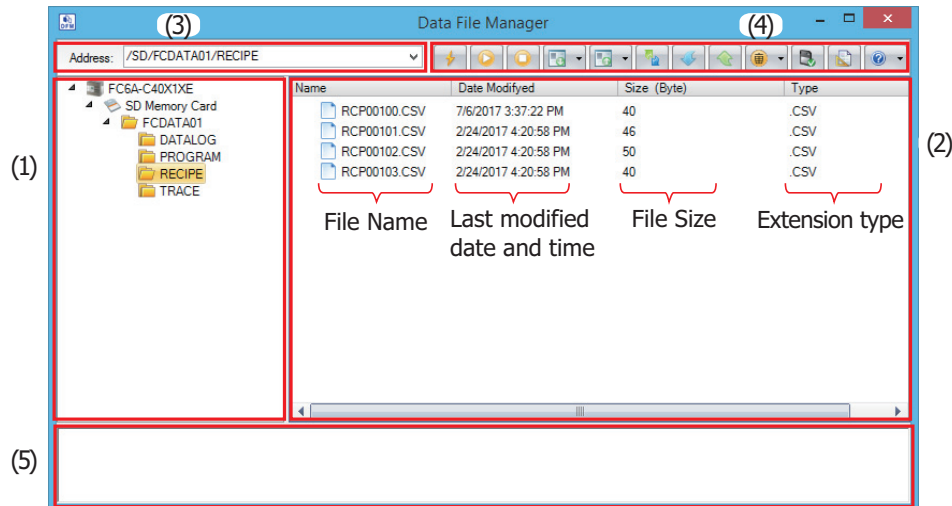

(1) Tree view

Displays the folder structure as a tree. Double-click a folder to move to the level in that folder (up or down).

1st level (root) : Displays the connected FC6A Series MICROSmart as an icon and a string.

2nd level : Displays the connected FC6A Series MICROSmart SD memory card as an icon and a string.

3rd level and lower: Displays the SD memory card folders as a tree.

(2) Folder details view

Displays a list of the files and folders in the folder selected on the tree view.

Displayed files and folder can be renamed and new folders can be created.

To rename files and folders

Select a file or folder and select **Rename** on the right-click menu or press the **F2** key. It will then be possible to edit the name, so rename the file or folder.

To create a folder

Click **Create Folder** on the right-click menu or click **Create Folder**. The **Create Folder** dialog box is displayed. Enter the name and click **OK**.

(3) Address field

Displays the path of the folder selected in the tree view from the 3rd level and lower.

However, when the CPU module and PC are connected over Ethernet, the IP address and port number are displayed at the beginning of the path.

When connected to the PC over USB

/SD memory card name/folder path

Example: /SD/FCDATA01/

When connected to the PC over Ethernet

IP address:port number/SD memory card name/folder path

Example: 192.168.1.100:80/SD/FCDATA01/

11: SD MEMORY CARD

(4) Toolbar

Button	Command	Description	
	Connect	The Connection Settings dialog box is displayed.	
	Start	Changes the FC6A Series MICROSmart status from stop to run.	
	Stop	Changes the FC6A Series MICROSmart status from run to stop.	
	Download	ZLD project file (.zld) saved in the computer can be downloaded to the CPU module.	
		Download ZLD project file (.zld)	The same behavior with when Download icon is clicked.
		Download system software	The system software of FC6A Series MICROSmart can be updated.
		Download file	Files stored in the computer can be downloaded to the SD memory card inserted in FC6A Series MICROSmart.
	Upload	Folder stored in the computer can be downloaded to the SD memory card inserted in FC6A Series MICROSmart.	
		Upload ZLD project file (.zld)	The user program stored in the CPU module can be saved in the computer as a ZLD project file (.zld).
		Upload file/folder	The same behavior with when Upload icon is clicked.
	Refresh	Files and folders shown in the folder details view can be saved in the computer.	
	Download device address data (.csv)	The latest status is acquired from the CPU module and the view is updated.	
	Upload device address data (.csv)	Device address data (.csv) that is stored in the computer can be written to the device addresses of the connected target.	
	Clear	The values of the device addresses of FC6A Series MICROSmart can be read and saved in the computer as a csv file.	
		Clear values in all device addresses	Device values stored in the internal memory of FC6A Series MICROSmart can be cleared. Types of the devices that are cleared are as follows: inputs, outputs, internal relays, shift registers, data registers, timer current values, and counter current values.
	Clear Error	Error information stored in the internal memory of FC6A Series MICROSmart can be cleared.	
	Format SD memory card	SD memory card inserted in FC6A Series MICROSmart can be formatted.	
	Option	Optional functions of Data File Manager can be configured.	
	Help	Help for Data File Manager is displayed.	
		Help	The same behavior with when Help icon is clicked.
		About Data File Manager	About Data File Manager dialog box is displayed.

(5) Execution log view

The operation log is displayed by executing the following operations.

Operation	Description	Log format
Delete	Displays the number of files that were successfully deleted and the number of files that failed to be deleted.	Delete Success: {0} file(s), Failed: {1} file(s)
Upload	Displays the number of files that were successfully uploaded and the number of files that failed to be uploaded.	Upload Success: {0} file(s), Failed: {1} file(s)
Download	Displays the number of files that were successfully downloaded and the number of files that failed to be downloaded.	Download Success: {0} file(s), Failed: {1} file(s)

Run/stop operations using Data File Manager

The FC6A Series MICROSmart can be set to run or stop using Data File Manager operations.

• Run procedure

- Click the toolbar button.
A confirmation message is displayed.
- Click **Yes**.

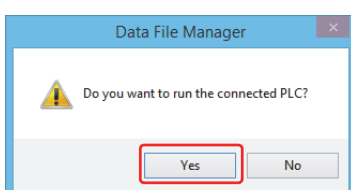

This concludes the run operation using Data File Manager.

• **Stop procedure**

1. Click the toolbar  button.
A confirmation message is displayed.
2. Click **Yes**.

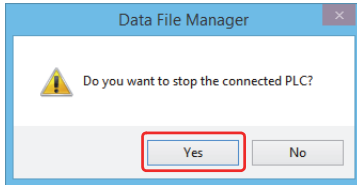

This concludes the stop operation using Data File Manager.

Download files and folders

Files and folders saved on the PC will be written to the SD memory card inserted in the FC6A Series MICROSmart.

• **Operation procedure to download a file**

1. Select the target folder for the download in the Tree View.

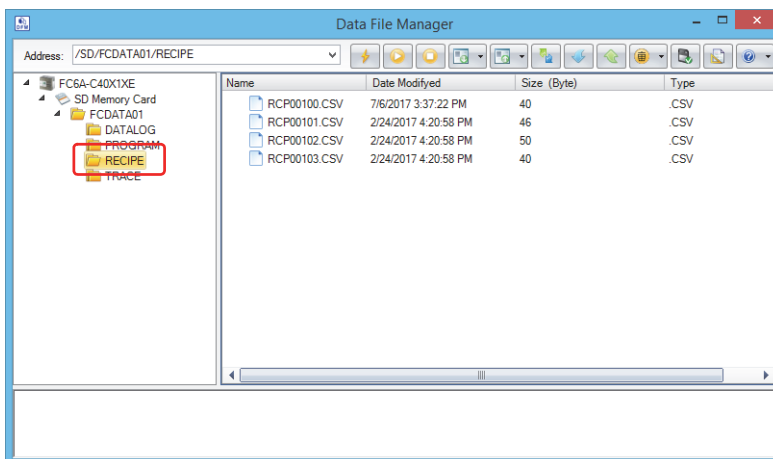

2. Click on the down-pointing triangle button on the right of the  (Download) button and click **Download File**.
The **Open** dialog box is displayed.
3. Select the files to download and click **Open**.
The download starts.

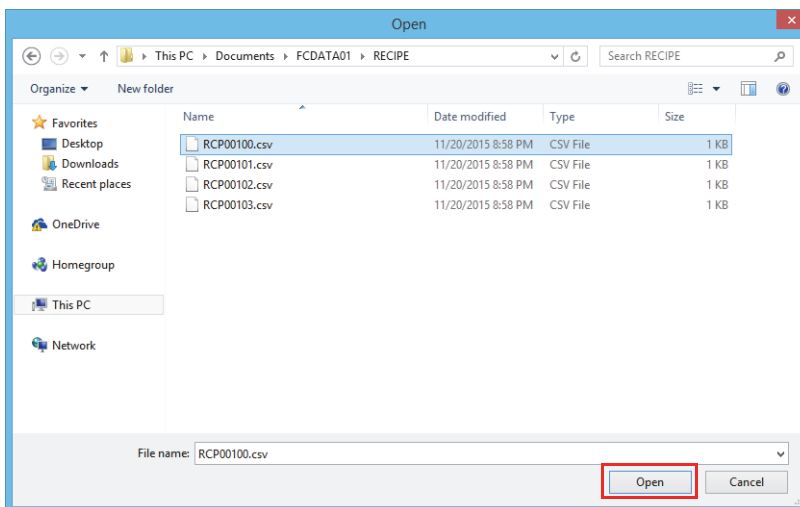

This concludes downloading files.

Note: The selected files can be downloaded by selecting files in Explorer of the PC and dragging and dropping them into the folder detailed view.

11: SD MEMORY CARD

• Operation procedures to download a folder

1. Select the target folder for the download in the Tree View.

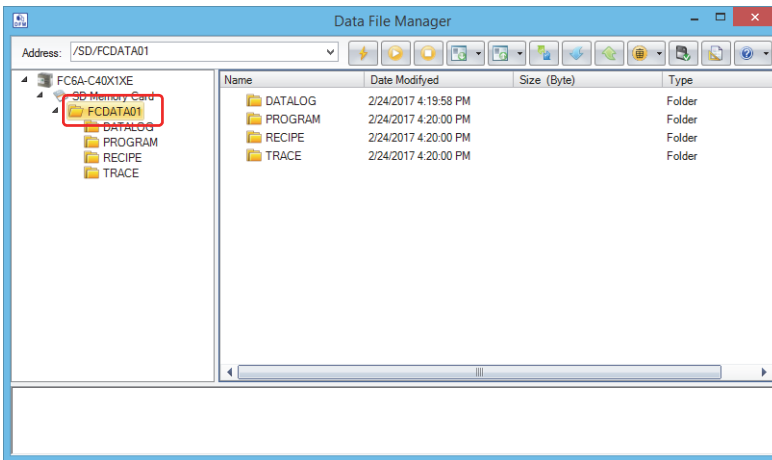

2. Click on the down-pointing triangle button on the right of the  (Download) button and click **Download Folder**. The **Browse For Folder** dialog box is displayed.
3. Select the folder to download and click **Open**. The download starts.

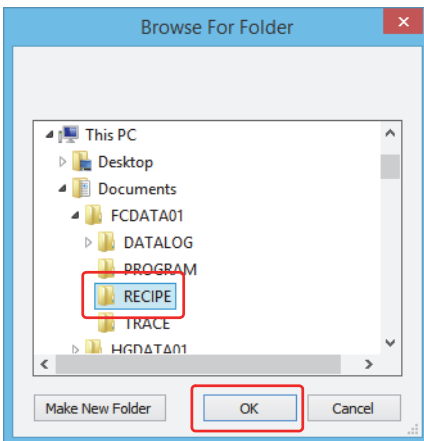

This concludes downloading folders.

Note: The selected folder can be downloaded by selecting folder in Explorer of the PC and dragging and dropping it into the folder detailed view.

Upload files and folders

Files and folders displayed in the folder details view will be saved to the PC.

1. Select the files and folders to upload in the folder details view.

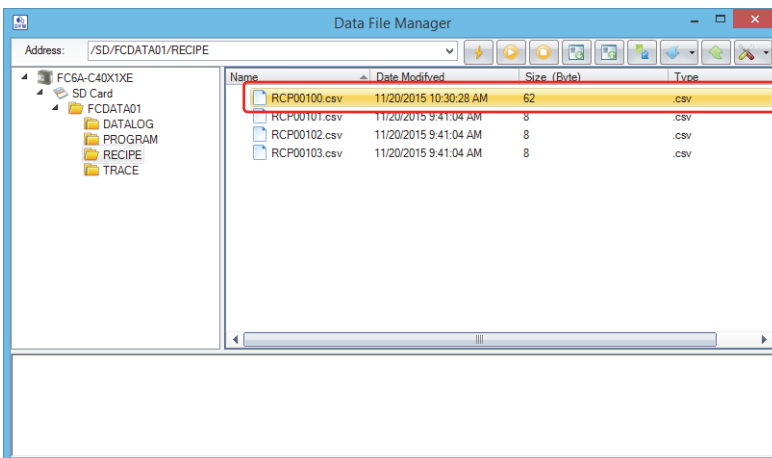

2. Click on the down-pointing triangle button on the right of the  (Upload) button and click Upload File/Folder. The **Browse For Folder** dialog box is displayed.
3. Select the destination and then click **OK**. The upload starts.

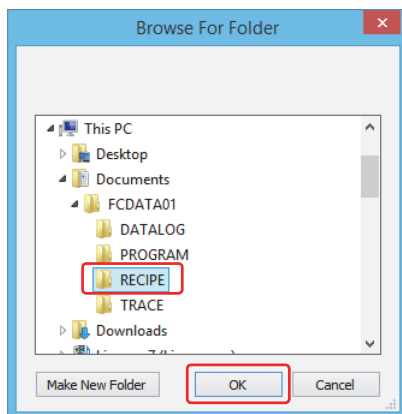

This concludes uploading files and folders.

Note: The selected files/folders can be uploaded by selecting folder in the folder detailed view and dragging and dropping them into the Explorer of the PC.

11: SD MEMORY CARD

Delete files and folders

Files and folders displayed in the folder details view will be deleted.

Operation Procedures

1. Select a file or folder in the folder details view and select **Delete** on the right-click menu or press the **Delete** key.
A delete confirmation message is displayed.

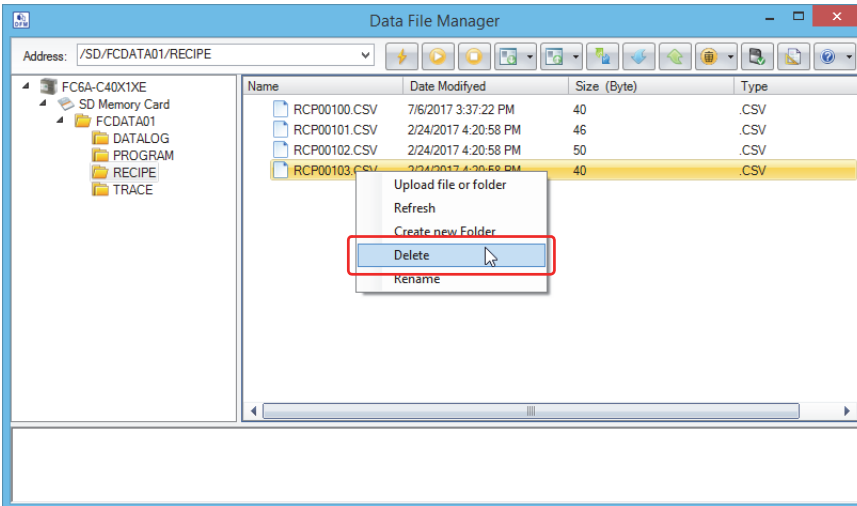

2. Click **Yes**.

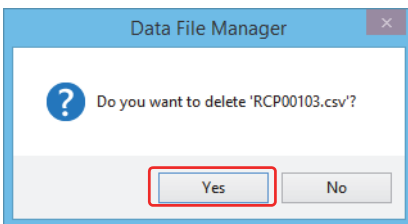

This concludes deleting files and folders.

Formatting the SD Memory Card

The SD memory card inserted in the FC6A Series MICROSmart will be formatted.

1. Click  (Format SD Memory Card) on the toolbar.
A format confirmation message is displayed.
2. Click **Yes**.
The format is executed.

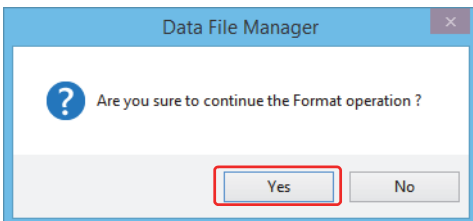

This concludes formatting the SD memory card.

Note: Formatting the SD memory card on the FC6A Series MICROSmart is comparable to formatting it with the quick format option in Windows.

Other Data File Manager Functions

In addition to SD memory card maintenance, the follow operations can be performed with Device Manager. These operations can be used with serial communication over Serial Port 1 or a communication cartridge.

- Display status
- Downloading and uploading user programs
- Update system software

Display status

Click the 1st level (root) in the tree view to display the FC6A Series MICROSmart status.

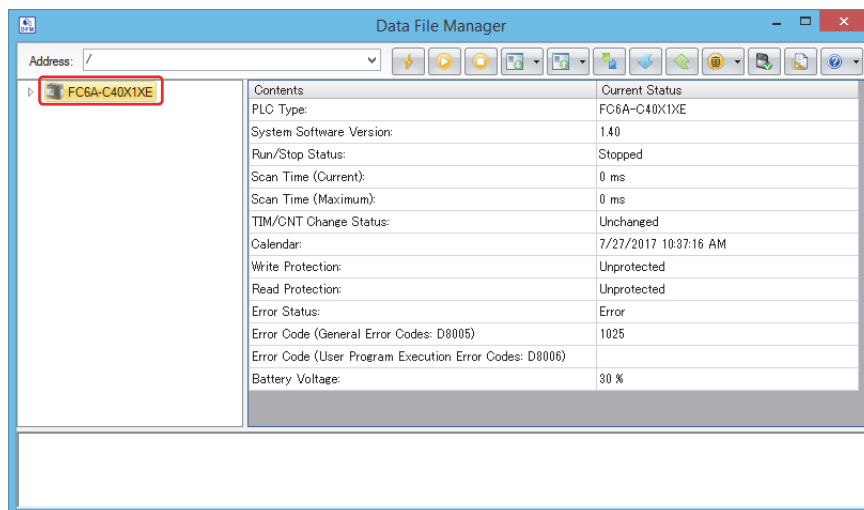

When displaying the status, the address field is displayed as follows.

When connected to the PC over USB

Slash (/)

Example: /

When connected to the PC over Ethernet

IP address: Port number

Example: 192.168.1.100:80/

11: SD MEMORY CARD

Downloading user program

A user program (ZLD file) saved on the PC will be written to the CPU module.

1. Click  on the toolbar.
The **Open** dialog box is displayed.
2. Select the ZLD file to download and click **Open**.
The download starts.

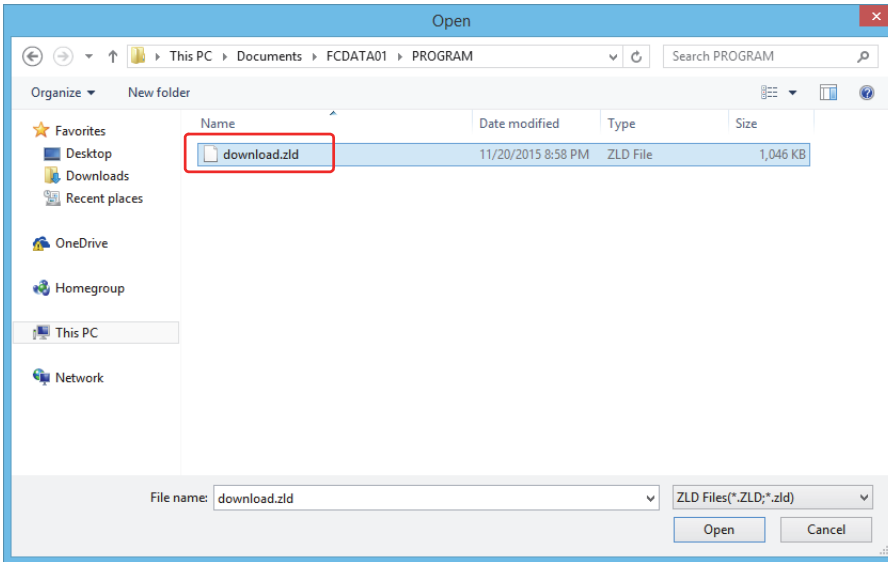

Note: If the user program is protected, the **Password Error** dialog box is displayed. Enter the correct password and click **OK**. For details, see "User Program Protection" on page 5-58.

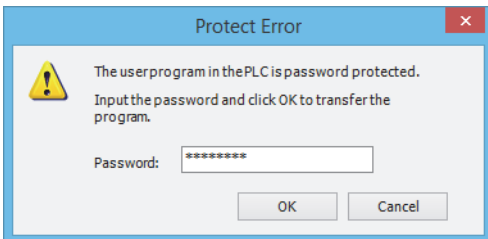

This concludes downloading the user program.

Uploading user program

The user program on the CPU module will be saved to the PC.

1. Click  on the toolbar.
The **Browse For Folder** dialog box is displayed.
2. Enter the destination and the file name and then click **OK**.
The upload starts.

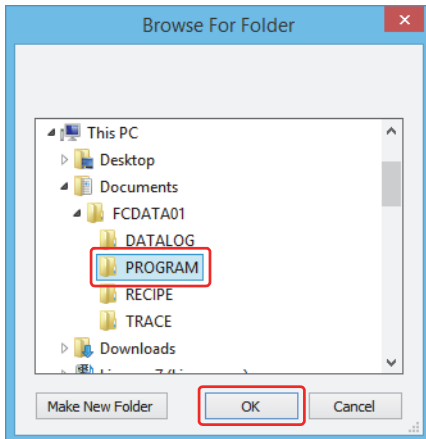

Note: If the user program is protected, the **Password Error** dialog box is displayed. Enter the correct password and click **OK**. For details, see "User Program Protection" on page 5-58.

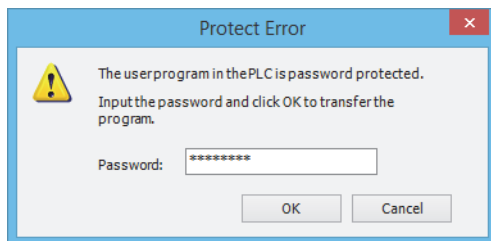

This concludes uploading the user program.

Update system software

The CPU module system software will be updated.

1. Click on the down-pointing triangle button on the right of the  (Download) button and click **Download System Software**.
The **Download system software** dialog box is displayed.
The rest of the operation procedure is the same as downloading system software in WindLDR. For details, see the procedure from step 3 in "Upgrade FC6A Series MICROSmart System Software" on page A-10.

This concludes updating the system software.

11: SD MEMORY CARD

Downloading and Uploading Device Address Data

Device Address Data

Device Address Data Format

The device address data consists of group of values. The number of values is specified with **Number of Data** in **Device Address Data Setting** dialog box.

```
"(Value of device address)",
"(Value of device address number + 1)",
"(Value of device address number + 2)",
.
.
.
"(Value of device address number + (n-1))",
```

} Number of data (*n*)

Creating Device Address Data with Text Editor

The device address data can be created with software tool such as Notepad, text editor from the third party, or spread sheet software.

1. Describe "Device Address Value", comma (,), and line feed as many as the number of data.

Example: When the number of data is 5 and values are 1111, 2222, 3333, 4444, 5555 in this order

```
1111,
2222,
3333,
4444,
5555,
```

2. Save the file with the extension (.csv).

Supported Device Address

The range of device addresses that can be read or written and the maximum number of data are as follows.

Device Name	FC6A-C16/-C24/-C40/-C40XEJ		FC6A-D16/-D32	
	Device Address	Max Number of Data	Device Address	Max Number of Data
Internal relay	M0 to M7997	6,400	M0 to M7997	6,400
	M10000 to M17497	6,000	M10000 to M21247	9,000
Special internal relay	M8000 to M8317	256	M8000 to M9997	1,600
Shift register	R0 to R255	256	R0 to R255	256
Timer preset value	TP0 to TP1023	1,024	TP0 to TP1999	2,000
Counter preset value	CP0 to CP511	512	CP0 to CP511	512
Data register	D0 to D7999	8,000	D0 to D7999	8,000
	D10000 to D55999	46,000	D10000 to D61999	52,000
Special data register	D8000 to D8499	500	D8000 to D8899	900
Non-retentive data register	-	-	D70000 to D269999	200,000

Downloading Device Address Data

The device address data (.csv) that is stored in the computer can be written to the device addresses of the FC6A Series MICROSmart.

Operation Procedure

1. Click on the  (Download Device Address Data (.csv)) on the toolbar. The **Device Address Data Setting** dialog box is displayed.
2. Configure the device address to which data is written and click **Download** button. The **Open** dialog box is displayed.

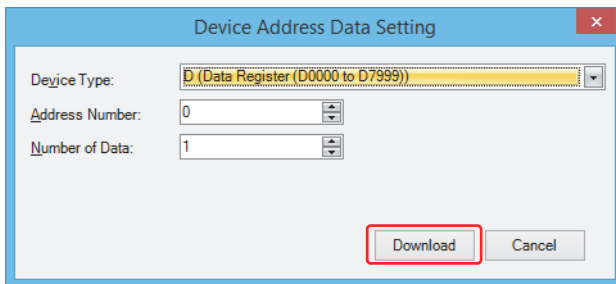

- Device Type
Specify the device type of the device address to which the data is written.
- Address Number
Specify the device address number of the device address to which the data is written.
- Number of Data
Number of data to write to the target device addresses.

Note: For details on available device addresses of FC6A Series MICROSmart, see "Supported Device Address" on page 11-60.

3. Select a device address data (.csv) and click **Open** button. Downloading the device address data starts.

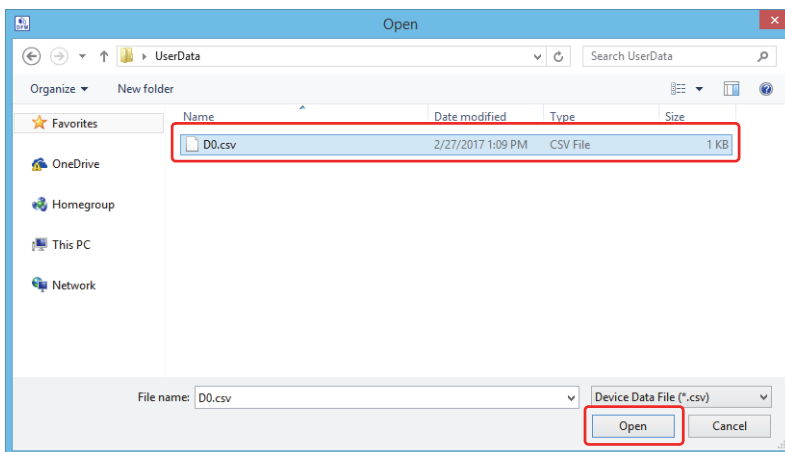

This concludes downloading the device address data.

Notes:

- Do not turn off the FC6A Series MICROSmart while downloading the device address data.
- Cycle the power to the FC6A Series MICROSmart and download ZLD project file again in the following cases:
 - Downloading device address data fails and the communication with FC6A Series MICROSmart becomes not possible.
 - Communication troubles such as cable disconnection or power fail occur and FC6A Series MICROSmart does not respond.

11: SD MEMORY CARD

Uploading Device Address Data

The device address data (.csv) can be read from FC6A Series MICROSmart and saved as a CSV file in the computer.

Operation Procedure

1. Click on the  (Upload Device Address Data (.csv)) on the toolbar.
The **Device Address Data Setting** dialog box is displayed.
2. Configure the device address from which data is read and click **Upload** button.
The **Save As** dialog box is displayed.

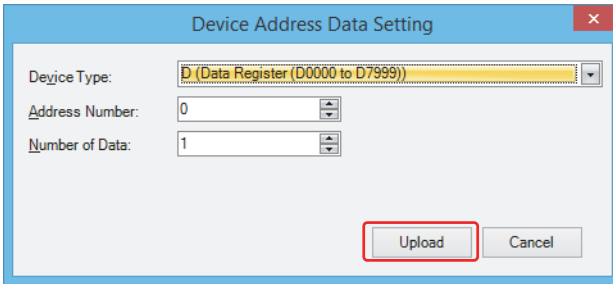

- Device Type
Specify the device type of the device address from which the data is read.
 - Address Number
Specify the device address number of the device address from which the data is read.
 - Number of Data
Number of data to read from the target device addresses.
3. Enter the filename and click **Save** button.
Uploading the device address data starts.

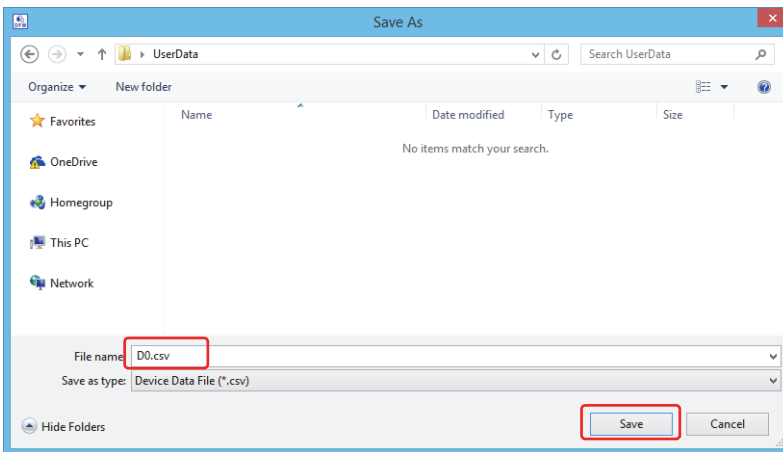

This concludes uploading the device address data.

Clearing Data of FC6A Series MICROSmart

Data stored in the internal memory of FC6A Series MICROSmart can be cleared.

Operation Procedure

1. Click on the down-pointing triangle button on the right of the  (Clear) button and click the menu for the data to clear.
A confirmation message is displayed.
 - Clear values in all device addresses
Device values stored in the internal memory of FC6A Series MICROSmart can be cleared. Types of the devices that are cleared are as follows: inputs, outputs, internal relays, shift registers, data registers, timer current values, and counter current values.
 - Clear Error
Error information stored in the internal memory of FC6A Series MICROSmart can be cleared.
2. Click **Yes** button.

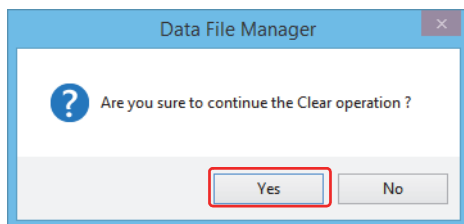

This concludes clearing data.

12: MODULE CONFIGURATION EDITOR

This chapter provides a description of the Module Configuration Editor that can be used to configure expansion modules and cartridges.

Module Configuration Editor Overview

The FC6A Series MICROSmart is capable of using the expansion modules and cartridges described in "Product Specifications" on page 2-1. To use expansion modules and cartridges, they must be configured to connect to the FC6A Series MICROSmart using the WindLDR Module Configuration Editor.

Module Configuration Editor Structure

The Module Configuration Editor is composed of the following three areas.

- Module configuration area : Displays the configuration of connected expansion modules and cartridges.
- Expansion modules and cartridges list : Displays a list of expansion modules and cartridges that can be connected to the FC6A Series MICROSmart.
- Parameter reference area : Displays the parameters that are configured for the expansion modules and cartridges.

The module configuration that will be used is created by selecting the expansion modules and cartridges to use in the expansion modules and cartridges list and dragging and dropping them to the module configuration area.

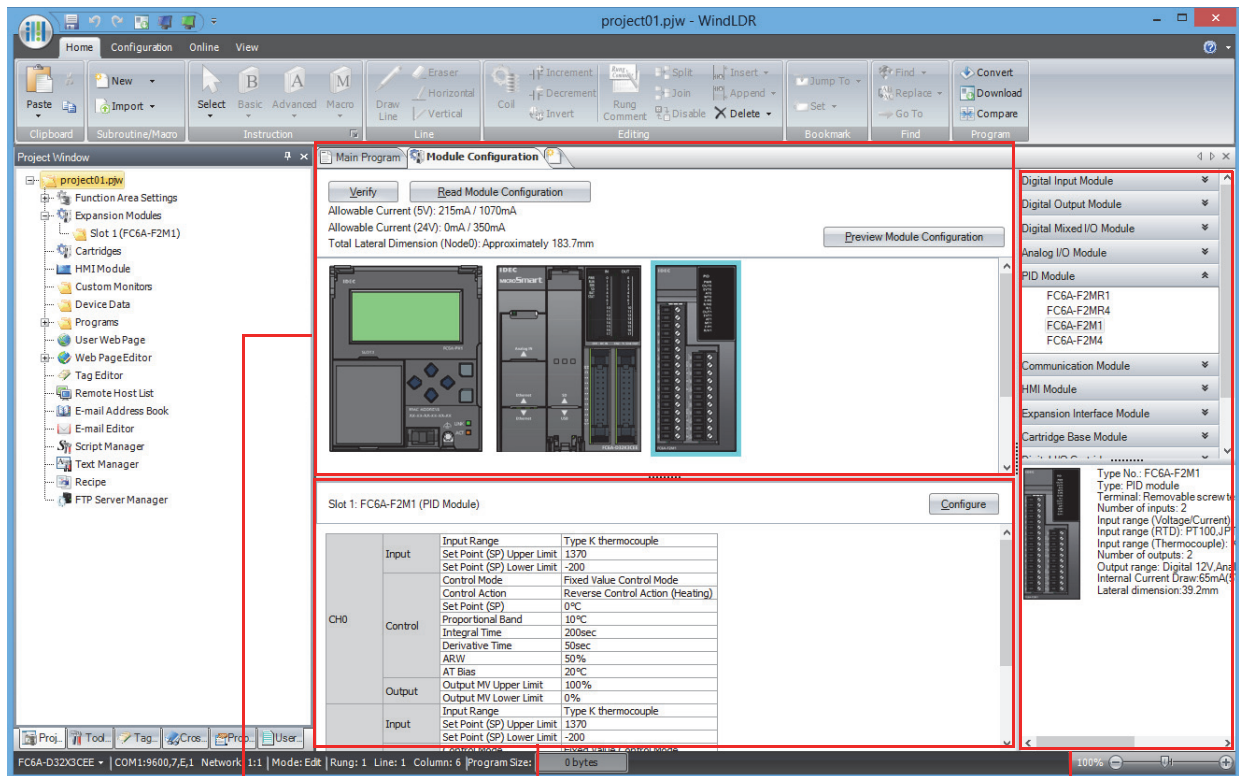

Module Configuration Area

Parameter Reference Area

Expansion Modules and Cartridges List

12: MODULE CONFIGURATION EDITOR

Module Configuration Editor Functions

The Module Configuration Editor functions are as follows. For the operating procedures of the functions, see "Basic Module Configuration Editor Operations" on page 12-3.

Function	Details
Insert expansion modules and cartridges	Expansion modules and cartridges can be inserted into the module configuration area by dragging and dropping them from the expansion modules and cartridges list. By inserting expansion interface remote master and remote slave modules, the nodes can be configured.
Delete expansion modules and cartridges	Inserted expansion modules and cartridges can be deleted. When an expansion module is deleted, all of the modules placed on the right side of the deleted module are shifted to the left.
Swap expansion modules and cartridges	Inserted expansion modules and cartridges can be moved to a different position.
System software version upgrade	The system software on the CPU module, analog I/O module, PID module, expansion interface remote master module, expansion interface remote slave module, HMI module, and Bluetooth communication cartridge can be upgraded.
Read module configuration	Information about the expansion modules and cartridges connected to the CPU module is stored in special data registers. The configuration of expansion modules and cartridges connected to the CPU module is automatically displayed by acquiring this information.

Basic Module Configuration Editor Operations

This section describes the operating procedures for functions in the Module Configuration Editor.

Starting the Module Configuration Editor

This section describes how to start the Module Configuration Editor.

1. On the **Configuration** tab, in the **PLCs** group, select **Expansion Modules**.
The Module Configuration Editor is displayed.

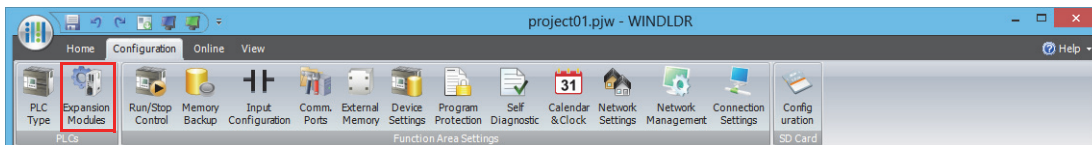

Inserting Expansion Modules and Cartridges

This section describes how to insert expansion modules and cartridges into the module configuration area.

1. Select the expansion module or cartridge to insert in the expansion modules and cartridges list and drag and drop it to the module configuration area.

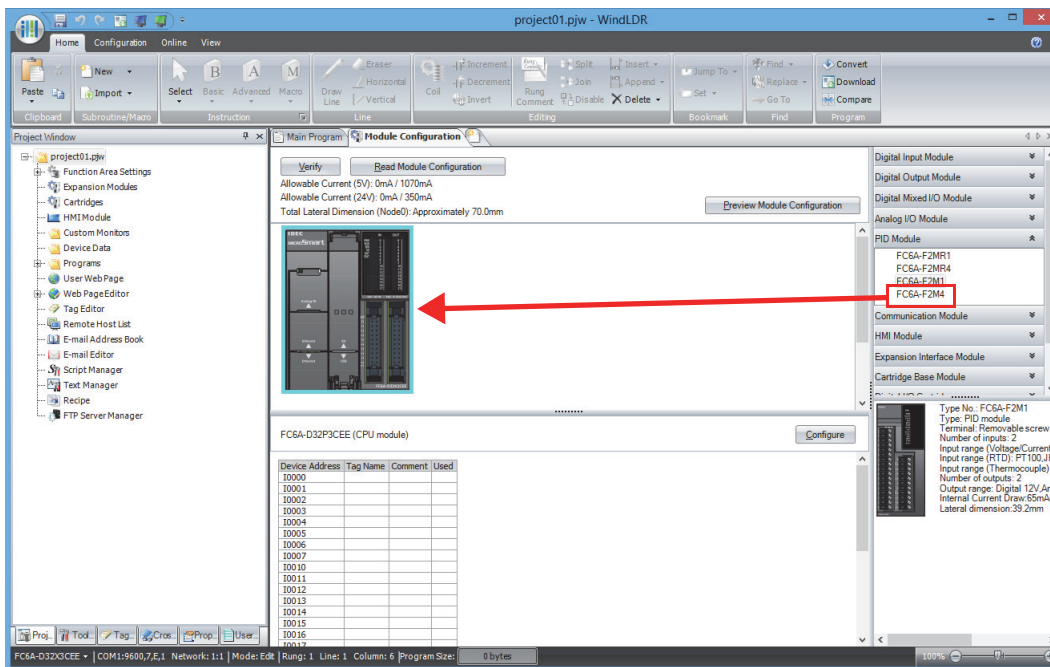

The expansion module or cartridge is inserted into the module configuration area.

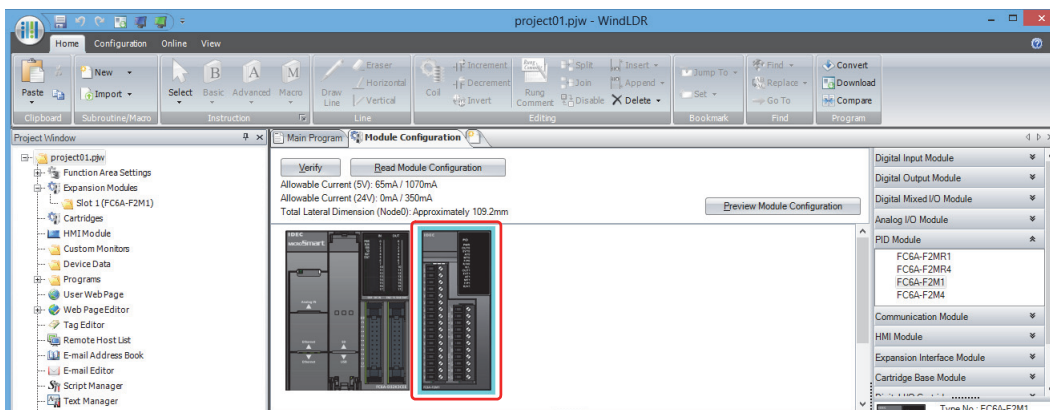

12: MODULE CONFIGURATION EDITOR

- Click the inserted expansion module or cartridge in the module configuration area and click **Configure**. The configuration dialog box that corresponds to the expansion module or cartridge is displayed.

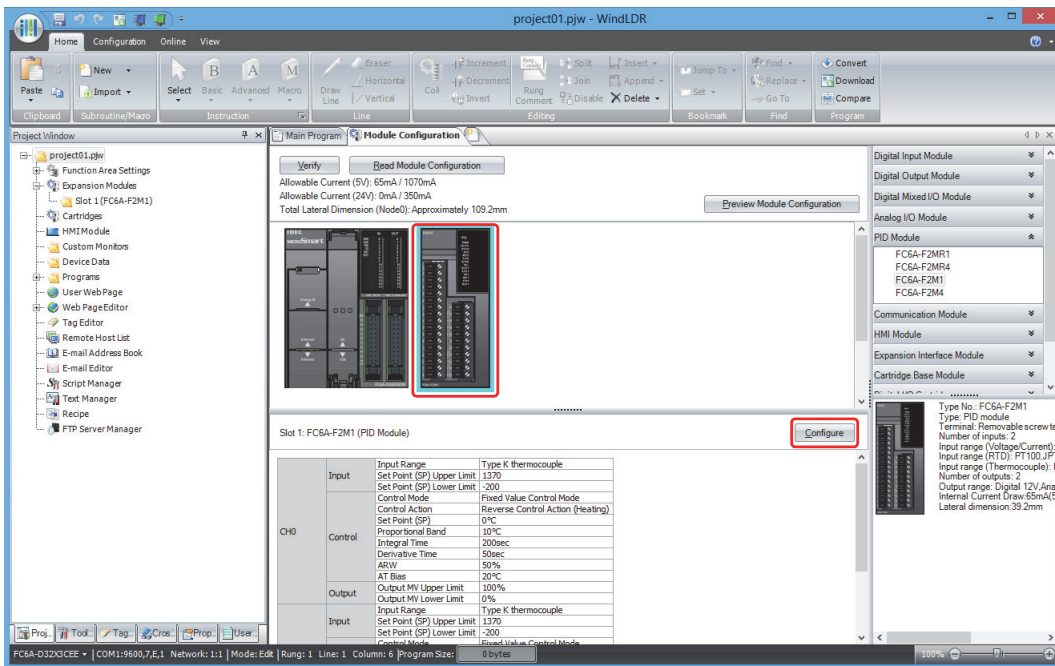

- In the configuration dialog box, configure the parameters for the expansion module or cartridge.

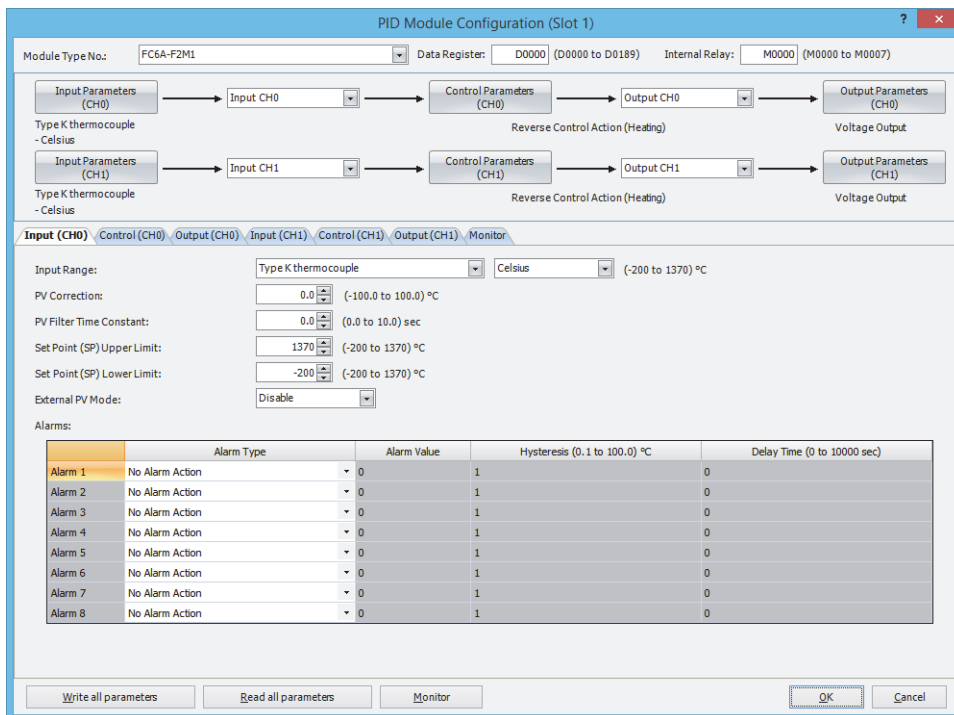

Removing Expansion Modules and Cartridges

This section describes how to remove expansion modules and cartridges that have been inserted into the module configuration area.

1. Click the expansion module or cartridge to remove in the module configuration area.

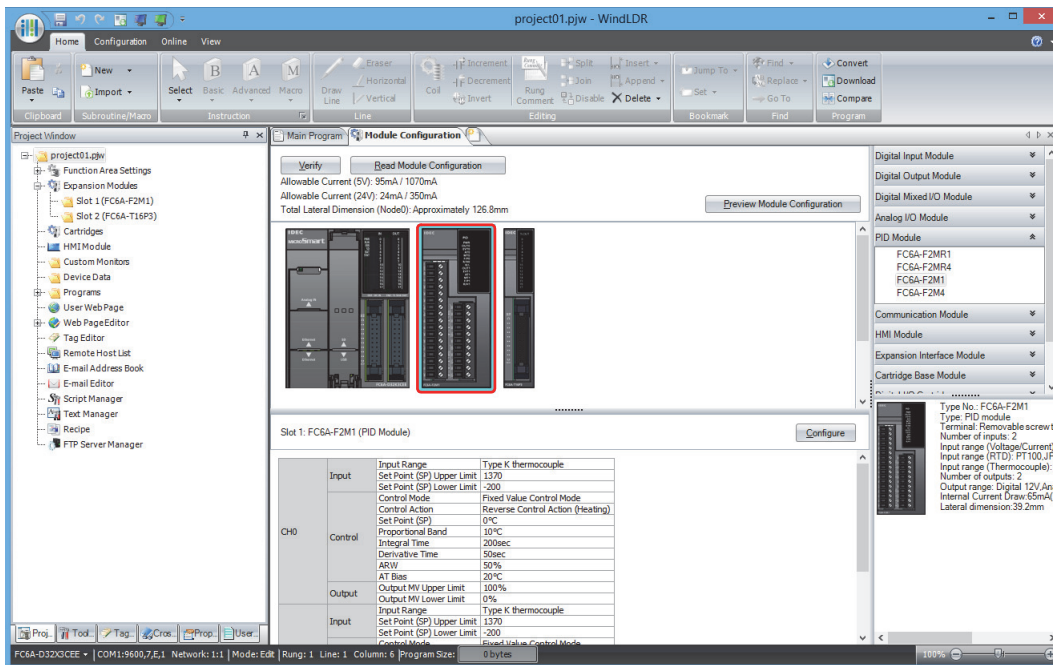

2. Right-click the expansion module or cartridge to delete and click **Remove**.
The selected expansion module or cartridge is removed.
All of the modules placed on the right side of the removed module are automatically shifted to the left.

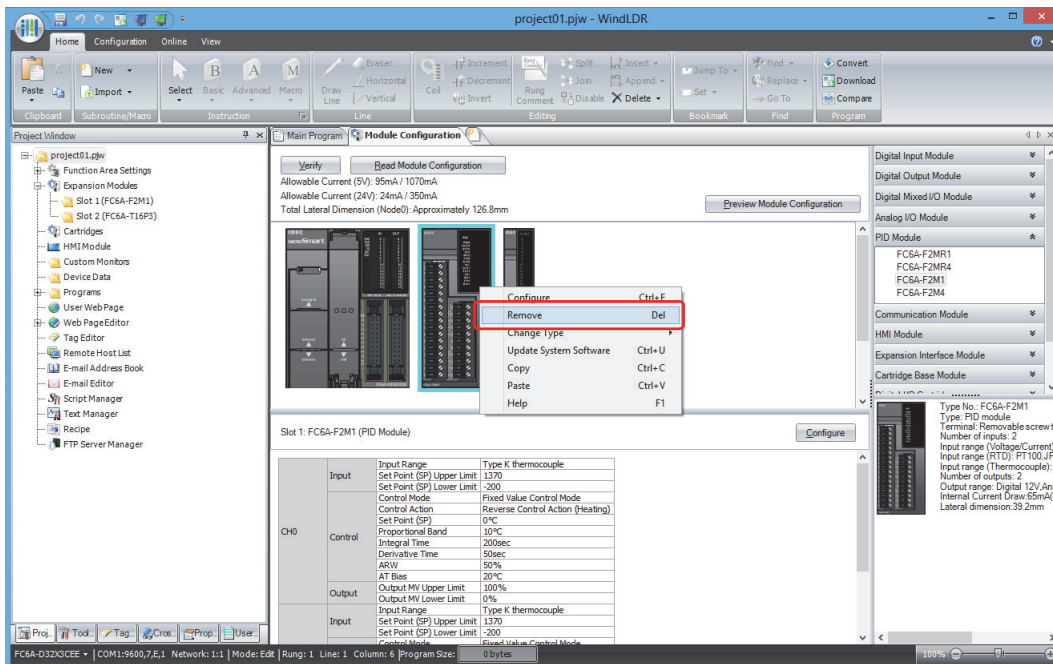

12: MODULE CONFIGURATION EDITOR

Swapping Expansion Modules and Cartridges

This section describes how to change the position of expansion modules and cartridges that have been inserted into the module configuration area.

1. Select the expansion module or cartridge to move and drag and drop it onto the destination expansion module or cartridge.

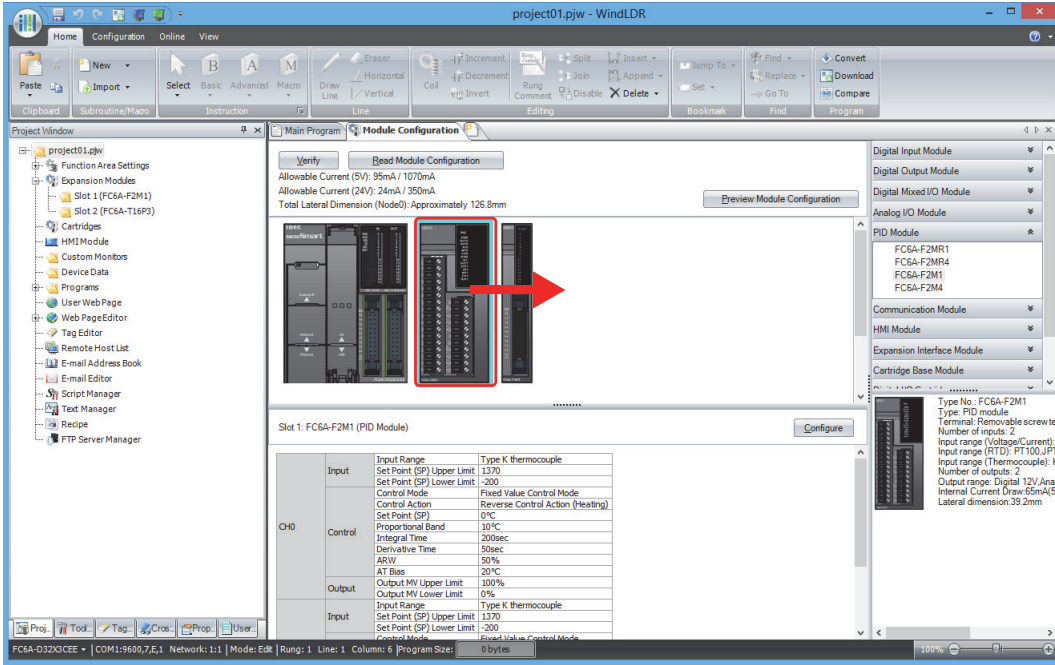

Notes:

- When the position of an I/O module is changed, the device addresses are automatically changed. For example, when the position of digital input module (1) and (2) are changed as shown below, the device addresses I0030 to I0037 for digital input module (1) are changed to I0050 to I0057. However, please note that the device addresses in the program are not replaced.

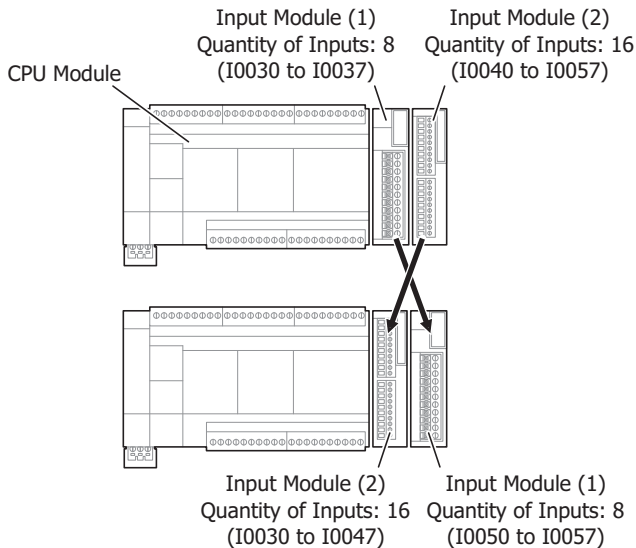

- When the positions of an analog I/O module or analog I/O cartridge are changed, the configured parameters are also moved. However, the device addresses in the program are not replaced.

Upgrading the System Software Version

This section describes how to upgrade the system software on the CPU module, analog I/O module, PID module, expansion interface remote master module, expansion interface remote slave module, HMI module, and Bluetooth communication cartridge.

1. Right-click the CPU module or expansion module that you will perform the system software upgrade on and click **Update System Software**.

The **System Software Download** dialog box is displayed.

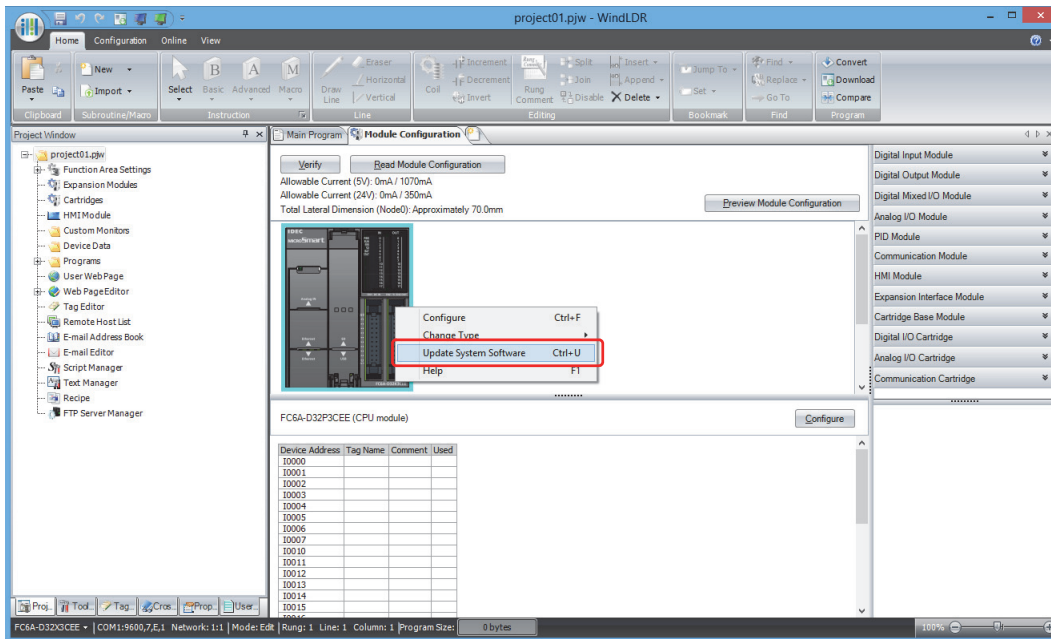

2. Select the system software version number and click **Start System Software Download**.

The system software download begins.

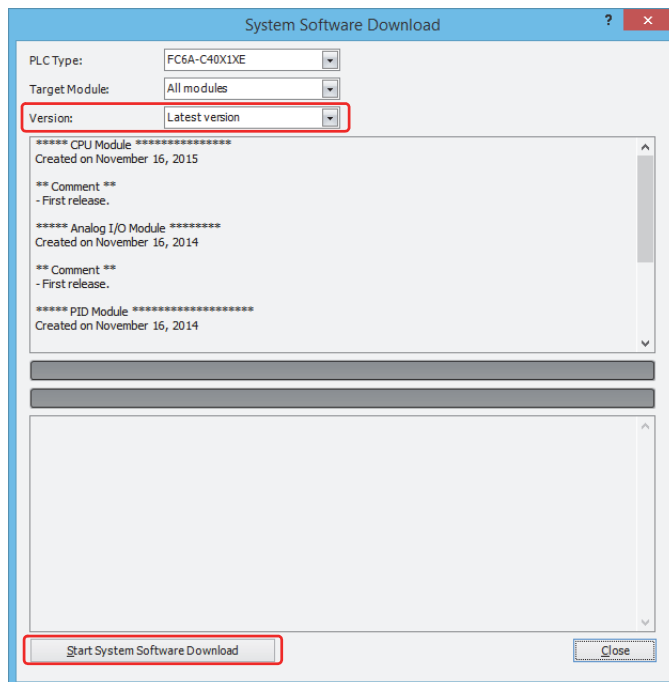

12: MODULE CONFIGURATION EDITOR

Reading the Module Configuration

This section describes how to acquire the information about expansion modules and cartridges connected to the CPU module and automatically display the configuration.

1. Connect a PC to the USB port, Ethernet Port 1, Ethernet Port 2, HMI-Ethernet Port, or Serial Port 1 on the FC6A Series MICROSmart.
For details, see the "FC6A Series MICROSmart Communication Manual".
2. Click **Read Module Configuration** in the module configuration area.

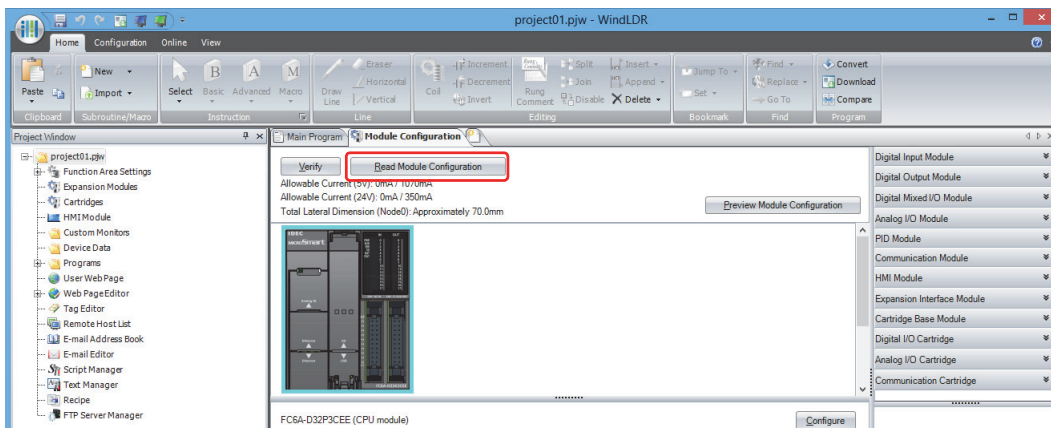

The configuration of expansion modules and cartridges connected to the CPU module is displayed in the module configuration area.

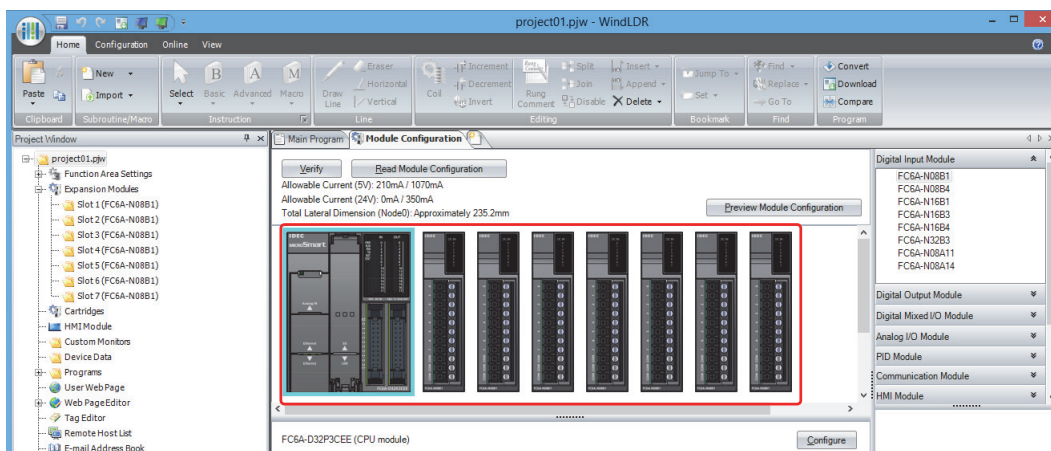

Notes:

- Read module configuration only reads the connection status of expansion modules and cartridges. It does not read the configured parameters. Therefore, the expansion module and cartridge parameters are the default values. Configure the parameters as necessary.
- If digital I/O modules are connected, the actual model number such as FC6A-N08B1 cannot be distinguished by reading the module configuration. The model number will be a general term for number of I/O points such as 16 inputs or 16 outputs. Change the model number to the actual model number after reading the module configuration.
- On the Online tab, in the Monitor group, click Monitor and Start Monitor. The status and current values of expansion modules and cartridges can be checked in the Parameter Reference area.
- If an expansion module or cartridge has an error status, the corresponding module is shown in a red box in the Module Configuration area.

13: TROUBLESHOOTING

Introduction

This chapter describes the procedures to determine the cause of problem and actions to be taken when any problem occurs while operating the FC6A Series MICROSmart.

The FC6A Series MICROSmart has self-diagnostic functions to prevent the spread of problems if any should occur. In case of any problem, follow the troubleshooting procedures to determine the cause and to correct the error.

Errors are checked in various stages. While editing a user program on WindLDR, incorrect devices and other data are rejected. User program syntax errors are found during compilation on WindLDR. When an incorrect program is downloaded to the FC6A Series MICROSmart, user program syntax errors are still checked. Errors are also checked at starting and during operation of the FC6A Series MICROSmart. When an error occurs, the error is reported by turning on the ERR LED on the FC6A Series MICROSmart and an error message can be viewed on WindLDR. For the procedure to check the error status and clear the error by operating the HMI module connected to the CPU module, see "Checking/Clearing Error Information" on page 7-38.

Reading Error Data

When any error occurs during the FC6A Series MICROSmart operation, "Error" is indicated and error details can be read using WindLDR.

Monitoring WindLDR

1. From the WindLDR menu bar, select **Online > Monitor > Monitor**. The monitor mode is enabled.
2. From the WindLDR menu bar, select **Online > Status**. The PLC Status dialog box appears. When any error exists, "Error" is displayed in the error status box.
3. On the right of the Error Status in the PLC Status dialog box, click the **Details** button. The PLC Error Status screen appears.

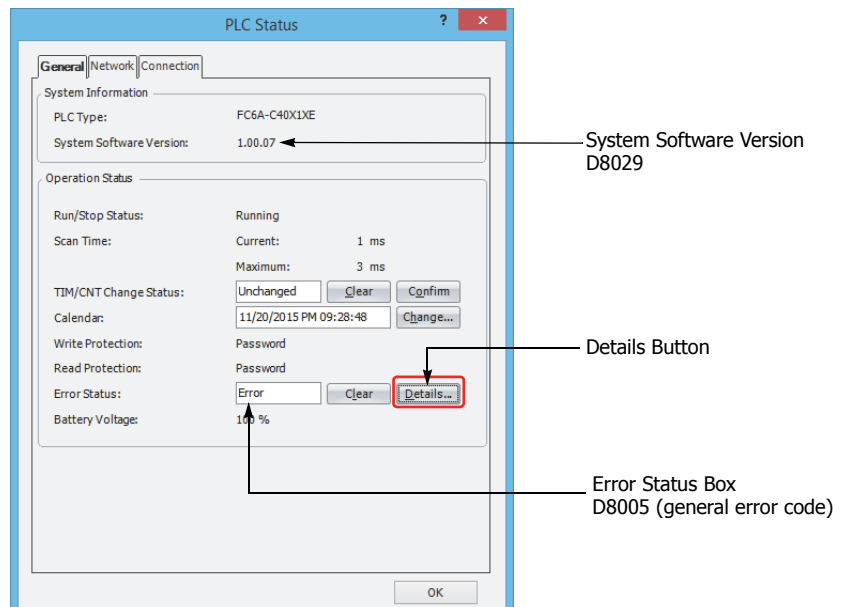

4. Check the errors that are currently occurring.

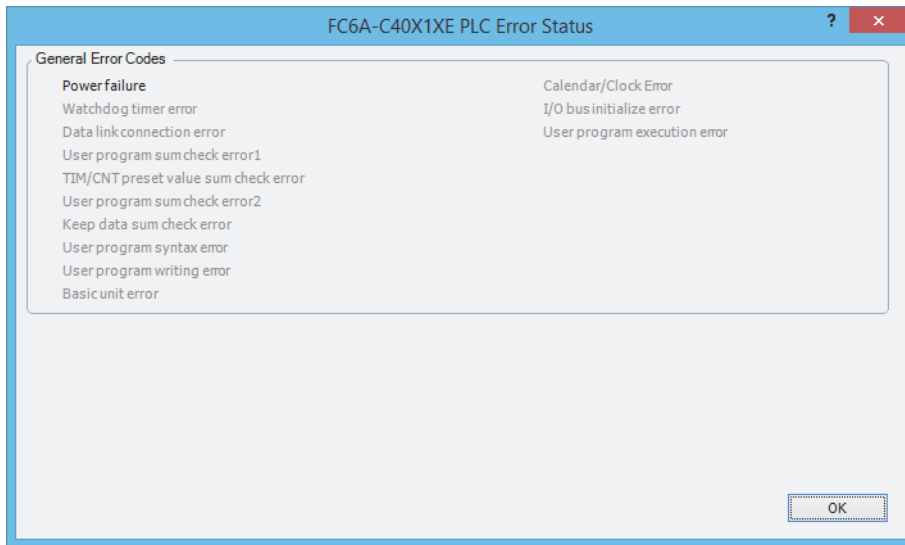

5. After you have checked the errors, click **OK**.

Clearing Error Codes from WindLDR

After removing the cause of the error, clear the error code using the following procedure:

6. From the WindLDR menu bar, select **Online > Monitor > Monitor**. The monitor mode is enabled.
7. From the WindLDR menu bar, select **Online > Status**. The PLC Status dialog box appears.
8. On the right of the **Error Status** in the PLC Status dialog box, click the **Clear** button.

This procedure clears the error code from special data register D8005 (general error code), and the error is cleared from the PLC Status dialog box.

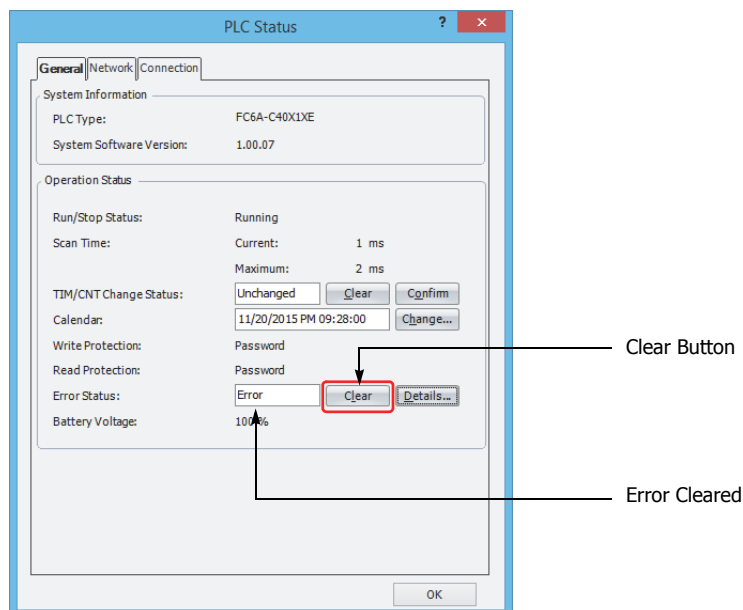

9. Click **OK**.

Special Data Registers for Error Information

Two data registers are assigned to store information on errors.

D8005	General Error Code
D8006	User Program Execution Error Code

Example: This ladder program clears the error information using the error clear bit of special data register D8005.

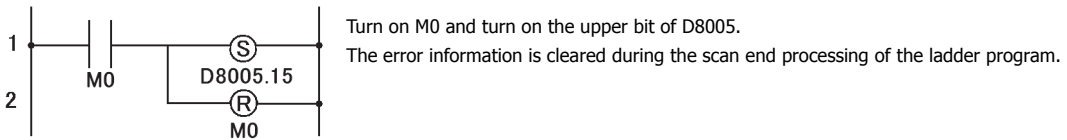

General Error Codes

The general error status is written to special data register D8005. If "1" is stored in each bit of D8005, the corresponding error is occurring.

The general error (D8005) and user program execution error (D8006) can be cleared by writing "1" to the most significant bit of special data register D8005 in a user program. The most significant bit of D8005 then changes to 0 automatically. Errors are not cleared if the most significant bit of D8005 is turned on by WindLDR over communications or by the operator interface.

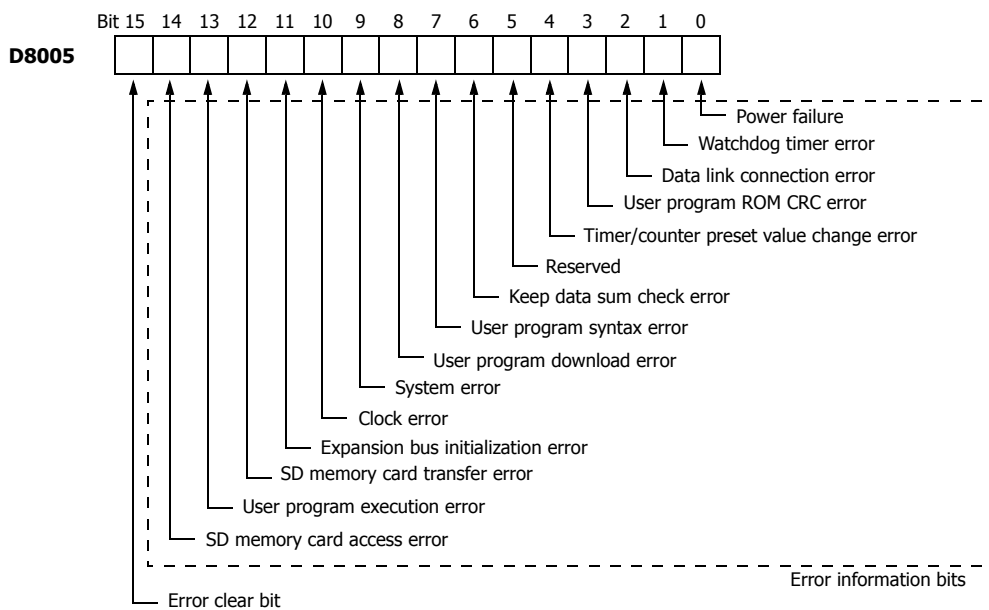

FC6A Series MICROSmart Operating Status, Output, and ERR LED during Errors

Error Items	Operating Status	Output	Error LED [ERR]	Checked at
Power failure	Stop	OFF	—	Any time
Watchdog timer error	Stop	OFF	ON	Any time
Data link connection error	Stop	OFF	ON	When initializing the data link
User program ROM CRC error	Stop	OFF	ON	Starting operation
TIM/CNT preset value change error	Maintained	Maintained	ON	When checking a change in timer/counter settings
Keep data error	Maintained/Stop *1	OFF	—	Turning power on
User program syntax error	Stop	OFF	ON	Downloading user program
User program download error	Stop	OFF	ON	Downloading user program
System error	Stop	OFF	ON	Turning power on
Clock error	Maintained	Maintained	ON	Turning power on
Expansion bus initialization error	Maintained	Maintained	ON	Turning power on/ downloading user program
SD memory card transfer error	Download: Stop Upload: Maintained	Download: OFF Upload: Maintained	ON	When executing an SD memory card download/upload
User program execution error	Maintained	Maintained	ON	Executing user program
SD memory card access error	Maintained	Maintained	ON	When an SD memory card is inserted

*1 Operation starts to run and outputs are turned on or off according to the user program as default, but it is also possible to stop operation and turn off outputs using the Function Area Settings on WindLDR. See "Run/Stop Selection at Keep Data Error" on page 5-9.

Error Causes and Actions

0001h: Power Failure

This error indicates when the power supply is lower than the specified voltage. This error is also recorded when the power is turned off. Clear the error code using WindLDR.

0002h: Watchdog Timer Error

The watchdog timer monitors the time required for one program cycle (scan time). When the time exceeds the allowed time, the watchdog timer indicates an error. Clear the error code using WindLDR. If this error occurs frequently, the FC6A Series MICROSmart has to be replaced.

0004h: Data Link Connection Error

A data link function area settings are incorrect or the cable is not connected correctly. Correct the data link function area settings or connect the cable correctly, and then turn the power off and on or initialize the data link.

0008h: User Program ROM CRC Error

The user program stored in the FC6A Series MICROSmart ROM is corrupted. Download a correct user program to the FC6A Series MICROSmart, and clear the error code using WindLDR.

0010h: Timer/Counter Preset Value Change Error

The execution data of timer/counter preset values is corrupted. The timer/counter preset values are initialized to the values of the user program automatically. Note that changed preset values are cleared and that the original values are restored. Clear the error code using WindLDR.

0040h: Keep Data Sum Check Error

This error indicates that the data designated to be maintained during power failure is corrupted because of memory backup failure. Note that the "keep" data of internal relays and shift registers are cleared. Data of counters and data registers are also cleared. Clear the error code using WindLDR. Replace the backup battery.

For details on replacing the backup battery, see "Replacing the Backup Battery" on page 3-34.

0080h: User Program Syntax Error

This error indicates that the user program has a syntax error. Correct the user program, and download the corrected user program to the FC6A Series MICROSmart. The error code is cleared when a correct user program is transferred.

0100h: User Program Download Error

This error indicates a failure of writing into the FC6A Series MICROSmart ROM when downloading a user program. The error code is cleared when writing into the ROM is completed successfully. If this error occurs frequently, the FC6A Series MICROSmart has to be replaced.

When a memory cartridge is installed on the FC6A Series MICROSmart, writing into the memory cartridge is checked.

0200h: System Error

This error is issued when ROM is not found. When this error occurred, turn power off and on. Clear the error code using WindLDR. If this error occurs frequently, the FC6A Series MICROSmart has to be replaced.

0400h: Clock Error

This error indicates that the clock data has disappeared. Replace the backup battery. For details on replacing the backup battery, see "Replacing the Backup Battery" on page 3-34.

0800h: Expansion Bus Initialization Error

This error occurs when communication could not be performed between the CPU module and the cartridges, expansion modules, and/or HMI module when the power is turned on or during a download.

Cycle the power or update the system software. If this error frequently occurs or it cannot be recovered from, replace the cartridges, expansion modules, and/or HMI module.

1000h: SD Memory Card Transfer Error

This error indicates that the user program cannot be downloaded to/uploaded from FC6A Series MICROSmart using the SD memory card. Check the error details in D8255.

For details, see "D8255: SD Memory Card Download/Upload Execution Error Information" on page 11-46.

2000h: User Program Execution Error

This error indicates that invalid data is found during execution of a user program. When this error occurs, special internal relay M8004 (user program execution error) is turned on.

Referring to the next page to fix and clear the error code.

4000h: SD Memory Card Access Error

This error indicates that the the SD memory card could not be written to.

If the status of M8070 was checked and the SD memory card was not recognized, reinsert a formatted SD memory card into the FC6A Series MICROSmart.

13: TROUBLESHOOTING

User Program Execution Error

This error indicates that invalid data is found during execution of a user program. When this error occurs, the ERR LED and special internal relay M8004 (user program execution error) turned on. The detailed information of this error can be viewed from the error code stored in special data register D8006 (user program execution error code).

User Program Execution Error Code (D8006)	Error Details
1	Source/destination device exceeds range.
2	MUL result exceeds data type range.
3	DIV result exceeds data type range, or division by 0.
4	BCDLS has S1 or S1+1 exceeding 9999.
5	S1 is 10,000 or higher in the HTOB(W) instruction, or S1 is 100,000,000 or higher in the HTOB(D) instruction.
6	BTOH has any digit of S1 exceeding 9.
7	HTOA/ATOH/BTOA/ATOB has quantity of digits to convert out of range.
8	ATOH/ATOB has non-ASCII data for S1 through S1+4.
9	In the WEEK instruction, the ON time data exceeds range (hour data is 24 or higher, minute data is 60 or higher), or the OFF time data exceeds range (hour data is 25 or higher, minute data is 60 or higher, hour data is 24 but minute data is not zero). WKTIM has S1, S2, and S3 exceeding the valid range. S1: 0 through 127 S2/S3: Hour data 0 through 23, minute data 0 through 59 S2/S3 can be 10000. WKTBL instruction is not programmed or WKTIM instruction is executed before WKTBL instruction when 1 (additional days in the week table) or 2 (skip days in the week table) is set for MODE in the WKTIM instruction.
10	In the YEAR instruction, the month and day data exceeds range (month data is 13 or higher, day data is 32 or higher). In the WKTBL instruction, S1 to Sn is out of the range (month data is not between 1 and 12, day data is not between 1 and 31).
11	In the DGRD instruction, BCD and 5 digits are specified but the data exceeds 65,535.
12	CVXTY/CVYTX is executed without matching XYFS. XYFS and CVXTY/CVYTX have the same S1, but have different data types.
13	CVXTY/CVYTX has S2 exceeding the value specified in XYFS.
14	Label in LJMP, LCAL, or DJNZ is not found.
16	Executed invalid PID/PIDA instruction.
18	Attempt was made to execute an instruction that cannot be used in an interrupt program (see "Instructions Reference" on page 8-1).
19	Attempt was made to execute an instruction that is not available for the PLC.
20	Pulse output instructions have invalid values in operation parameters.
21	DECO has S1 exceeding 255.
22	BCNT has S2 exceeding 256.
23	ICMP>= has S1 < S3.
25	BCDLS has S2 exceeding 7.
26	DI or EI is executed when interrupt input or timer interrupt is not programmed in the Function Area Settings.
27	Work area is broken when using DTML, DTIM, DTMH, DTMS, or TTIM.
28	Source device data for F (float) data type instruction exceeds the valid range.
29	Result of F (float) data type instruction exceeds the data type range.
30	The shift data size or the number of bits to shift configured in the SFTL/SFTR instruction exceeds the valid range.
31	In the FIFOF instruction, the FIEX instruction or the FOEX instruction was executed before the FIFO data file was registered.
32	TADD, TSUB, HOUR, or HTOS has invalid data for source device S1.
33	RNDM has invalid data. S1 data is greater than S2 data or S1 or S2 data exceeds 32,767.
35	In the SUM instruction, the execution result exceeds the valid range for the selected data type, or S2 data is 0.

User Program Execution Error Code (D8006)	Error Details
36	DLOG/TRACE is executed but the capacity of CSV file exceeds the maximum size of a day or the number of files exceeds the maximum number of a day.
41	SD memory card is write protected.
42	The result of execution using the SCRPT instruction is a value that indicates anything other than normal completion.
46	In the SCALE instruction, the input minimum value is larger than the input maximum value, the output minimum value is larger than the output maximum value, or the dead band data exceeds the valid range.
48	Pulse output instructions using the same pulse output are executed at the same time.
49	Pulse output instructions referring to the absolute position counter are executed without initializing the absolute position counter with ABS instruction.

User Program Execution Error History

Use this function to check the history of user program execution errors. This function is supported with the Plus CPU module only.

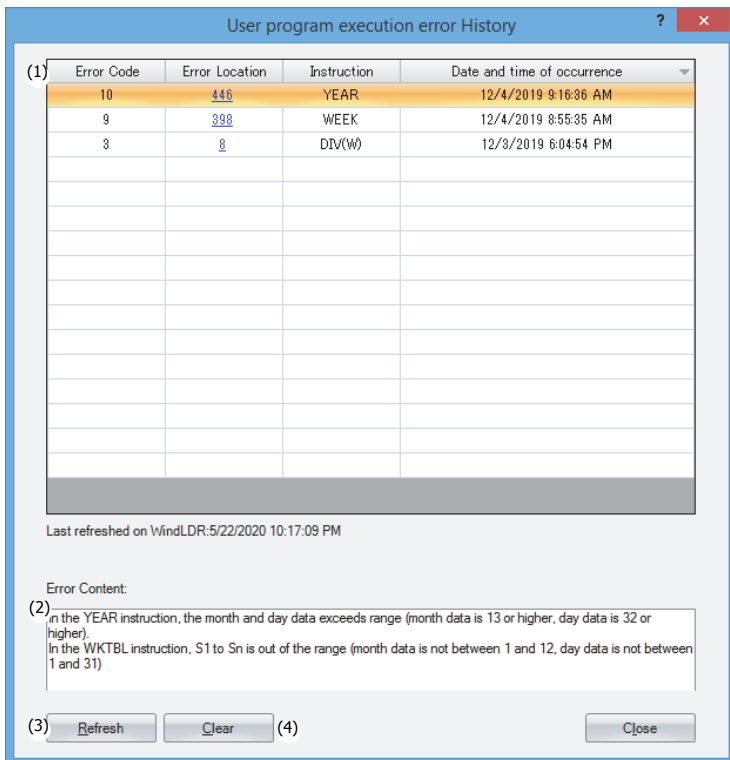

Function Description

(1) Error history

- Error Code: The error code of the user program execution error that occurred. For details on error codes, see "User Program Execution Error" on page 13-6.
- Error Location: The location where the user program execution error occurred. This is the line number displayed in the WindLDR Ladder Editor.
- Instruction: The instruction in which the user program execution error occurred. This is the instruction symbol displayed in the WindLDR Ladder Editor.
- Date and time occurrence: The date and time that the user program execution error occurred. This date and time is that of the clock in the CPU module. The date and time format is YYYY/MM/DD HH:MM:SS. The error history is displayed sorted in ascending order of the date and time of occurrence. Click the header for the date and time of occurrence column to change the order.

(2) Error Content

This area displays the details of the error that is selected in the error history.

(3) Refresh button

This button gets the user program execution error history from the FC6A Series MICROSmart and updates the display.

(4) Clear button

This button erases the user program execution error history held on the FC6A Series MICROSmart.

Note: The user program execution error history contains a maximum of 16 entries. If the number of entries in the user program execution error history exceeds 16 entries, the entries are erased from those with the oldest date and time of occurrence.

Checking the User Program Execution Error History in WindLDR

1. In the **Online** tab, click **User program execution error History** under **Maintenance**.

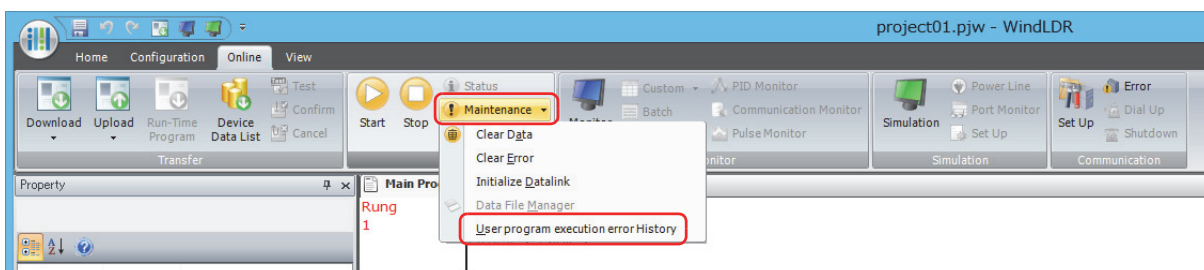

2. The **User program execution error History** dialog box is displayed.

The dialog box titled 'User program execution error History' displays the following table:

Error Code	Error Location	Instruction	Date and time of occurrence
10	416	YEAR	2019/07/25 14:06:39

Last refreshed on WindLDR: 2019/10/7 8:39:50

Error Content

Error Code 10: In the YEAR instruction, the month and day data exceeds range (month data is 13 or higher, day data is 32 or higher).
In the WKTBL instruction, S1 to Sn is out of the range (month data is not between 1 and 12, day data is

Buttons: Refresh, Clear, Close

Note: If the ladder program on the FC6A Series MICROSmart is not the same as the ladder program displayed in the WindLDR Ladder Editor, search for the instruction symbol near the line number of the location where the error occurred.

Troubleshooting Diagrams

When one of the following problems is encountered, see the following trouble shooting diagrams:

Problem	Troubleshooting Diagram
The power is not on.	Diagram 1
Operation has not started.	Diagram 2
An error has occurred.	Diagram 3
Input does not operate normally.	Diagram 4
Output does not operate normally.	Diagram 5
Cannot stop or reset operation.	Diagram 6
Watchdog timer error occurs and the CPU does not run.	Diagram 7
The interrupt/catch input cannot receive short pulses.	Diagram 8
Frequency measurement does not work.	Diagram 9
Data is not transmitted at all in the user communication mode.	Diagram 10
Data is not transmitted correctly in the user communication mode.	Diagram 11
Data is not received at all in the user communication mode.	Diagram 12
Data is not received correctly in the user communication mode.	Diagram 13
Modbus master communication does not work.	Diagram 14
Long communication cycle for Modbus RTU master communication or Modbus TCP client communication.	Diagram 15
WindLDR and the FC6A Series MICROSmart cannot communicate.	Diagram 16
WindLDR does not communicate with PLC via USB.	Diagram 17
Modbus master communication request is slow.	Diagram 18

Troubleshooting Diagram 1**• The Power LED [PWR] is not On**

When the USB bus is operating, the power LED [PWR] does not turn on.

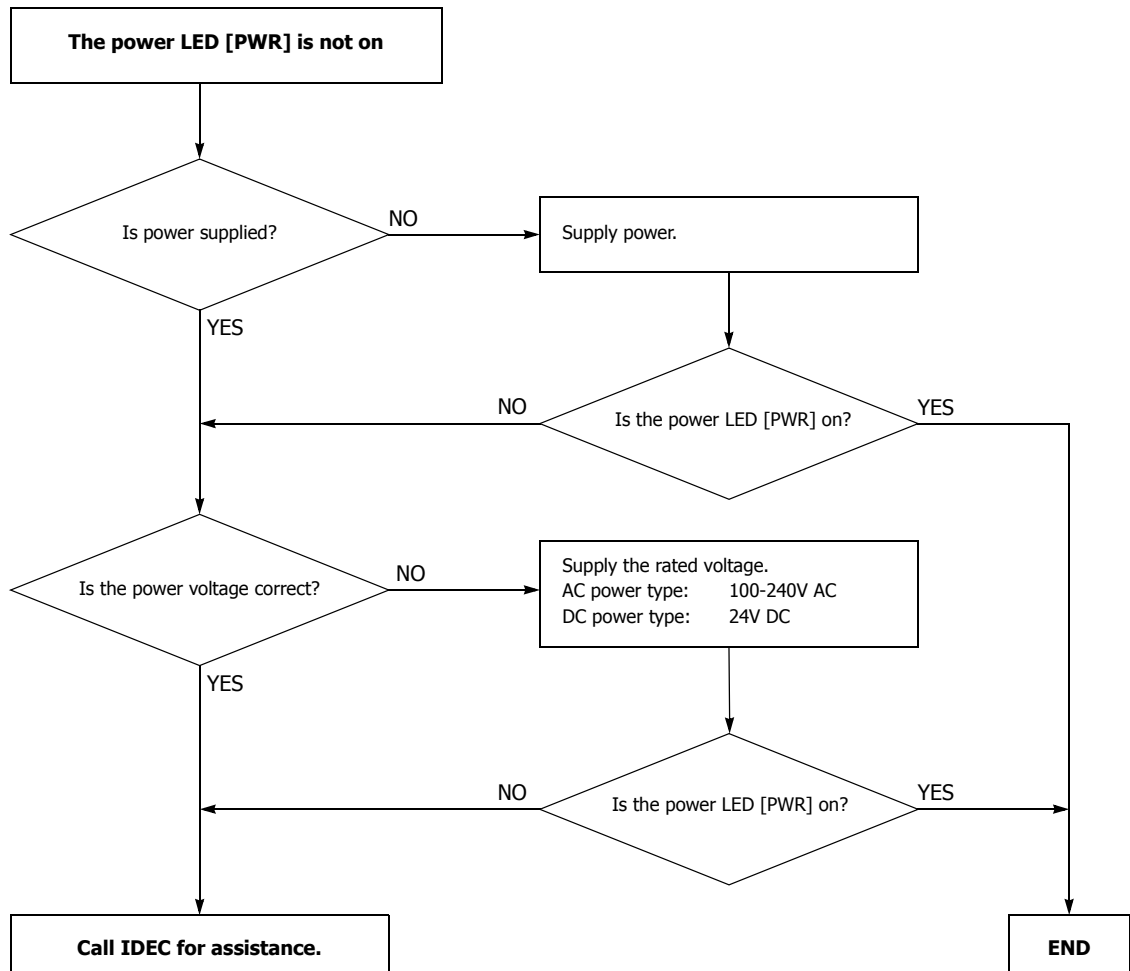

Troubleshooting Diagram 2

• The Run LED [RUN] is not On

The run LED [RUN] turns on when the PLC is running.

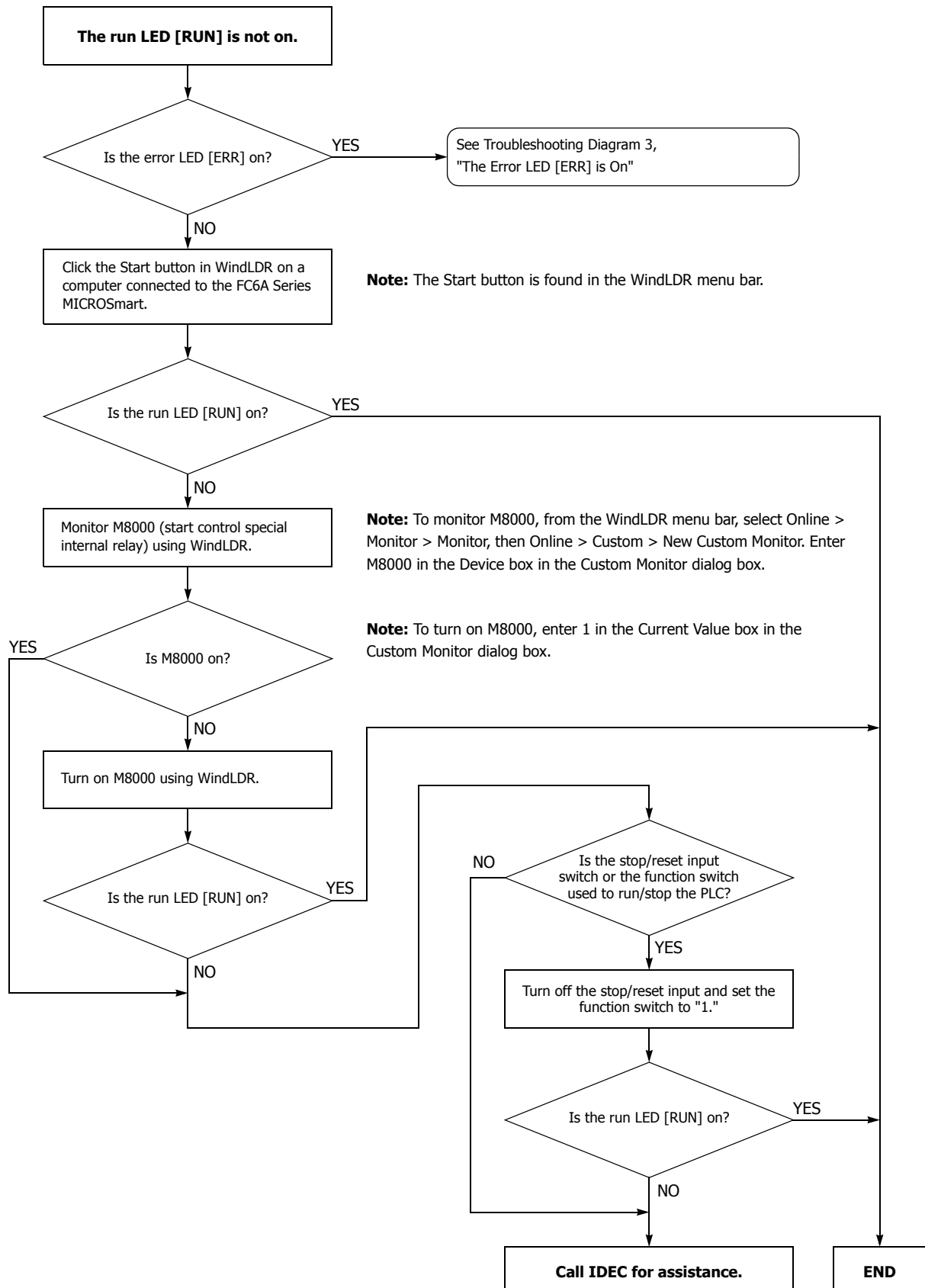

Troubleshooting Diagram 3

- The Error LED [ERR] is On

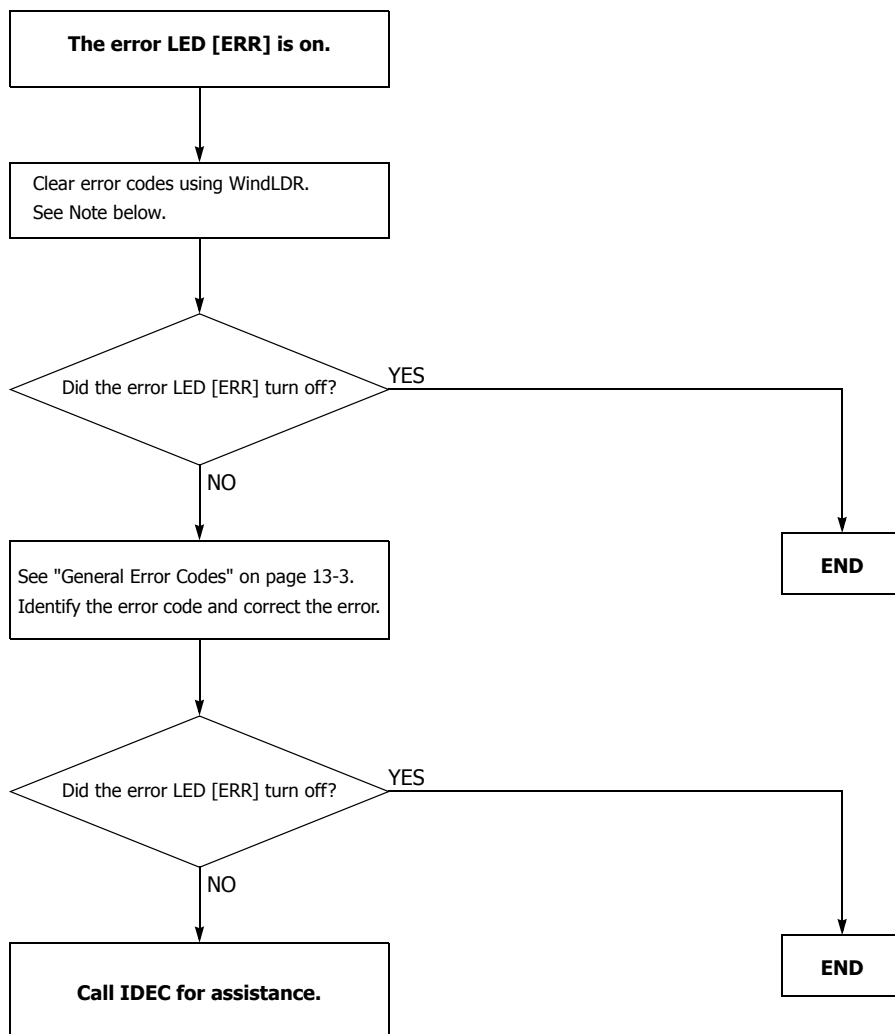

Note: Temporary errors can be cleared to restore normal operation by clearing error codes from WindLDR. See "Clearing Error Codes from WindLDR" on page 13-2.

Troubleshooting Diagram 4

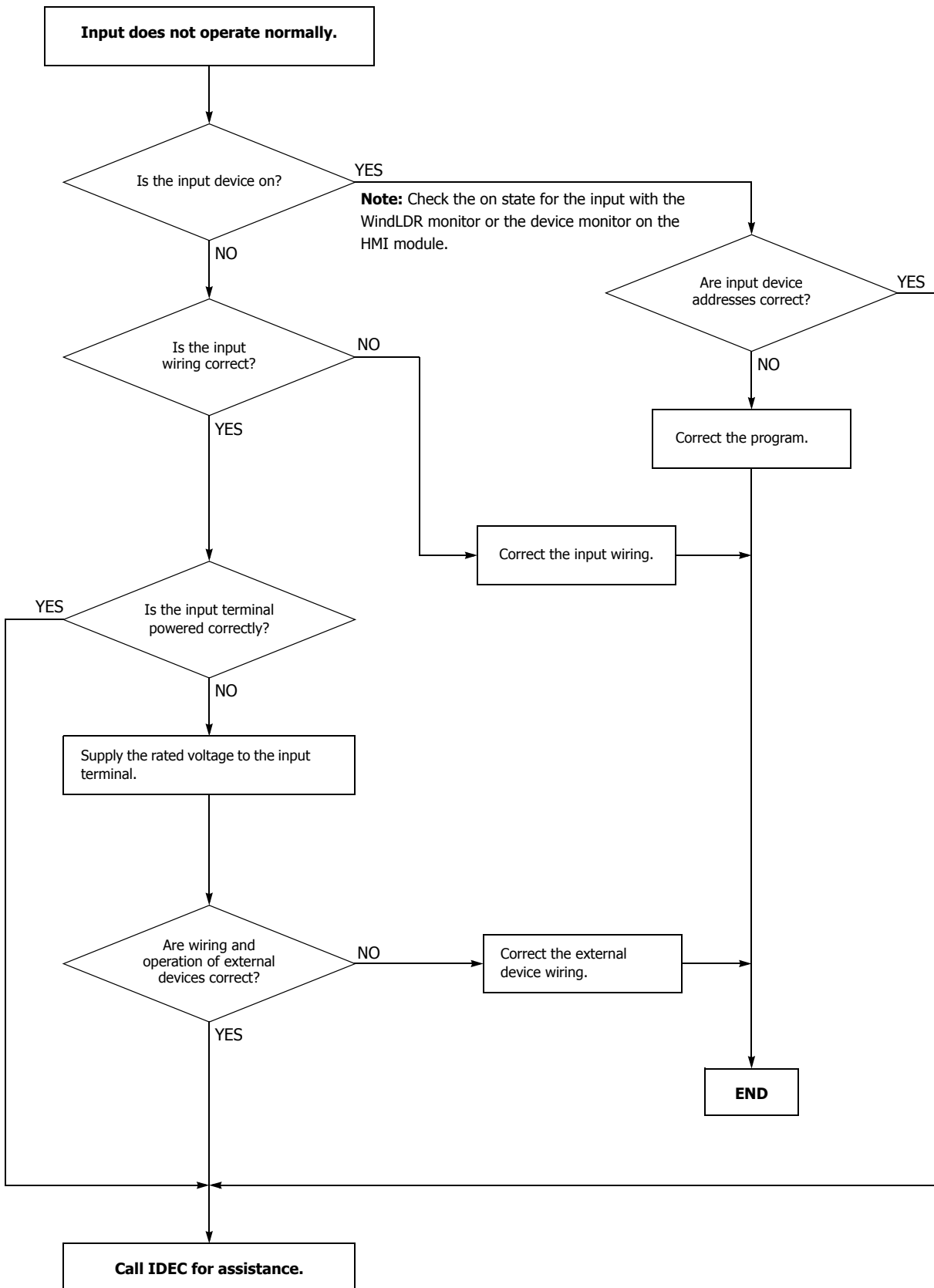

Troubleshooting Diagram 5

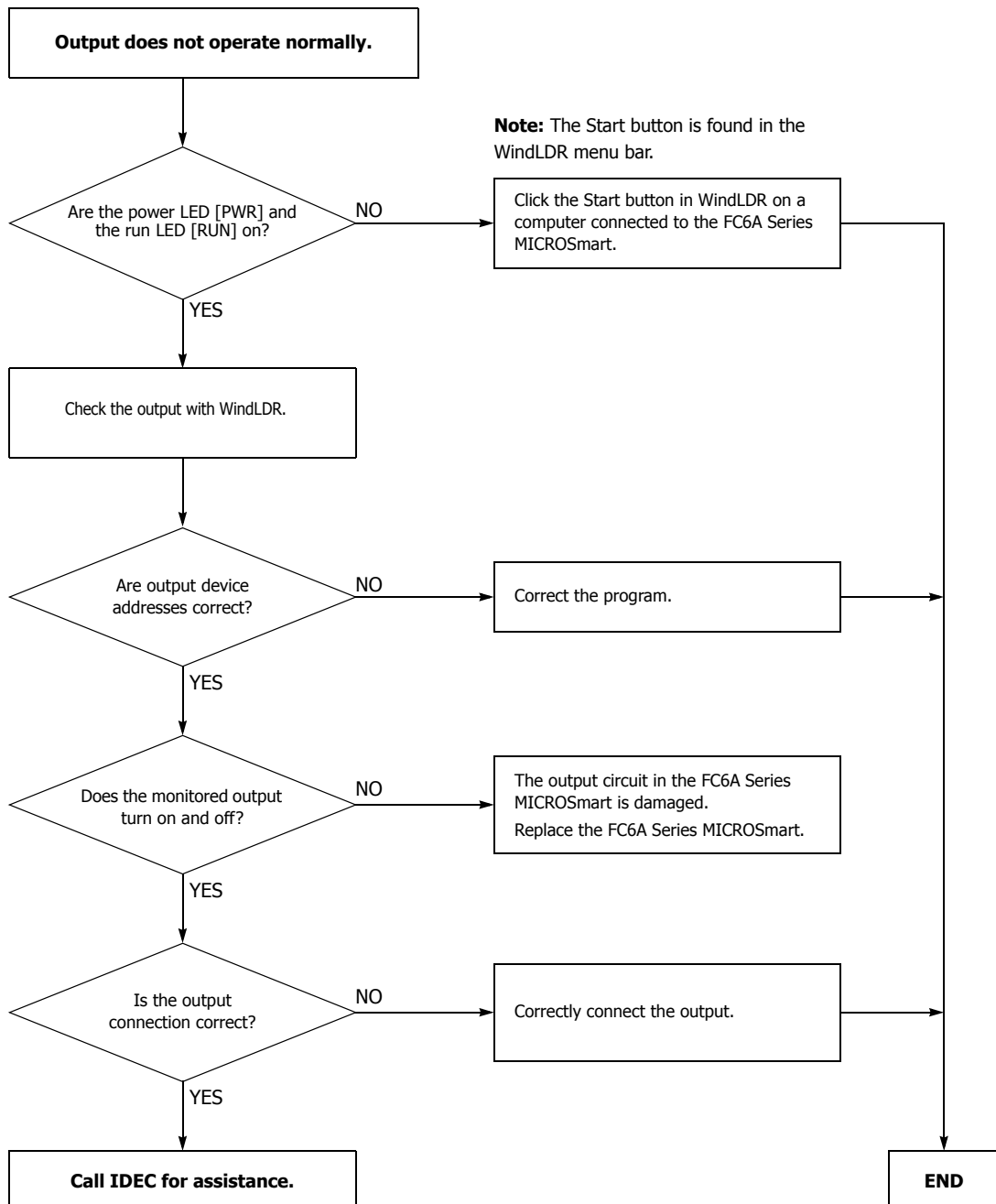

Troubleshooting Diagram 6

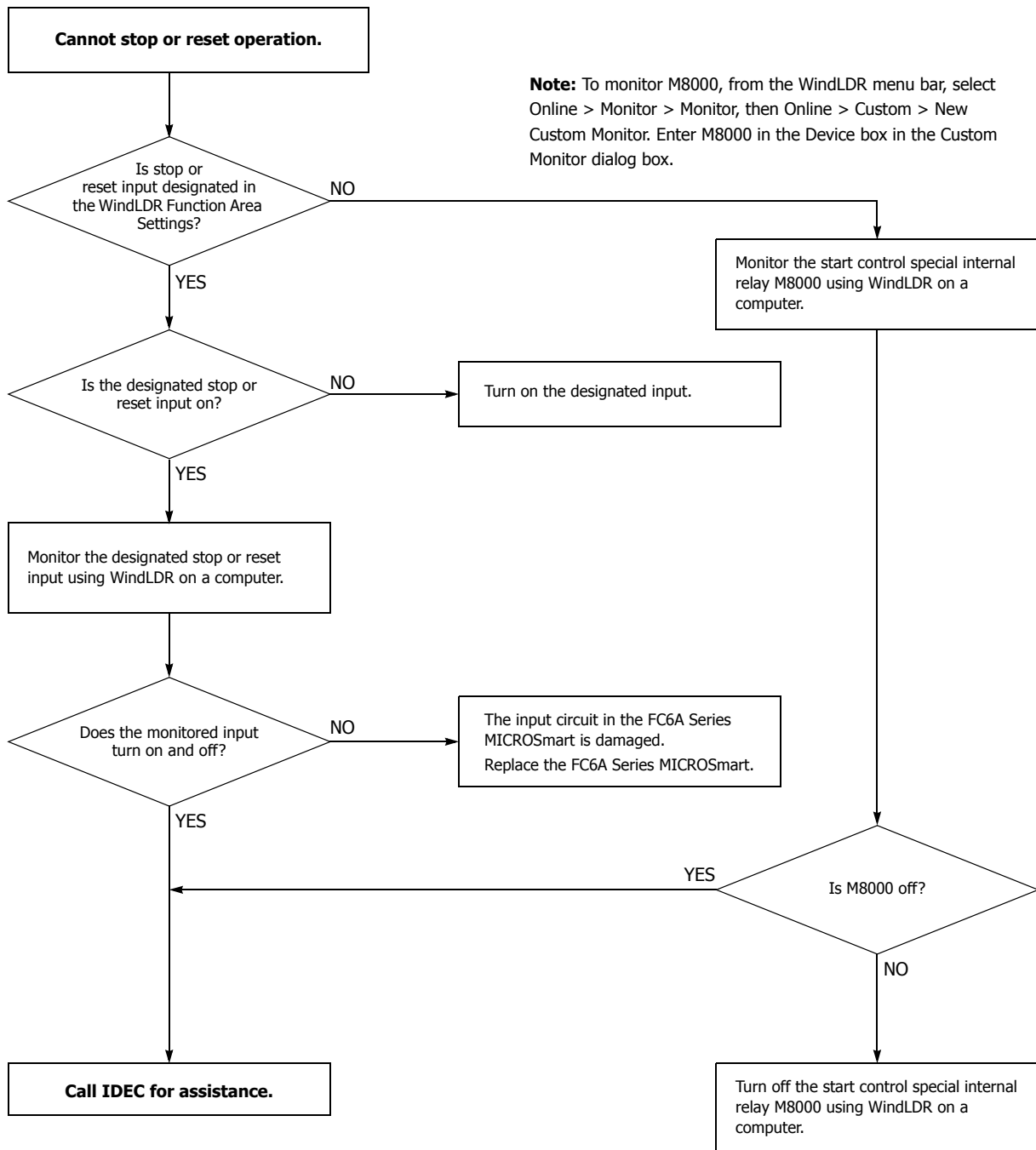

Note: To turn off M8000, enter 0 in the Current Value box in the Custom Monitor dialog box. For details on special internal relay M8000, see "M8000: Start Control" on page 6-9.

Troubleshooting Diagram 7

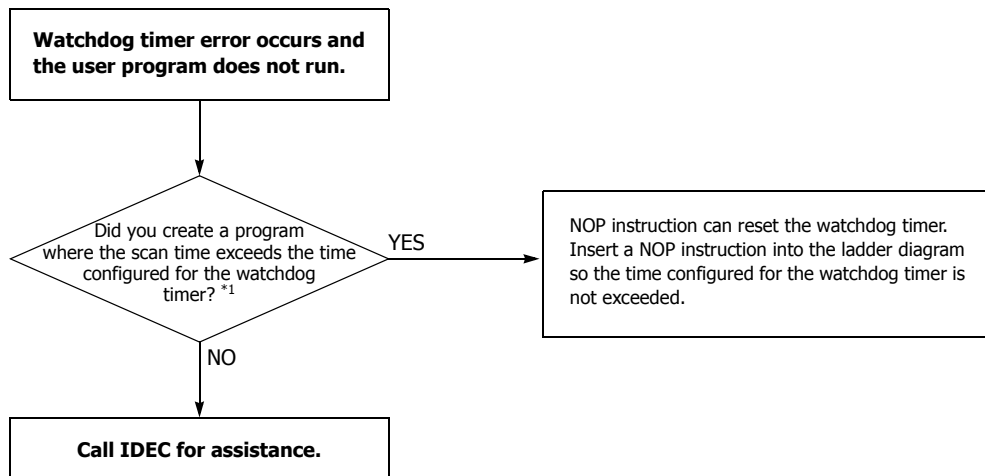

*1 See "Watchdog Timer Setting" on page 5-60.

Troubleshooting Diagram 8

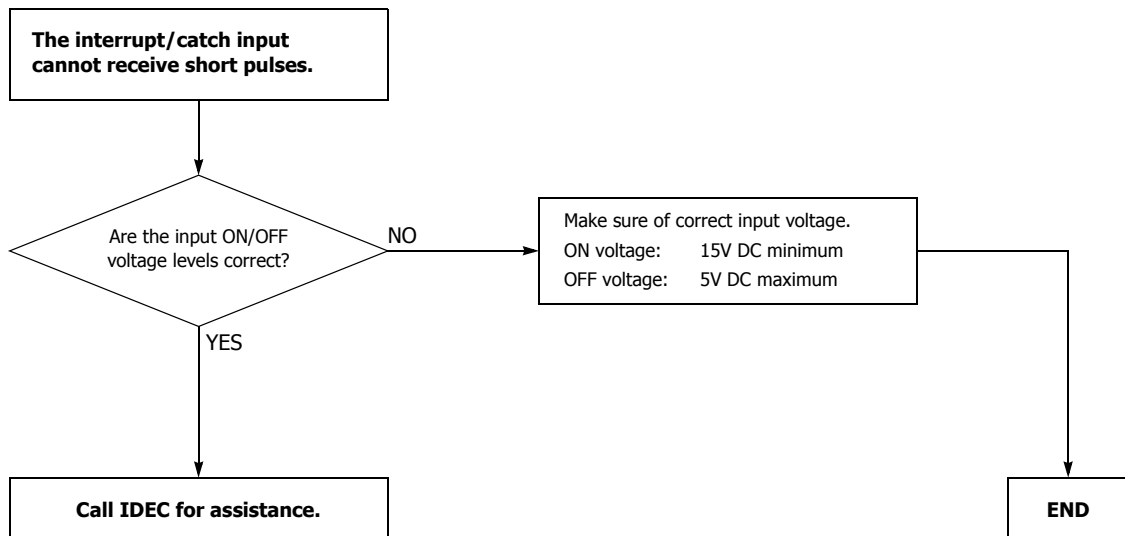

Troubleshooting Diagram 9

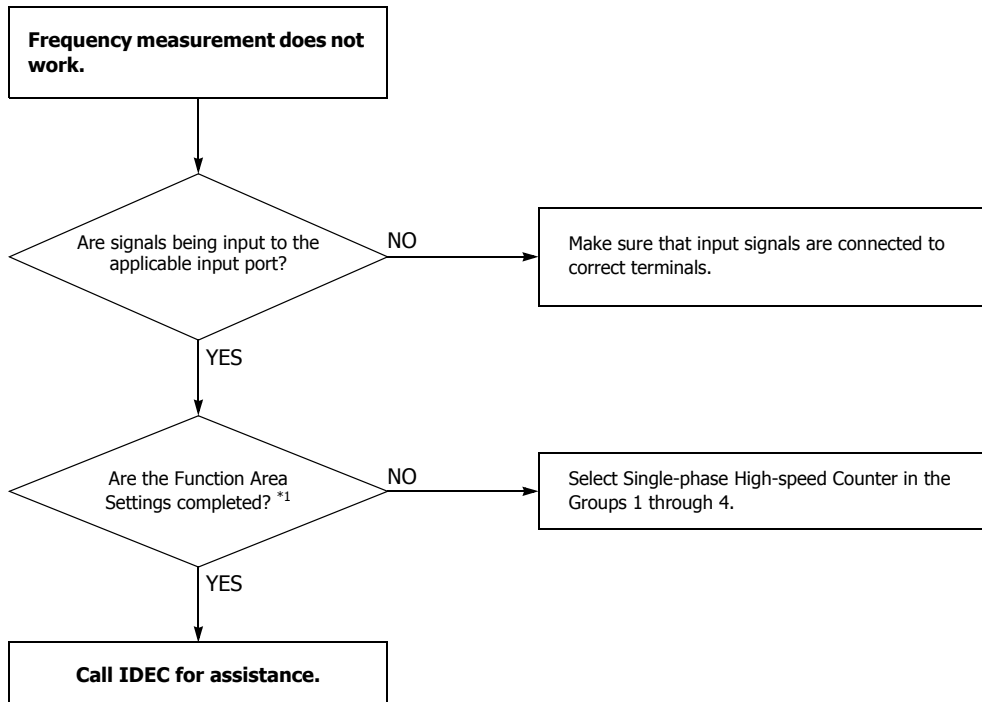

*1 See "Frequency Measurement" on page 5-40.

Troubleshooting Diagram 10

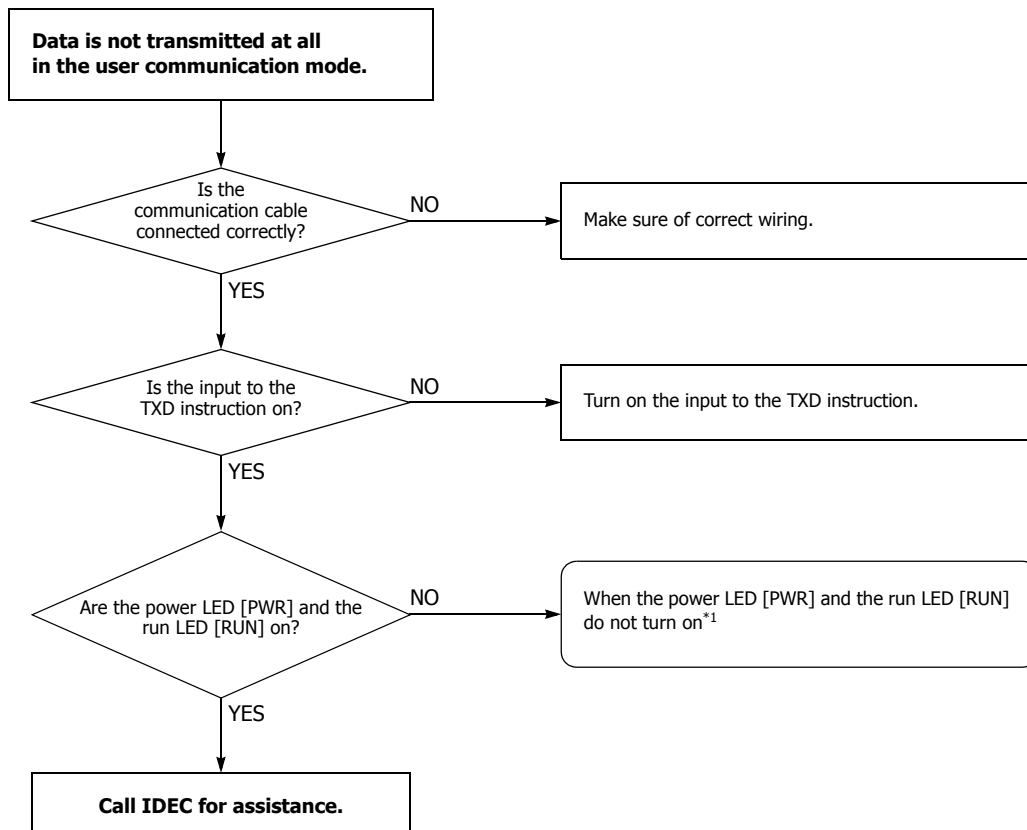

*1 See "The Power LED [PWR] is not On" on page 13-11 or "The Run LED [RUN] is not On" on page 13-12.

Troubleshooting Diagram 11

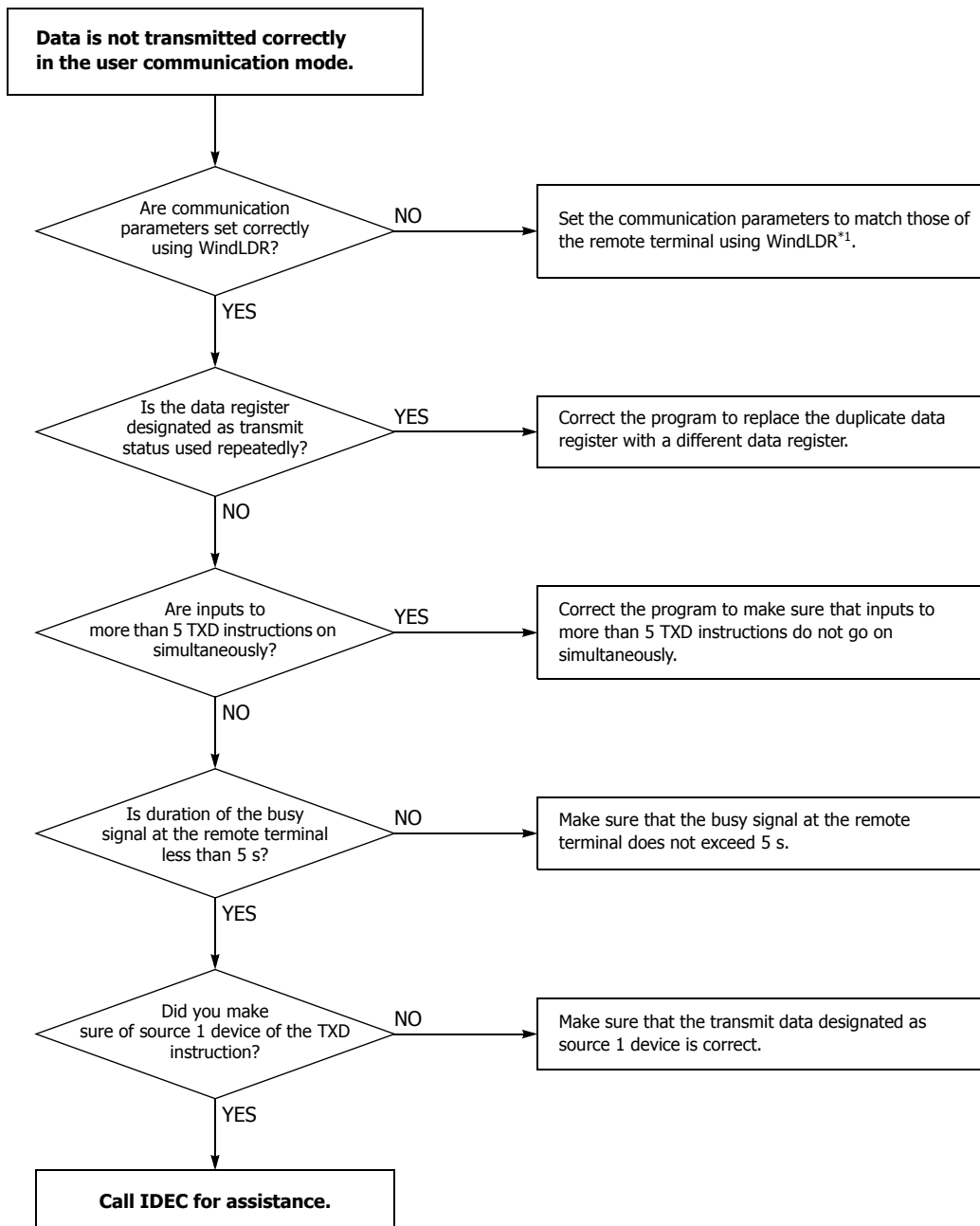

*1 See Chapter 5 "User Communication via Serial Communication" - "Programming WindLDR" in the "FC6A Series MICROSmart Communication Manual".

If the user communication still has a problem after completing the above procedure, also perform the procedure of Diagram 10, described on the preceding page.

Troubleshooting Diagram 12

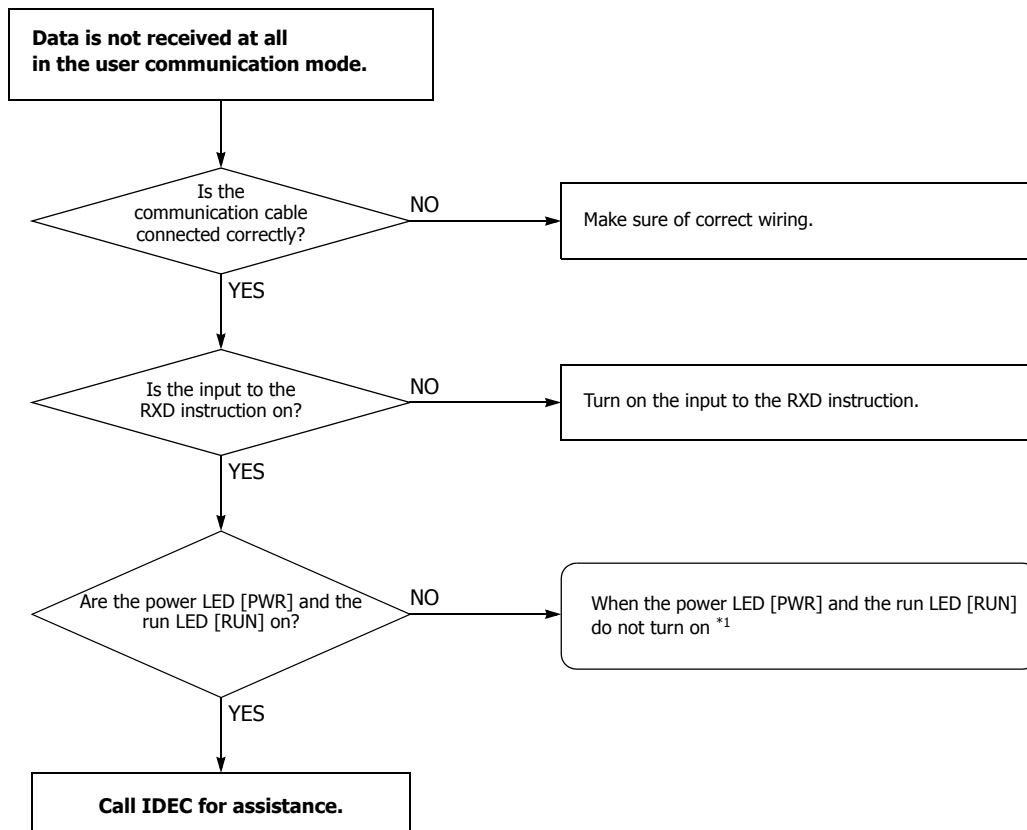

*1 See "The Power LED [PWR] is not On" on page 13-11 or "The Run LED [RUN] is not On" on page 13-12.

Troubleshooting Diagram 13

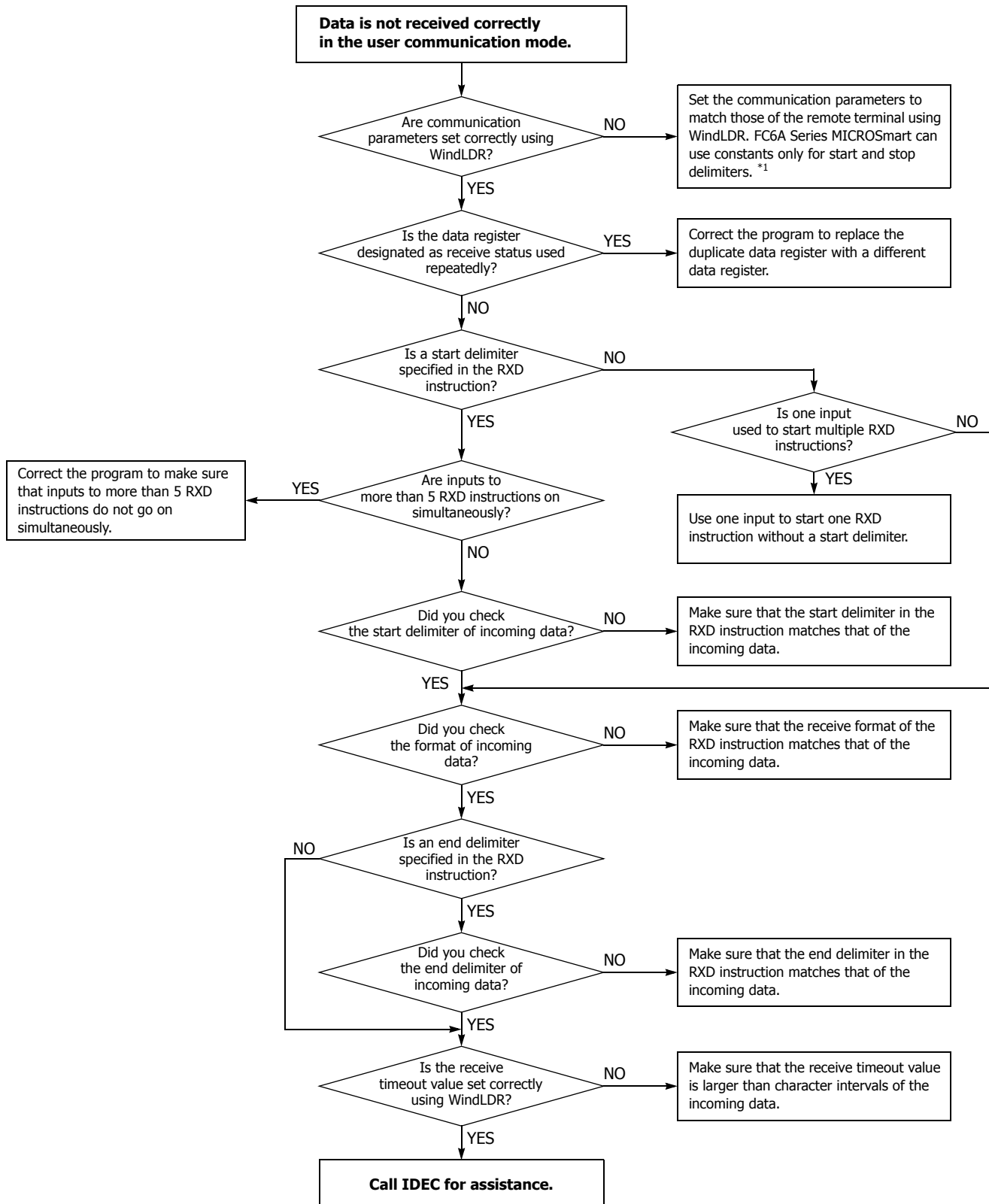

*1 See Chapter 5 "User Communication via Serial Communication" - "Programming WindLDR" in the "FC6A Series MICROSmart Communication Manual".

If the user communication still has a problem after completing the above procedure, also perform the procedure of Diagram 12 described on the preceding page.

Troubleshooting Diagram 14

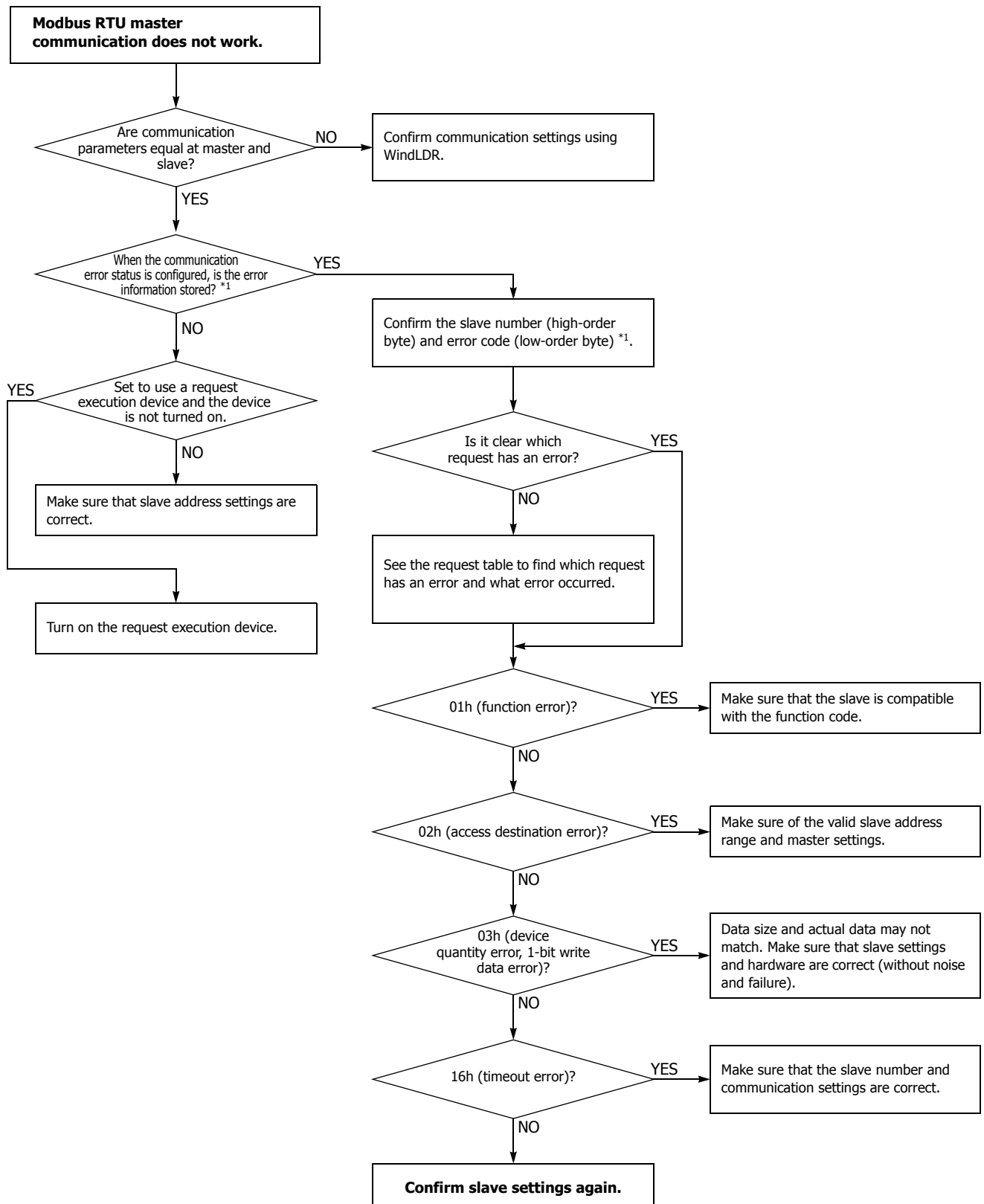

*1 See Chapter 6 "Modbus RTU Master Communication" - "Communication Completion and Communication Error" in the "FC6A Series MICROSmart Communication Manual".

Troubleshooting Diagram 15

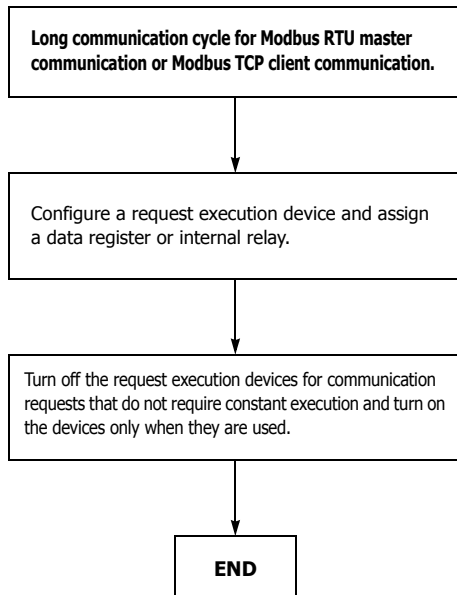

Troubleshooting Diagram 16

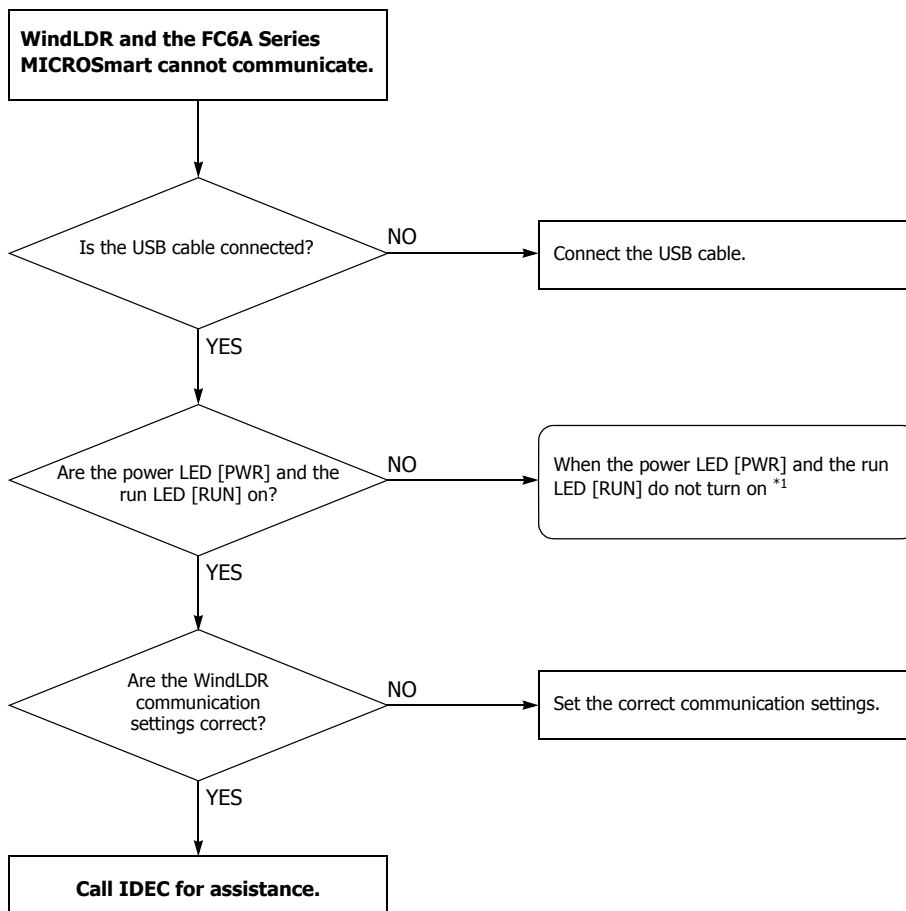

*1 See "The Power LED [PWR] is not On" on page 13-11 or "The Run LED [RUN] is not On" on page 13-12.

Troubleshooting Diagram 17

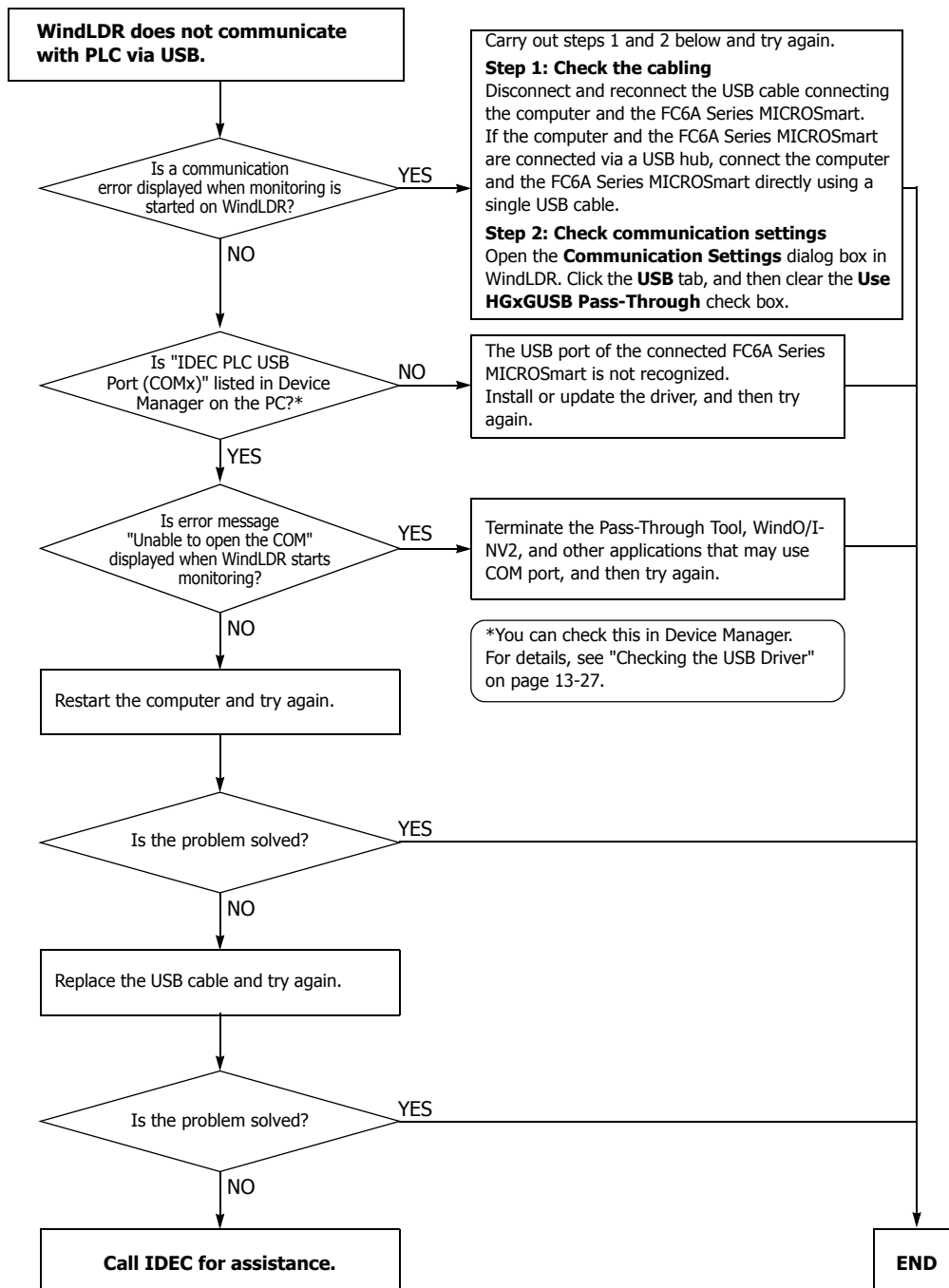

Troubleshooting Diagram 18

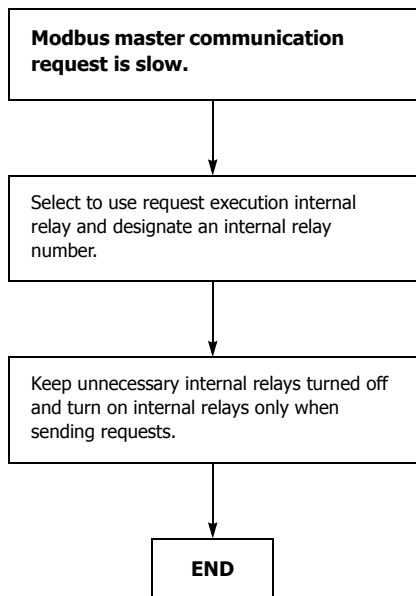

Checking the USB Driver

You can use the following procedure to check whether the USB driver has been installed correctly and whether the FC6A Series MICROSmart has been recognized correctly.

1. Display Device Manager.

- **Windows 10**

Right-click the **Start** button, and then click **Control Panel > Hardware and Sound**.
Under **Devices and Printers**, click **Device Manager**.

- **Windows 8**

On the Start screen, right-click the background, and then click **All apps > Control Panel > Hardware and Sound**.
In the **Hardware and Sound** dialog box, click **Device Manager**.

- **Windows 7**

Click the **Start** button > **Control Panel > System and Security > Device Manager**.

2. Click Ports (COM & LPT).

If the following device name is displayed, the USB driver has been installed correctly and the FC6A Series MICROSmart has been recognized correctly.

"IDEC PLC USB Port (COMx)"

Notes:

- The device name will disappear if you disconnect the USB cable or turn off the FC6A Series MICROSmart.
- If "Unknown device" is displayed for the device name or if a question mark is displayed when the FC6A Series MICROSmart is on and the USB cable is connected, the USB driver may not have been recognized correctly. Remove the USB cable, turn the FC6A Series MICROSmart off, turn the FC6A Series MICROSmart on again and connect it, and then check if the USB driver is recognized. If the USB driver still is not recognized, use Device Manager to delete the USB driver, and then reinstall it.

APPENDIX

This appendix describes information such as a list of FC6A Series MICROSmart types, how to update the software, and how to install the USB driver.

Type List

This section describes the types of FC6A Series MICROSmart modules, maintenance parts, manuals, and optional cables (sold separately).

CPU Modules

All-in-One CPU Modules

Power Voltage	Input Type	Output Type	I/O Points (Input Points/ Output Points)	Type No.	Terminal Specification
100-240V AC 24V DC	24V DC input shared sink/source	Relay output, 2 A/point	16 (9/7)	FC6A-C16R1AE	Removable terminal block (5.08 mm pitch)
				FC6A-C16R4AE	
			24 (14/10)	FC6A-C24R1AE	
				FC6A-C24R4AE	
			40 (24/16)	FC6A-C40R1AE	
				FC6A-C40R4AE	
			16 (9/7)	FC6A-C16R1CE	
				FC6A-C16R4CE	
			24 (14/10)	FC6A-C24R1CE	
				FC6A-C24R4CE	
			40 (24/16)	FC6A-C40R1CE	
				FC6A-C40R4CE	
24V DC	24V DC input shared sink/source	Transistor sink output 24V DC, 0.5 A/point	16 (9/7)	FC6A-C16K1CE	Removable terminal block (5.08 mm pitch)
				FC6A-C16K4CE	
			24 (14/10)	FC6A-C24K1CE	
				FC6A-C24K4CE	
			40 (24/16)	FC6A-C40K1CE	
				FC6A-C40K4CE	
		Transistor protection source output 24V DC, 0.5 A/point	16 (9/7)	FC6A-C16P1CE	
				FC6A-C16P4CE	
			24 (14/10)	FC6A-C24P1CE	
				FC6A-C24P4CE	
			40 (24/16)	FC6A-C40P1CE	
				FC6A-C40P4CE	
12V DC	12V DC input shared sink/source	Relay output, 2 A/point	16 (9/7)	FC6A-C16R1DE	Removable terminal block (5.08 mm pitch)
				FC6A-C16R4DE	
			40 (24/16)	FC6A-C40R1DE	
				FC6A-C40R4DE	
		Transistor sink output 12V DC, 0.5 A/point	16 (9/7)	FC6A-C16K1DE	
				FC6A-C16K4DE	
			40 (24/16)	FC6A-C40K1DE	
				FC6A-C40K4DE	
		Transistor protection source output 12V DC, 0.5A/point	16 (9/7)	FC6A-C16P1DE	
				FC6A-C16P4DE	
			40 (24/16)	FC6A-C40P1DE	
				FC6A-C40P4DE	

*1 Screw fastened type

*2 Push-in type

CAN J1939 All-in-One CPU Modules

Power Voltage	Input Type	Output Type	I/O Points (Input Points/ Output Points)	Type No.	Terminal Specification
100-240V AC	24V DC input shared sink/source	Relay output, 2 A/point	40 (24/16)	FC6A-C40R1AEJ	*1
24V DC				FC6A-C40R4AEJ	*2
		FC6A-C40R1CEJ		*1	
		FC6A-C40R4CEJ		*2	
		FC6A-C40K1CEJ		*1	
		FC6A-C40K4CEJ		*2	
		FC6A-C40P1CEJ		*1	
FC6A-C40P4CEJ		*2			
12V DC	12V DC input shared sink/source	Relay output, 2 A/point	40 (24/16)	FC6A-C40R1DEJ	*1
				FC6A-C40R4DEJ	*2
		FC6A-C40K1DEJ		*1	
		FC6A-C40K4DEJ		*2	
		FC6A-C40P1DEJ		*1	
		FC6A-C40P4DEJ		*2	

*1 Screw fastened type

*2 Push-in type

Plus CPU Modules

Power Voltage	Input Type	Output Type	I/O Points (Input Points/ Output Points)	Type No.	Terminal Specification
24V DC	24V DC input shared sink/source	Relay output, 2 A/point	16 (8/8)	FC6A-D16R1CEE	*1
				FC6A-D16R4CEE	*2
		FC6A-D16K1CEE		*1	
		FC6A-D16K4CEE		*2	
		FC6A-D16P1CEE		*1	
		FC6A-D16P4CEE		*2	
		32 (16/16)	Transistor sink output 24V DC, 0.5 A/point	FC6A-D32K3CEE	*3
				FC6A-D32K4CEE	*4
				FC6A-D32P3CEE	*3
				FC6A-D32P4CEE	*4

*1 Screw fastened type

*2 Push-in type

*3 Screw fastened type (Power supply terminals)

*4 Push-in type (Power supply terminals)

Expansion Modules

Digital I/O Modules

Input Type	Output Type	I/O Points (Input Points/ Output Points)	Type No.	Terminal Specification		
12/24V DC input*1 shared sink/source	—	8 (8/0)	FC6A-N08B1	Removable terminal block (5.08 mm pitch)	*2	
			FC6A-N08B4		*3	
		16 (16/0)	FC6A-N16B1	Removable terminal block (3.81 mm pitch)	*2	
			FC6A-N16B4		*3	
16 (16/0)	FC6A-N16B3	20-pin MIL connector				
32 (32/0)	FC6A-N32B3					
100-120V AC input	—	8 (8/0)	FC6A-N08A11	Removable terminal block (5.08 mm pitch)	*2	
			FC6A-N08A14		*3	
—	Relay output, 2 A/point	8 (0/8)	FC6A-R081	Removable terminal block (5.08 mm pitch)	*2	
			FC6A-R084		*3	
		16 (0/16)	FC6A-R161	Removable terminal block (3.81 mm pitch)	*2	
			FC6A-R164		*3	
	Transistor sink output 12/24V DC, 0.5 A/point*1	8 (0/8)	FC6A-T08K1	Removable terminal block (5.08 mm pitch)	*2	
			FC6A-T08K4		*3	
	Transistor protection source output 24V DC, 0.5 A/point	8 (0/8)	FC6A-T08P1		*2	
			FC6A-T08P4		*3	
	Transistor sink output 12/24V DC, 0.5 A/point*1	16 (0/16)	FC6A-T16K1	Removable terminal block (3.81 mm pitch)	*2	
			FC6A-T16K4		*3	
	Transistor protection source output 24V DC, 0.5 A/point	16 (0/16)	FC6A-T16P1		*2	
			FC6A-T16P4		*3	
Transistor sink output 12/24V DC, 0.1 A/point*1	16 (0/16)	FC6A-T16K3	20-pin MIL connector			
		FC6A-T16P3				
	32 (0/32)	FC6A-T32K3				
		FC6A-T32P3				
24V DC input shared sink/source	Relay output, 2 A/point	8 (4/4)		FC6A-M08BR1	Removable terminal block (5.08 mm pitch)	*2
				FC6A-M08BR4		*3
		24 (16/8)	FC6A-M24BR1	Removable terminal block (3.81 mm pitch)	*2	
			FC6A-M24BR4		*3	

*1 24V DC input for products with a version number lower than V400. For details on the version number of modules, see "Checking the Version Number" on page 2-1.

*2 Screw fastened type

*3 Push-in type

APPENDIX

Analog I/O Modules

Power Voltage	Input Type	Output Type	I/O Points (Input Points/ Output Points)	Type No.	Terminal Specification	
12/24V DC	Analog input (voltage/current)	—	2 (2/0)	FC6A-J2C1	Removable terminal block (5.08 mm pitch)	*1
				FC6A-J2C4		*2
			4 (4/0)	FC6A-J4A1	Removable terminal block (3.81 mm pitch)	*1
				FC6A-J4A4		*2
			8 (8/0)	FC6A-J8A1	Removable terminal block (3.81 mm pitch)	*1
				FC6A-J8A4		*2
—	Analog output (voltage/current)	2 (0/2)	FC6A-K2A1	Removable terminal block (5.08 mm pitch)	*1	
			FC6A-K2A4		*2	
24V DC	—	Analog output (voltage/current)	4 (0/4)	FC6A-K4A1	Removable terminal block (5.08 mm pitch)	*1
				FC6A-K4A4		*2
	Analog input (voltage/current)	Analog output (voltage/current)	6 (4/2)	FC6A-L06A1	Removable terminal block (3.81 mm pitch)	*1
				FC6A-L06A4		*2
12/24V DC	Analog input (voltage/current/ thermocouple/resistance thermometer)	Analog output (voltage/current)	3 (2/1)	FC6A-L03CN1	Removable terminal block (5.08 mm pitch)	*1
				FC6A-L03CN4		*2
	Analog input (voltage/current/ thermocouple/resistance thermometer)	—	4 (4/0)	FC6A-J4CN1	Removable terminal block (3.81 mm pitch)	*1
				FC6A-J4CN4		*2
	Analog input (thermocouple)	—	4 (4/0)	FC6A-J4CH1Y	Removable terminal block (3.81 mm pitch)	*1
				FC6A-J4CH4Y		*2
	Analog input (thermocouple/ thermistor/resistance)	—	8 (8/0)	FC6A-J8CU1	Removable terminal block (3.81 mm pitch)	*1
				FC6A-J8CU4		*2

*1 Screw fastened type

*2 Push-in type

PID Modules

Power Voltage	Input Type	Output Type	I/O Points (Input Points/ Output Points)	Type No.	Terminal Specification	
24V DC	Analog input (voltage/current/ thermocouple/resistance thermometer)	Relay output 240V AC, 2 A/30V DC, 2 A	4 (2/2)	FC6A-F2MR1	Removable terminal block (3.81 mm pitch)	*1
				FC6A-F2MR4		*2
	Analog input (voltage/current/ thermocouple/resistance thermometer)	Transistor source output 12V DC/analog output (current)	4 (2/2)	FC6A-F2M1	Removable terminal block (3.81 mm pitch)	*1
				FC6A-F2M4		*2

*1 Screw fastened type

*2 Push-in type

Communication Module

Name	Function/purpose	I/O Points (Input Points/ Output Points)	Type No.	Terminal Specification
Communication module	RS232C/RS485 communication	—	FC6A-SIF52	Direct-mounting terminal block (3.81 mm pitch)
			FC6A-SIF524	

*1 Screw fastened type

*2 Push-in type

Expansion Interface Modules

Power Voltage	Name	Function/purpose	I/O Points (Input Points/ Output Points)	Type No.	Terminal Specification	
24V DC	Expander	Increases the number of expansion modules that can be connected	—	FC6A-EXM2	Removable terminal block (5.08 mm pitch)	*1
	FC6A-EXM24			*2		
	Remote master		—	FC6A-EXM1M	—	
	Remote slave		—	FC6A-EXM1S FC6A-EXM1S4	Removable terminal block (5.08 mm pitch)	*1 *2

*1 Screw fastened type

*2 Push-in type

HMI Module

Name	Function/purpose	I/O Points (Input Points/ Output Points)	Type No.	Terminal Specification
HMI module	HMI module with web server function	—	FC6A-PH1	—

Cartridge Base Module

Name	Function/purpose	I/O Points (Input Points/ Output Points)	Type No.	Terminal Specification
Cartridge base module	Expands cartridge slots for the Plus CPU module	—	FC6A-HPH1	—

Cartridges

Name	Function/purpose	I/O Points (Input Points/ Output Points)	Type No.	Terminal Specification
Digital I/O cartridge	12/24V DC input shared sink/source	4 (4/0)	FC6A-PN4	Direct-mounting terminal block (3.81 mm pitch)
	Transistor sink output 12/24V DC, 0.1 A/point	4 (0/4)	FC6A-PTK4	Direct-mounting terminal block (3.81 mm pitch)
	Transistor protection source output 12/24V DC, 0.1 A/point	4 (0/4)	FC6A-PTS4	Direct-mounting terminal block (3.81 mm pitch)
Analog I/O cartridge	Analog input (voltage/current)	2 (2/0)	FC6A-PJ2A	Direct-mounting terminal block (3.81 mm pitch)
	Analog input (thermocouple/resistance thermometer)	2 (2/0)	FC6A-PJ2CP	Direct-mounting terminal block (3.81 mm pitch)
	Analog output (voltage)	2 (0/2)	FC6A-PK2AV	Direct-mounting terminal block (3.81 mm pitch)
	Analog output (current)	2 (0/2)	FC6A-PK2AW	Direct-mounting terminal block (3.81 mm pitch)
Communication cartridge	RS232C communication	—	FC6A-PC1	Direct-mounting terminal block (3.81 mm pitch)
	RS485 communication	—	FC6A-PC3	Direct-mounting terminal block (3.81 mm pitch)
	Bluetooth communication	—	FC6A-PC4	—

Maintenance Parts

Type	Type No.	Specifications
FC6A Series CPU module connector with analog input cable	FC4A-PMAC2PN02	Cable length: 1 m (3.28 feet) (2 items) Compatible with the FC4A Slim Type, the FC5A Slim Type, and the FC6A Series MICROSmart
FC6A Series CPU module mounting hook FC6A Series HMI module mounting hook	FC6A-PSP1PN05	Direct/DIN-rail mounting hook (5 items)
FC6A Series expansion module mounting hook FC6A Series expansion interface module mounting hook	FC6A-PSP2PN05	Direct/DIN-rail mounting hook (5 items)
FC6A Series CPU module power supply terminal block connector	FC6A-PMTD03PN02	5.08 mm pitch, 3-pin, screw fastened type (2 items)*1
FC6A Series expansion interface module power supply terminal block connector	FC6A-PMTB03PN02	5.08 mm pitch, 3-pin, screw fastened type (2 items)*1
FC6A Series CPU module, CAN J1939 All-in-One CPU module CAN communication terminal block connector	FC6A-PMTE05PN02	5.08 mm pitch, 5-pin, screw fastened type (2 items)*1
FC6A Series CPU module removable terminal block	FC6A-PMTA08PN02	5.08 mm pitch, 8-pin, screw fastened type (2 items)*1
	FC6A-PMTA09PN02	5.08 mm pitch, 9-pin, screw fastened type (2 items)*1
	FC6A-PMTA10PN02	5.08 mm pitch, 10-pin, screw fastened type (2 items)*1
	FC6A-PMTA12PN02	5.08 mm pitch, 12-pin, screw fastened type (2 items)*1
	FC6A-PMTA13PN02	5.08 mm pitch, 13-pin, screw fastened type (2 items)*1
FC6A Series Plus CPU module inputs removable terminal block	FC6A-PMSCN10PN02	3.81 mm pitch, 10-pin, push-in type (2 items)
	FC6A-PMTCN10PN02	5.08 mm pitch, 10-pin, screw fastened type (2 items)*1
FC6A Series Plus CPU module relay outputs removable terminal block	FC6A-PMSCR11PN02	3.81 mm pitch, 11-pin, push-in type (2 items)
	FC6A-PMTCR11PN02	5.08 mm pitch, 11-pin, screw fastened type (2 items)*1
FC6A Series Plus CPU module sink outputs removable terminal block	FC6A-PMSCK11PN02	3.81 mm pitch, 11-pin, push-in type (2 items)
	FC6A-PMTCCK11PN02	5.08 mm pitch, 11-pin, screw fastened type (2 items)*1
FC6A Series Plus CPU module protection source outputs removable terminal block	FC6A-PMSCP11PN02	3.81 mm pitch, 11-pin, push-in type (2 items)
	FC6A-PMTCP11PN02	5.08 mm pitch, 11-pin, screw fastened type (2 items)*1
FC6A Series Plus CPU module power supply removable terminal block	FC6A-PMSDC03PN02	5.08 mm pitch, 3-pin, push-in type (2 items)
FC6A Series expansion module removable terminal block	FC6A-PMSB11PN02	5.08 mm pitch, 11-pin, push-in type (2 items)
	FC6A-PMSC10PN02	3.81 mm pitch, 10-pin, push-in type (2 items)
	FC6A-PMSC11PN02	3.81 mm pitch, 11-pin, push-in type (2 items)
	FC6A-PMSC17PN02	3.81 mm pitch, 17-pin, push-in type (2 items)
FC6A Series expansion interface module removable terminal block	FC6A-PMTB11PN02	5.08 mm pitch, 11-pin, screw fastened type (2 items)*1
	FC6A-PMTC10PN02	3.81 mm pitch, 10-pin, screw fastened type (2 items)*1
	FC6A-PMTC11PN02	3.81 mm pitch, 11-pin, screw fastened type (2 items)*1
	FC6A-PMTC17PN02	3.81 mm pitch, 17-pin, screw fastened type (2 items)*1
FC6A Series expansion interface module power supply removable terminal block	FC6A-PMSB03PN02	5.08 mm pitch, 3-pin, push-in type (2 items)
FC6A Series CPU module battery holder	FC6A-BH1PN02	Battery holder (2 items)

*1 Appropriate screw fastened type removable terminal blocks are contained in the purchased modules.

Manuals

Type	Type No.	Specifications
FC6A Series MICROSmart User's Manual	FC9Y-B1721	Japanese
	FC9Y-B1722	English
	FC9Y-B1723	Chinese (PDF manual only)
FC6A Series MICROSmart Ladder Programming Manual	FC9Y-B1725	Japanese
	FC9Y-B1726	English
	FC9Y-B1727	Chinese (PDF manual only)
FC6A Series MICROSmart Communication Manual	FC9Y-B1729	Japanese
	FC9Y-B1730	English
	FC9Y-B1731	Chinese (PDF manual only)
FC6A Series MICROSmart PID Module User's Manual	FC9Y-B1733	Japanese
	FC9Y-B1734	English
	FC9Y-B1735	Chinese (PDF manual only)

Application Software

Product Name	Type No.	Specifications
Automation Organizer	SW1A-W1C	Package software containing the programming software "WindLDR"

Option Cables (Sold Separately)

Product Name	Type No.	Function
Shielded flat I/O cable (0.5 m [1.64 feet])	FC9Z-H050A20	Shielded, 20-pin straight cable for use with I/O modules This can be used with IDEC I/O terminals. The type numbers of the supported I/O terminals are shown below. BX1D-□20A,*1 BX1F-□20A,*1 BX7D-BT16A1T (16-point relay output)
Shielded flat I/O cable (1 m [3.28 feet])	FC9Z-H100A20	
Shielded flat I/O cable (2 m [6.56 feet])	FC9Z-H200A20	
Shielded flat I/O cable (3 m [9.84 feet])	FC9Z-H300A20	
Non-shielded flat I/O cable (0.5 m [1.64 feet])	FC9Z-H050B20	Non-shielded, 20-pin straight cable for use with I/O modules This can be used with IDEC I/O terminals. The type numbers of the supported I/O terminals are shown below. BX1D-□20A,*1, BX1F-□20A,*1, BX7D-BT16A1T (16-point relay output)
Non-shielded flat I/O cable (1 m [3.28 feet])	FC9Z-H100B20	
Non-shielded flat I/O cable (2 m [6.56 feet])	FC9Z-H200B20	
Non-shielded flat I/O cable (3 m [9.84 feet])	FC9Z-H300B20	
External device/O/I communication cable	FC6A-KC1C	Cable for connecting external devices, IDEC displays (HG4G/3G/2G), and general-purpose display devices (cable length: 5 m [16.4 feet]) RJ45 connector/loose wires (1 item)
O/I communication cable	FC6A-KC2C	Cable dedicated for connecting IDEC displays (HG4G/3G/2G ^{*2}) (cable length: 5 m [16.4 feet]) RJ45 connector/D-sub 9-pin connector (1 item)

*1 The "□" in the I/O terminal type numbers indicates the terminal shape.

T: Touch-down terminal block, S: Captive screw terminal block

*2 Use the FC6A-KC1C for products other than the HG2G-5FT22TF Series.

Options (Sold Separately)

Product Name	Function	Type No.	Comments
35 mm wide DIN rail (length: 1,000 mm)	Aluminum, used when mounting on DIN rail	BAA1000PN10	10 items
35 mm wide DIN rail (length: 1,000 mm)	Steel, used when mounting on DIN rail	BAP1000PN10	10 items
Bracket	Used to fix CPU modules, expansion modules, and HMI modules on a rail	BNL6PN10	10 items
20-pin connector	20-pin MIL connector for an expansion module	FC4A-PMC20PNO2	2 items
USB maintenance cable Cable length: 2 m (6.7 feet)	USB cable used to connect the PC and the PLC <Connector> A: mini B	HG9Z-XCM42	1 item
USB-mini B port extension cable (cable length: 1 m [3.28 feet])	USB cable used to extend the USB-mini B port to the panel surface	HG9Z-XCE21	1 item
USB cable retention pin	Used to keep the USB cable constantly connected	HG9Z-XU1PN05	5 items
Replacement battery for CPU module	CR2032W backup battery (1 battery is included with the PLC unit.)	HG9Z-XR2	1 item ^{*1}

*1 Sold in Japan only.

Recommended Products (Sold Separately)

Product Name	Function	Reference
Panasonic: BR2032/CR2032A/CR2032B, Murata: CR2032X/CR2032W	Backup battery	—
Ferrule manufactured by Phoenix Contact or Weidmüller (1 cable)	Ferrule used to wire the terminal block	3-46
Ferrule manufactured by Phoenix Contact or Weidmüller (2 cables)	Ferrule used to wire the terminal block	
Ferrule tool manufactured by Phoenix Contact or Weidmüller	Ferrule crimping tool	
Screwdriver	Screwdriver used to wire the terminal block	

System Software

This section explains how to update the FC6A Series MICROSmart to the latest system software.

Getting the Latest Version of the System Software

When you install or upgrade to the latest version of Automation Organizer, the latest system software is also available along with the software.

Checking the Version

You can check the FC6A Series MICROSmart system software version with the following steps.

1. Connect the computer to the FC6A Series MICROSmart USB port with the USB maintenance cable (HG9Z-XCM42). For details, see the "FC6A Series MICROSmart Communication Manual".
2. From the WindLDR menu bar, select **Online > Monitor > Start Monitor**. WindLDR enters monitor mode.
3. Select **Online > PLC > Status**. The **PLC Status** dialog box is displayed.

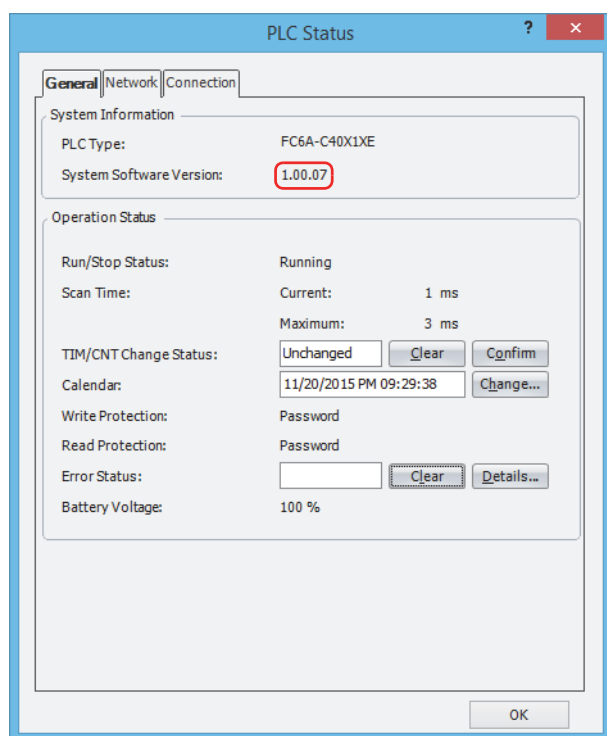

You can check the FC6A Series MICROSmart system software version with **System Software Version**.

Note: FC6A Series MICROSmart system software downloads can be executed from WindLDR.

For how to download the system software, see "Upgrade FC6A Series MICROSmart System Software" on page A-10.

Upgrade FC6A Series MICROSmart System Software

The system software of FC6A Series MICROSmart can be upgraded using WindLDR. If the system software of your FC6A Series MICROSmart is old, upgrade the system software with the following procedure:

1. Connect the computer to the FC6A Series MICROSmart USB port, Ethernet port 1, or serial port 1.
For details, see the "FC6A Series MICROSmart Communication Manual".
2. From the WindLDR menu bar, select **Online > Download > System Software Download**.

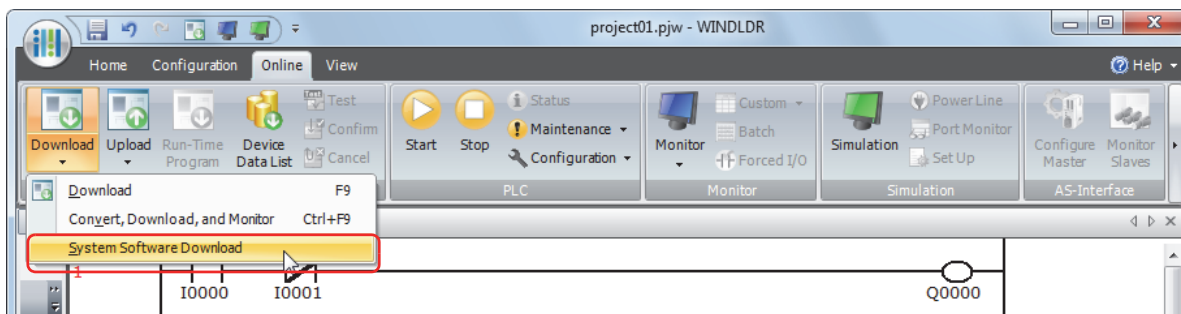

The System Software Download dialog box appears.

3. Select the PLC type of the CPU module that will perform the download, the target module, and the system software version to download, and then click **Start System Software Download**.

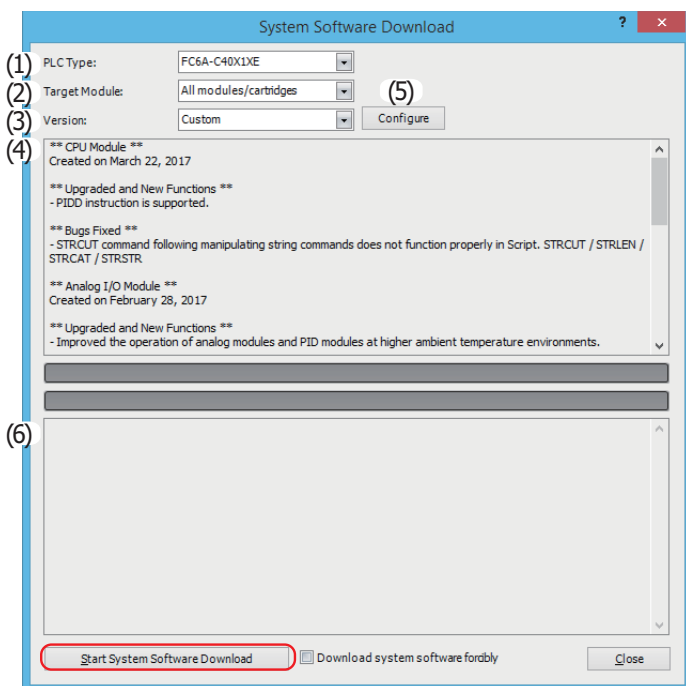

No.	Item Name	Description
(1)	PLC Type	Select the PLC type of the CPU module.
(2)	Target Module	Select the module for downloading the system software from those shown below. All modules, CPU module, Digital I/O module*¹, Analog I/O module, PID module, HMI module, Communication module, Expansion interface remote master module, Expansion interface remote slave module, Bluetooth communication cartridge. All modules is selected by default.
(3)	Version	Select the system software version. If you have selected All modules for Target Module , select from Update all and Custom . If you have selected a value other than All modules for Target Module , select the version to download to the selected module.
(4)	Revision history	The revision history related to the system software of the CPU module selected in the System Software Version Selection dialog box is displayed here.

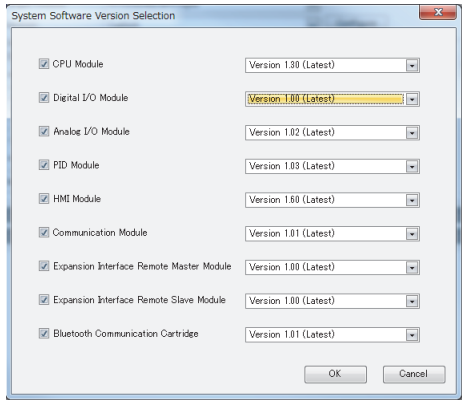
No.	Item Name	Description
(5)	Configure button	<p>If you select Custom for Version, click this button to display the System Software Version Selection dialog box, which you can use to specify the module to download the system software to and the system software version. Select all the check boxes for the modules to download the system software to. Select the system software version for each module, and then click OK.</p> 
(6)	Status display	<p>The success or failure of the system software download for each target module is displayed here. The slot position and the PLC type are both displayed for analog I/O modules and PID modules.</p>

*1 In the following cases, the system software cannot be downloaded to the digital I/O module.

- If the hardware version of the digital I/O module is V110 or earlier
For details on the hardware version, see "Checking the Hardware Version Number" on page 9-2.
- If the digital I/O module is connected after the FC6A-EXM1S or FC6A-EXM1S4
- If the system software version of the FC6A All-in-One CPU module or CAN J1939 All-in-One CPU module is 1.90 or earlier, or if the system software version of the FC6A Plus CPU module is 1.31 or earlier

Notes:

- If the FC6A Series MICROSmart is running, it is stopped automatically before the system software download starts.
- Older system software can also be downloaded to the FC6A Series MICROSmart if required.
- The system software download takes about one minute.

4. A confirmation message is displayed. Click **Yes** to start downloading the system software.

5. System software download status is shown by a progress bar. A completion message appears when the system software has been downloaded successfully. Click **OK** to close the System Software Download dialog box.

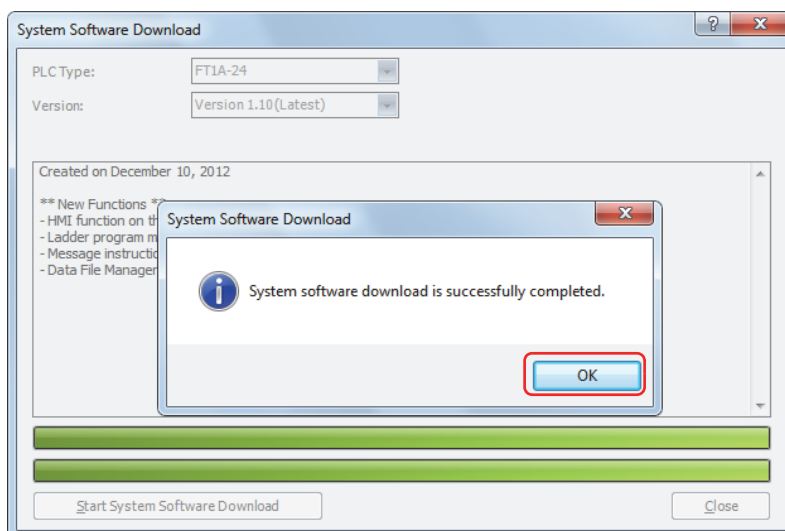

Notes:

- For the FC6A Series MICROSmart, its backlight will flash while the system software is downloading.
- After the system software has downloaded, the FC6A Series MICROSmart will be in the STOP state. Use WindLDR operations, FC6A Series MICROSmart function switch operations, or HMI module LCD operations to run the FC6A Series MICROSmart.
- The user program stored in the FC6A Series MICROSmart before downloading the system software remains and is executed when the FC6A Series MICROSmart is restarted. A user program execution error may occur if an older system software is downloaded to the FC6A Series MICROSmart.
- If the system software download fails, download it again.

Fonts

This section describes the fonts that can be displayed on the HMI module LCD.

Supported Languages

The HMI module is equipped with fonts for multiple languages as standard. Messages in the language selected with the MSG instruction can be displayed on the LCD.

The menu can be displayed in English, Chinese, or Japanese, and messages can be displayed in a desired language out of the following languages: German, English, Italian, Spanish, Dutch, French, Cyrillic, Chinese, and Japanese.

Installed Fonts List

Setting name	Character code system	Supported languages
Western European	ISO8859-1 (Latin-1)	English, German, Italian, Spanish, Dutch (Note), French (Note)
Japanese	Shift-JIS	Japanese (level 1)
Chinese	GB2312	Chinese (simplified)
Cyrillic	ANSI1251	Russian

Note: Some of the characters cannot be input.

Character Code Table

Using the Character Code Table

Example: Finding the character code for the character "a" in the table.

	0	1	2	3	4	5	6	7	8	9	A	B	C	D	E	F	
0			0	@	P		p				°	À	Đ	à	ã		
1		!	1	^	Q	a	q				i	±	Á	Ñ	á	ñ	
2		"	2	B	R	b	r				∅	²	Â	Ò	â	ò	
:		#	3	C	S	c	s				£	³	Ã	Ó	ã	ó	

Lower 4 bits of the code (hexadecimal)

The upper 4 bits of the code are hexadecimal 6.

The lower 4 bits of the code are hexadecimal 1.

Therefore, the character code for "a" is as follows.

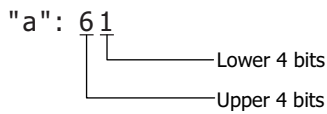

Note: For other fonts and two-byte characters, refer to the table of the relevant code system.

ASCII Character Code Table

	0	1	2	3	4	5	6	7
0				0	@	P	`	p
1			!	1	À	Q	a	q
2			"	2	B	R	b	r
3			#	3	C	S	c	s
4			\$	4	D	T	d	t
5			%	5	E	U	e	u
6			&	6	F	V	f	v
7			'	7	G	W	g	w
8			(8	H	X	h	x
9)	9	I	Y	i	y
A			*	:	J	Z	j	z
B			+	;	K	[k	{
C			,	<	L	\	l	
D			-	=	M]	m	}
E			.	>	N	^	n	~
F			/	?	O	_	o	

Cables

This section describes the wiring of external device/O/I communication cables and of O/I communication cables. When using external device/O/I communication cables and O/I communication cables to connect the FC6A Series MICROSmart to external devices and operator interfaces, refer to the following wiring diagrams.

External Device/O/I Communication Cable (Type No.: FC6A-KC1C, Cable Length: 5 m [16.4 Feet])

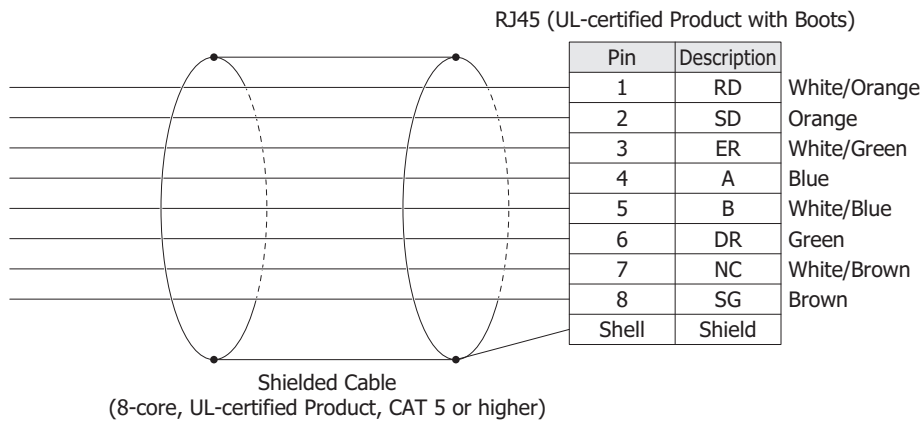

O/I Communication Cable (Type No.: FC6A-KC2C, Cable Length: 5 m [16.4 Feet])

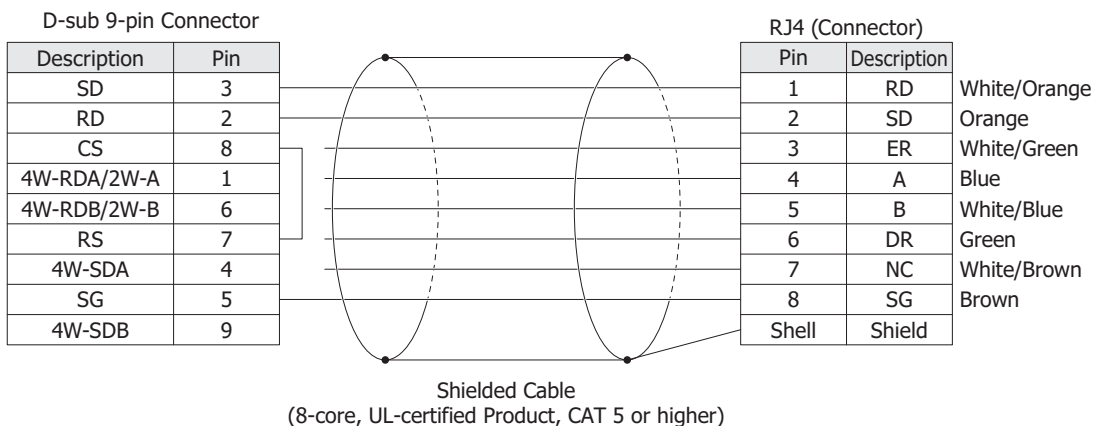
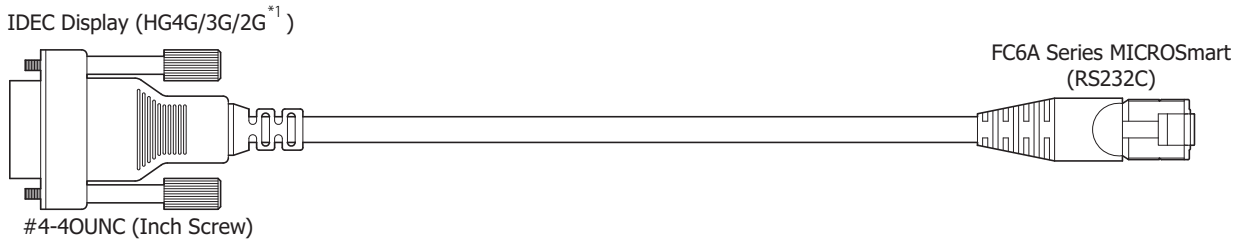

*1 Use the FC6A-KC1C for products other than the HG2G-5FT22TF Series.

Wiring Example

When Connecting the CPU Module via RS485

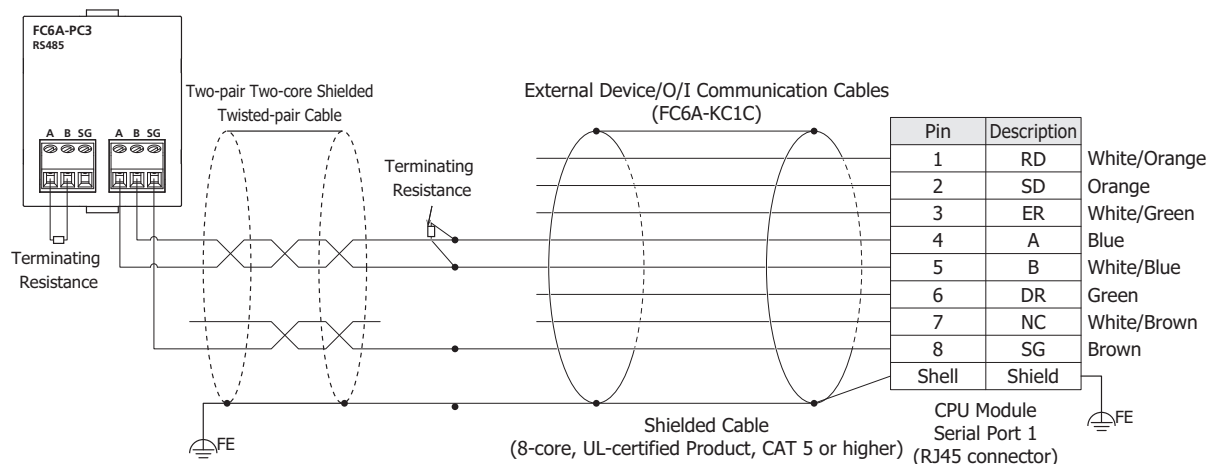

Wiring example when connecting CPU modules via RS485

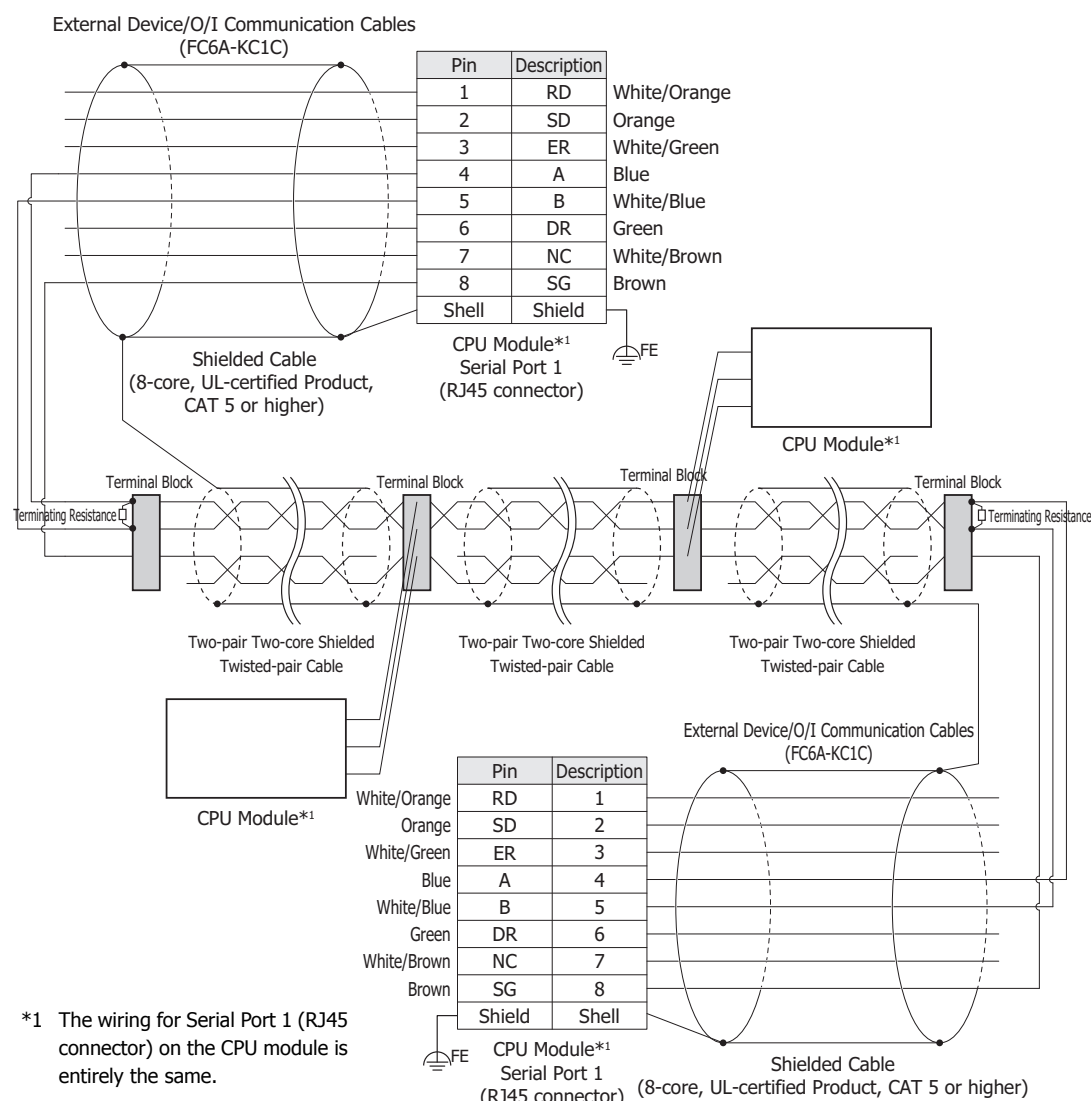

We do not recommend connecting the SG line using a shielded cable.

Since the shield of the "FC6A-KC1C external device/O/I connection cable" will be connected to FE (or PE) of the CPU module, one end of the shield will be grounded when connected to FE (or PE) of the CPU module.

When communication quality is unstable, add terminating resistance matched to the characteristic impedance to both ends of the cable. Use resistance with a rating of 1/2 W or higher.

HMI Screen Transition Diagram

This section describes the transitions between the screens displayed on the HMI module LCD.

System menu overall transition diagram

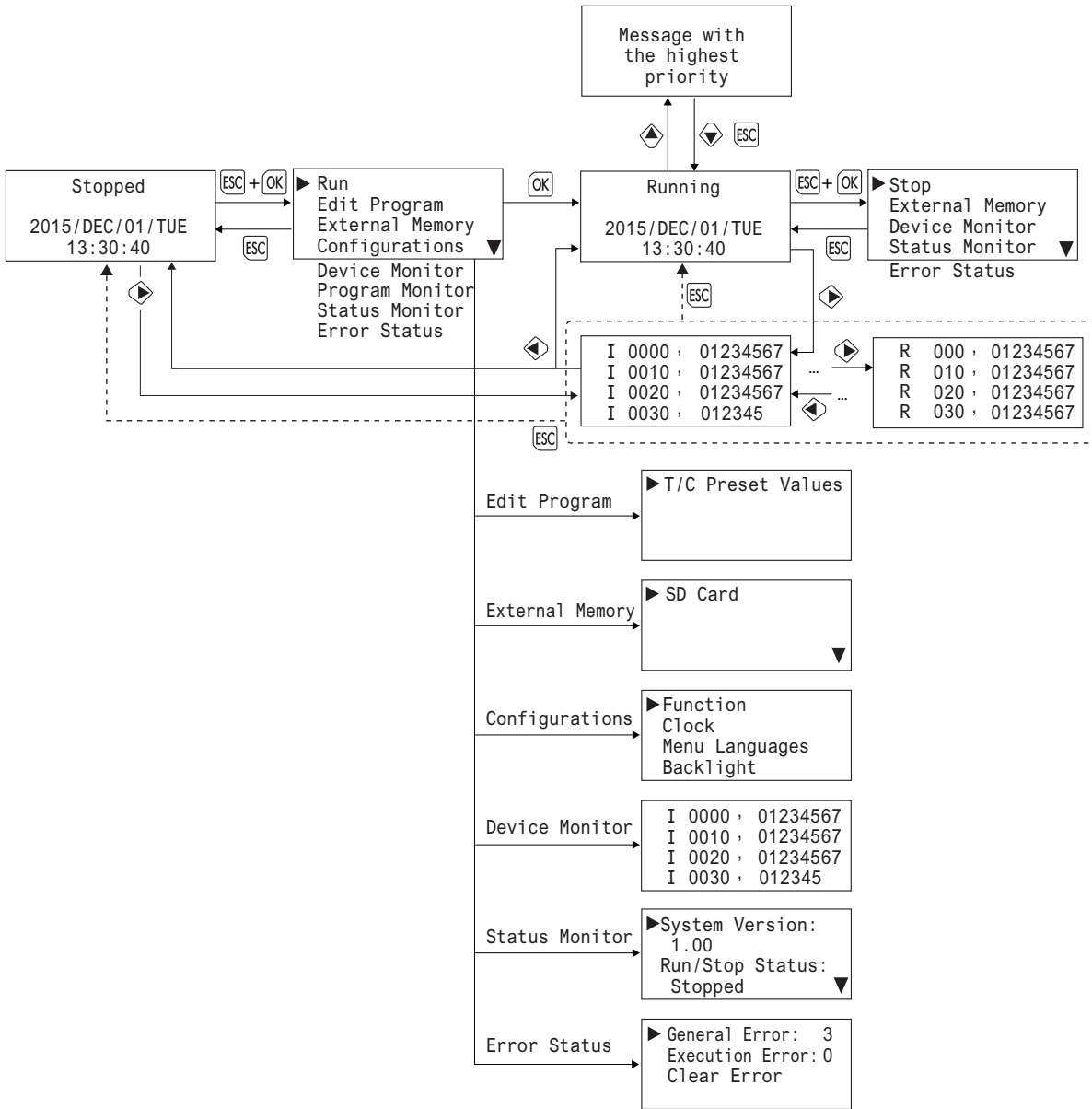

Switching run/stop

Running the user program

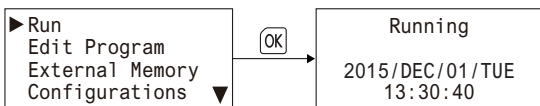

Stopping the user program

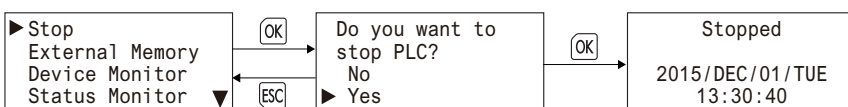

Writing/Clearing TP (Timer Preset Values) and CP (Counter Preset Values) in the User Program

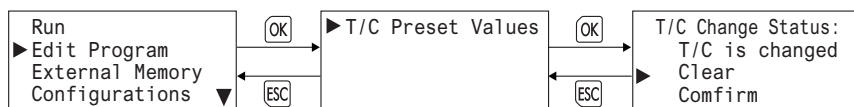

Stopping Access to the SD Memory Card/Formatting the SD Memory Card

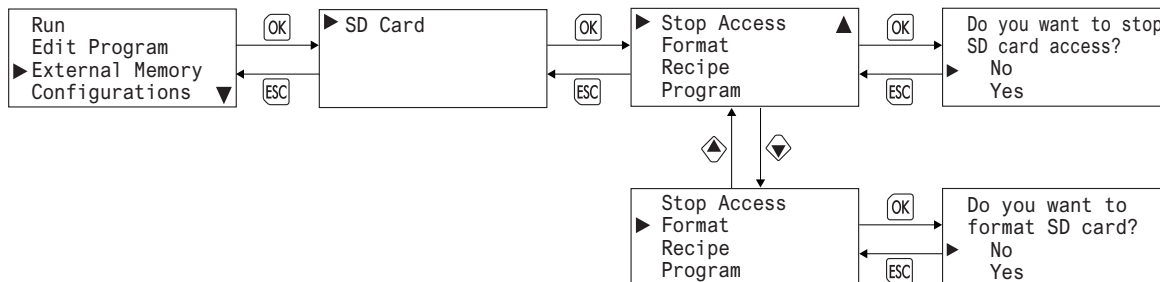

Configuring the Slave Number

□□□□ is displayed only when the Plus CPU module is connected.

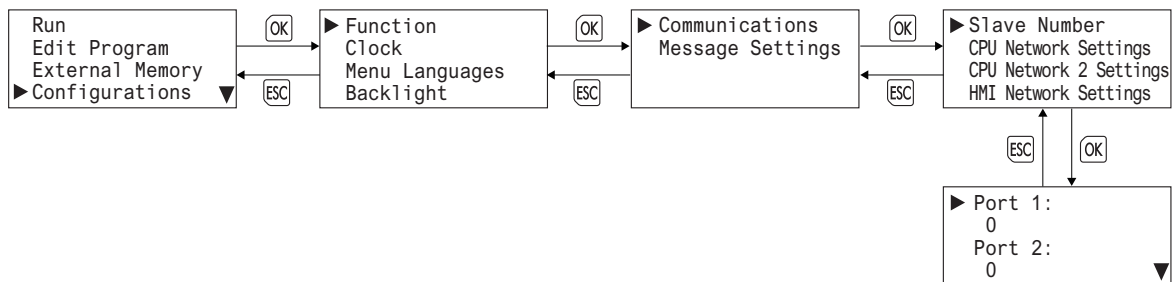

Configuring the Network Settings

⋯ is displayed only when the Plus CPU module is connected.

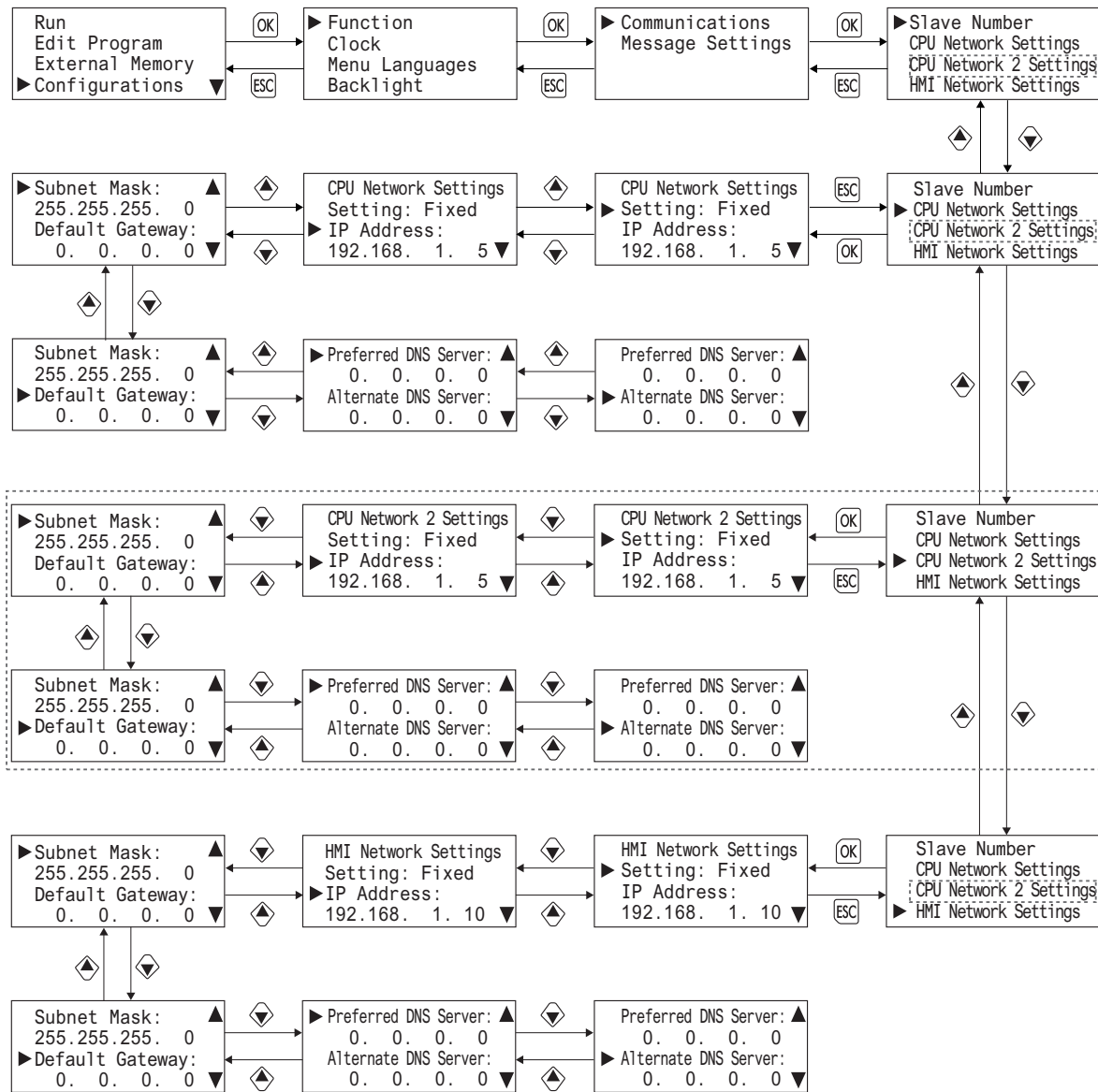

Modifying the Scroll Speed/Configuring the Scroll Unit

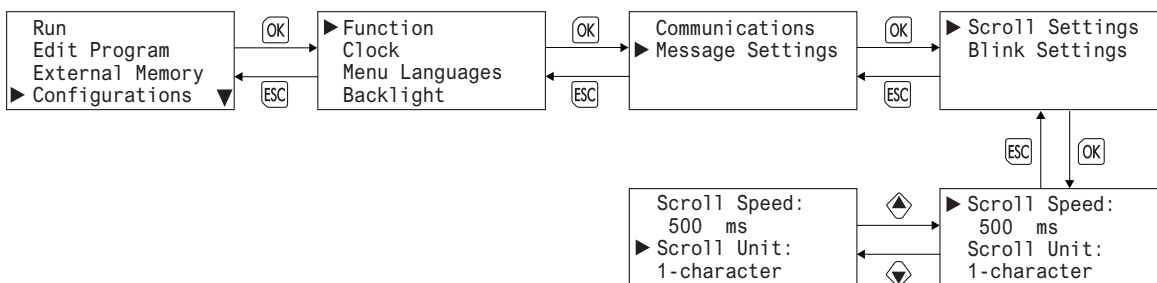

Configuring the Blinking Speed

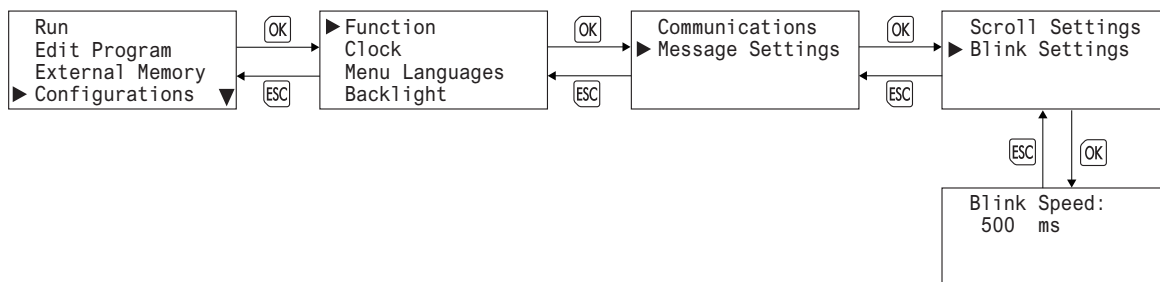

Setting the Calendar/Clock

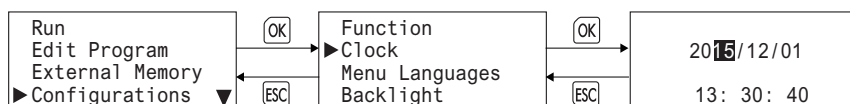

Changing the Menu Language

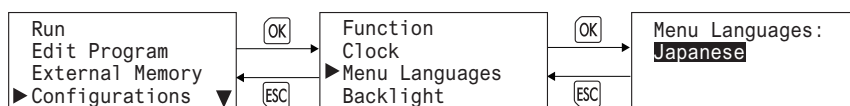

Setting the LCD Backlight ON Time

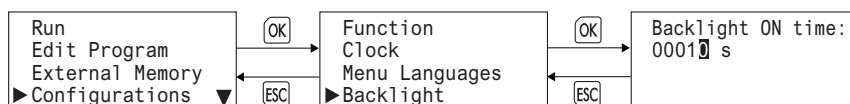

Monitoring Device Values

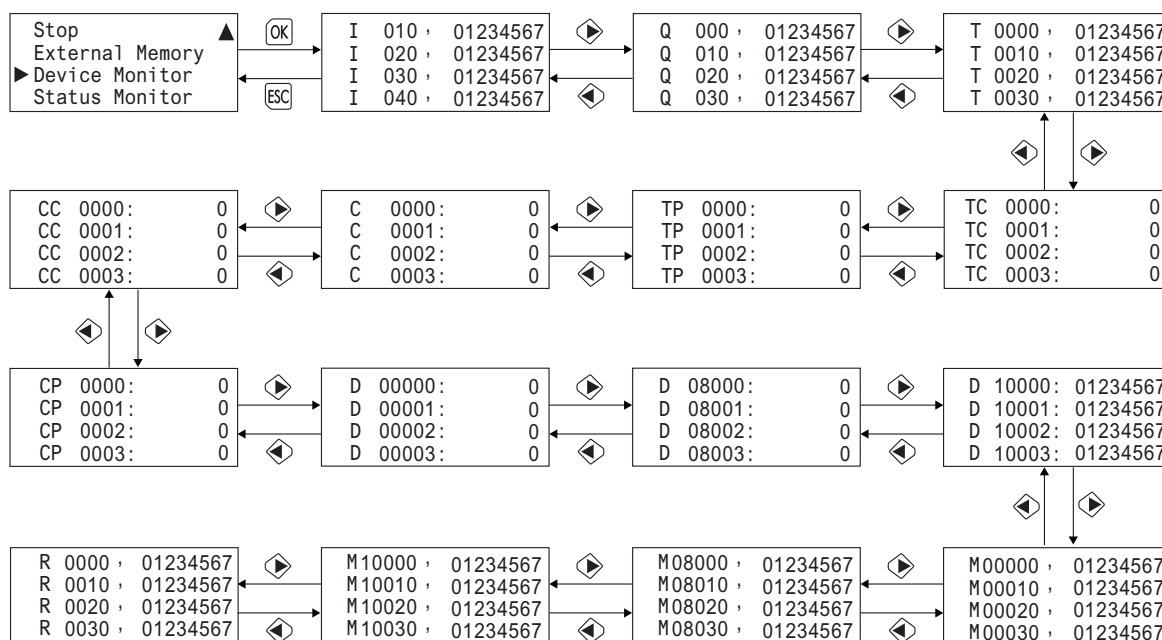

Monitoring the FC6A Series MICROSmart Status

⋮ is displayed only when the Plus CPU module is connected.

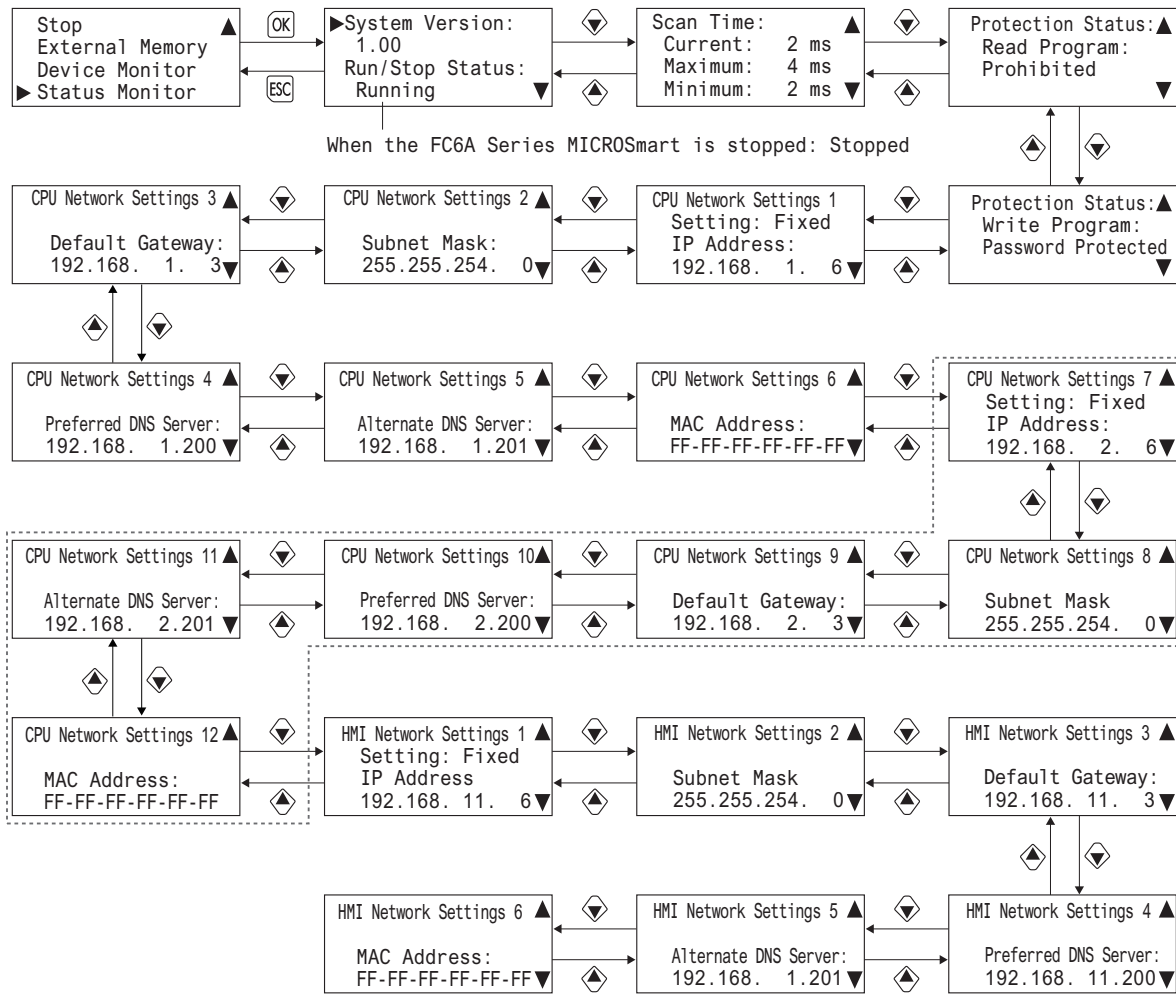

Checking/clearing error information

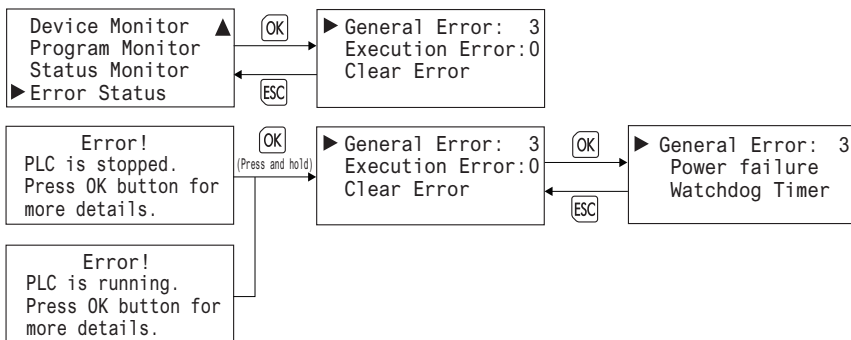

INDEX

- #
 - 1:1 Maintenance Communication System 1-14
 - 1:N Maintenance Communication System 1-14
 - 24V DC power type 2-21, 2-25, 2-26, 2-28, 2-58, 2-60, 2-61, 2-62
 - 2-edge count 5-20
 - 32-bit Data Storage 8-9
 - 4-edge count 5-20
- A
 - AC power type 2-11
 - ACT 2-148, 2-149
 - ACT LED 2-6, 2-10, 2-51, 2-148, 2-160
 - ACT1 LED 2-149
 - ACT2 LED 2-149
 - Adding counter 5-20
 - Adjust
 - function 5-63
 - advanced instruction
 - data types 8-7
 - input condition 8-6
 - list 8-3
 - NOP 8-11
 - structure 8-6
 - All-in-One CPU module 2-4
 - Analog I/O assignment 10-10
 - Analog I/O Cartridge 10-7
 - Analog I/O cartridge 1-4, 2-168
 - Analog I/O module 1-3, 9-1
 - Analog Input 2-6, 2-51
 - Analog input data type 5-44, 5-46
 - Analog input filter 5-44, 5-46
 - Analog port cover 2-6, 2-51
 - Analog Potentiometer 2-6, 2-51
- B
 - BACnet Communication 1-19
 - basic
 - instructions 8-1
 - BAT 2-5, 2-9, 2-50
 - Battery holder 1-6, 2-50, 2-5, 2-9
 - Battery status LED 2-5, 2-9, 2-50
 - Bluetooth communication cartridge 2-176
 - Borrow 6-9, 8-10
- C
 - Cable 1-5
 - cable A-16
 - Cable terminals 2-137, 2-128
 - Calendar & Clock 5-4
 - data storage locations 5-64
 - error 5-63
 - CAN J1939 All-in-One CPU module 2-7
 - CAN Ports 2-9
 - Carry 8-10
 - Carry/ 6-9
 - Carry/Borrow 6-9
 - Cartridge Base Module 1-2
 - Cartridge base module 2-162
 - Cartridge Slot 1 2-5, 2-8, 2-162
 - Cartridge Slot 2 2-5, 2-8, 2-162
 - Cartridge Slots 10-1
 - Character Code Table A-12
 - Checking
 - Error
 - Information 7-38
 - Checking Error Information from the System Menu 7-39
 - Checking the Version A-9
 - Clearing
 - Error
 - codes 13-2
 - Information 7-38
 - Clearing Data of FC6A Series MICROSmart 11-63
 - Clock
 - data
 - adjust flag M8021 5-63
 - Function 5-63
 - Communication
 - Functions 1-12
 - Ports 1-12
 - Communication Adapter Information 6-30
 - Communication cartridge 1-4, 2-173
 - Communication connector 2-6, 2-10, 2-51
 - Communication connector 1 2-162
 - Communication connector 2 2-162
 - Communication connector protection sticker 2-7, 2-10, 2-52, 2-162
 - Communication module 1-3
 - Communication modules 2-137
 - Comparison
 - Actions 5-21
 - ON status 5-27
 - Comparison output reset 5-28
 - Configuring the Network Settings 7-15
 - Configuring the Slave Number 7-14
 - confirm
 - password 5-59
 - Connector 1-5, 2-176, 2-164
 - Constant Scan Time 5-61
 - Control signal status 6-33
 - Count direction flag 5-28
 - counter
 - high-speed 5-15
 - Creating Device Address Data with Text Editor 11-60
 - Creating the autoexec.ini File 11-31
 - Creating the mqtt_basic_settings.ini File 11-39
 - Crimping tool 3-51
 - Current value
 - storage locations 5-27
 - D
 - data
 - storage setting
 - from lower word 5-56
 - from upper word 5-56
 - type 8-6
 - types for advanced instructions 8-7
 - Data File Manager 11-48
 - Daylight Savings Time 5-62
 - DC input specifications 2-21, 2-58
 - DC power type 2-12, 2-14, 2-53
 - decimal values and hexadecimal storage 8-7
 - destination device 8-6

details button *13-1*
 Device *6-1*
 device
 areas discontinuity *8-11*
 Device Settings *5-4*
 Digital I/O cartridge *1-4*
 Digital I/O cartridge parameters *10-4*
 Digital input and output assignments *10-3*
 Digital input specifications *2-165*
 Digital output specifications *2-166*
 Dimensions *2-177*
 Direct Addressing *8-12*
 direct mounting on panel surface *3-11*
 disable and enable interrupts *5-38, 5-49*
 disabling protection *5-59*
 discontinuity of device areas *8-11*
 download
 program *4-10*
 Download an MQTT Basic Settings File *11-46*
 Downloading and Uploading Device Address Data *11-60*
 Downloading Device Address Data *11-61*
 Downloading the User Program *7-45*
 Dummy Cartridges *2-6, 2-10*
 Dummy cartridges *2-162*

E

edit user program *4-4*
 Entering the password *7-43*
 Environment Settings *7-12*
 ERR *2-5, 2-9, 2-50, 2-147, 2-148*
 ERR LED
 during errors *13-4*
 error
 causes and actions *13-4*
 code
 user program execution *13-6*
 status box *13-1*
 Error LED *2-50, 2-147, 13-13, 2-5, 2-9, 2-148*
 Ethernet *1-17*
 Communication *1-17*
 Ethernet Port 1 *2-6, 2-9, 2-51*
 Ethernet port 1 *5-4*
 Ethernet Port 1 Cover *2-7, 2-10, 2-52*
 Ethernet port 2 *5-4*
 EtherNet/IP communication *1-20*
 Expander *2-143*
 Expansion *2-148*
 Expansion connector *2-5, 2-9, 2-50, 2-128, 2-137, 2-149*
 Expansion connector 1 *2-148*
 Expansion connector 2 *2-148*
 Expansion connector protection sticker *2-6, 2-10, 2-51*
 Expansion interface module *1-4, 2-143*
 Expansion port 1 Exp. port S1 *2-149*
 Expansion port 2 Exp. port S2 *2-149*
 Expansion port 2 Exp. port S2 cover *2-149*
 Expansion port Exp. port M *2-148*
 external input *5-40*

F

falling edge of catch input *5-36*
 Ferrule *3-46*
 File Format of mqtt_basic_settings *11-41*
 filter
 input *5-42*
 Fonts *A-12*

forced
 I/O *5-50*
 I/O status *5-50*
 Format SD memory card with the FC6A Series MICROSmart
 7-42
 Frequency Measurement *5-40*
 from
 lower word *5-56*
 upper word *5-56*
 Function
 Area Settings *5-3*
 List *5-1*
 Function specifications *2-138, 2-149, 2-176, 2-16, 2-55, 2-164*
 Function Switch *2-6, 2-10*
 Function switch *2-51*

G

General specifications
 DC power type *2-12, 2-14, 2-53*
 AC power type *2-11*
 Ground terminal *2-148*

H

hexadecimal storage decimal values *8-7*
 High-speed Counter
 External Inputs *5-16*
 high-speed counter *5-15*
 High-speed counter devices *5-27*
 HMI module *1-2, 2-160, 7-1*
 HSC
 reset input *5-28*

I

I/O
 forced *5-50*
 status *5-50*
 I/O cartridges *10-1*
 IN *2-50*
 Indirect Addressing *8-12*
 Input
 filter *5-42*
 Terminal
 Wiring *3-18*
 input
 condition for advanced instructions *8-6*
 Input Configuration *5-4*
 Input Filter *10-4*
 Input internal circuit *2-22, 2-24, 2-59, 2-71, 2-73, 2-99, 2-113, 2-132*
 Input LEDs *2-5, 2-9, 2-50*
 Input terminals *2-5, 2-9, 2-51*
 installation
 and wiring *3-1*
 location *3-1*
 Installed Fonts List *A-12*
 interrupt
 input *5-37*

K

keep
 data sum check Error *13-4*
 Keep Data Error *5-9*

L

LCD
 Backlight ON Time *7-13*
 LED indicators *2-4, 2-8, 2-49*
 AT *2-128*
 EVT *2-128*
 F/P *2-128*

- MT 2-128
- OUT 2-128
- PWR 2-127
- R/H 2-128
- R/L 2-128
- LINK LED 2-6, 2-10, 2-51, 2-147, 2-160
- LINK1 LED 2-148
- LINK2 LED 2-149
- list
 - advanced instruction 8-3
 - basic instruction 8-1
- LNK 2-147, 2-148, 2-149
- Log data file size 5-55
- M**
 - maintaining catch input 5-36
 - Maintenance
 - Communication 1-14, 11-1
 - Maximum Number of Modules and Slots to Install 2-139
 - Memory Backup 5-3, 5-13
 - Menu Screen 7-5
 - Message Screen 7-5, 7-40
 - Modbus
 - Communication 1-15
 - Model list 2-164
 - Modifying a Bit Device Value 7-33
 - Modifying a Word Device Value 7-34
 - Module Configuration Editor 12-1
 - monitor
 - operation 4-12
 - Monitoring
 - the FC6A Series MICROSmart Status 7-35
 - WindLDR 13-1
 - Monitoring Device Values 7-32
 - Mounting
 - hole layout
 - for direct mounting 3-12
 - Space 3-3
 - MQTT Communication 1-21
- N**
 - no operation 8-11
 - NOP 8-11
- O**
 - opcode 8-6
 - operating
 - status during errors 13-4
 - Operating ranges 2-22, 2-24, 2-58, 2-70, 2-72, 2-98
 - operation
 - basics 4-1
 - Operator Interface Connectivity 1-18
 - Optional Cartridge Information 6-30
 - Options 1-7, A-7
 - OUT 2-50
 - output
 - during errors 13-4
 - Output delay 2-25, 2-60, 2-82, 2-100
 - Output internal circuit 2-26, 2-27, 2-28, 2-29, 2-61, 2-62, 2-84, 2-86, 2-115, 2-133
 - Output LEDs 2-5, 2-9, 2-50
 - Output terminals 2-50, 2-6, 2-9
 - Overflow 5-28
- P**
 - Part names and functions 2-164
 - password 5-59
 - Password protected 5-58
 - PID module 1-3
 - PLC Selection 4-2
 - PLC status 13-1, 13-2
 - Plus CPU module 2-49
 - Port 1
 - Data link Communication 1-16
 - Modbus Communication 1-15
 - User Communication 1-15
 - power
 - failure 13-4
 - supply 3-20
 - Power LED 2-50, 2-137, 2-147, 2-5, 2-9, 2-148
 - Power supply precautions 2-151
 - Power supply specifications 2-53
 - Power supply terminals 2-51, 2-149, 2-6, 2-10
 - Power supply terminals cover 2-7, 2-10, 2-51
 - Precautions when supplying power 2-126, 2-136
 - Preset value, reset value
 - storage locations 5-21, 5-28
 - Program performance 2-134
 - programming
 - 32-bit data storage setting using WindLDR 5-57
 - catch input 5-35
 - forced I/O using WindLDR 5-52
 - input filter using WindLDR 5-42
 - interrupt input using WindLDR 5-38
 - timer interrupt using WindLDR 5-48
 - user program protection using WindLDR 5-58
 - Progression time error after power interruption 2-134
 - Prohibited 5-58
 - protection
 - user program 5-58
 - PWR 2-5, 2-9, 2-50, 2-127, 2-137, 2-143, 2-147, 2-148
- Q**
 - quit WindLDR 4-12
- R**
 - R1, R2 2-137
 - Rating at Max Surrounding Air Temperature of 55°C/65°C 2-186
 - read program 5-59
 - reading
 - error data 13-1
 - Receive LEDs 2-137
 - Recommended SD Memory Card 11-2
 - Relay output specifications 2-60, 2-25
 - Remote I/O 1-17
 - Remote master 2-147
 - Remote slave 2-148
 - removing
 - from DIN rail 3-11
 - repeat
 - cycles 8-6
 - designation 8-6
 - reset
 - input 5-5, 5-28
 - status 5-28
 - rising edge of catch input 5-36
 - rising/falling edge selection 5-35, 5-38
 - RS232C DSR Control Signal Status 6-34
 - RS232C DTR Output Control Signal Option 6-36
 - RUN 2-5, 2-9, 2-50, 2-148
 - Run LED 2-50, 13-12, 2-5, 2-9, 2-148
 - Run/Stop Control 5-3
 - run/stop selection

at power up 5-10
 Run/Stop Selection at Keep Data Error 5-9
 rung 4-3, 4-4
 Running 7-9

S

S1, S2 2-137
 Save Log Data 11-7
 Scroll Speed 7-28
 Scroll Unit 7-29
 SD 2-5, 2-9, 2-50
 SD Memory Card Configuration Dialog Box 11-22
 SD Memory Card Cover 2-6, 2-10, 2-51
 SD Memory Card Maintenance 11-48
 SD Memory Card Slot 2-6, 2-10, 2-50
 SD memory card status LED 2-5, 2-9, 2-50, 11-2
 SD Memory Card transfer error 13-5
 Self Diagnostic 5-4
 Sensor power terminals 2-5, 2-8
 Serial Port 1 2-6
 Serial Port 1 Cover 2-7
 Setting
 Calender/Clock 7-31
 Clock 5-63, 7-31
 simulate operation 4-9
 Single-phase high-speed counter 5-16, 5-18, 5-19
 source
 and destination devices 8-6
 device 8-6
 Special and Convenient Functions 5-1
 Special data register
 for error information 13-3
 for interrupt inputs 5-37
 for scan time 5-61
 for timer interrupt 5-48
 list 5-27
 Special data register device addresses 6-17
 Special Data Registers for the SD Memory Card 11-3
 Special internal relay
 for interrupt inputs 5-37
 for timer interrupt 5-48
 list 5-27
 Special internal relay device addresses 6-4
 Special Internal Relays for the SD Memory Card 11-3
 specifications
 catch input 5-35
 Standard Screen 7-5
 start
 WindLDR 4-1, 4-3
 Start/stop
 high-speed counter 5-27
 operation 4-18
 using power supply 4-19
 using WindLDR 4-18
 STAT 2-6, 2-9, 2-50
 Status LED 2-50, 2-6, 2-9
 Status of Support for Expanded Ambient Operating Temperatures (-25 to -10°C and 55 to 65°C) 2-2
 stop
 input 5-5
 Stopping 7-9
 Stopping Access to the SD Memory Card 7-41
 structure of an advanced instruction 8-6
 Supported Device Address 11-60

Supported Languages 1-8, A-12
 Switching to the System Menu 7-8
 System
 Menu
 Hierarchy Diagram 7-47
 program
 version D8029 13-1
 software
 upgrade A-9

T

terminal
 connection 3-45
 Terminal arrangement 2-64, 2-141, 2-34, 2-150
 Terminal name label 2-137
 Terminals 2-164
 Terminals for Terminal Blocks 3-45
 timer
 or counter
 as destination device 8-6
 as source device 8-6
 timer/counter
 preset value
 sum check error 13-4
 Transistor protection source output specifications 2-28, 2-62
 Transistor sink output specifications 2-26, 2-61
 Transmit LEDs 2-137
 troubleshooting 13-1
 diagrams 13-10
 Two-phase high-speed counter 5-16, 5-18, 5-19
 Type label 2-137, 2-127
 Type List A-1, A-12

U

Underflow 5-28
 Up/down selection reversible counter 5-20
 upgrade FC6A Series MICROSmart system software A-9
 Uploading Device Address Data 11-62
 Uploading the User Program 7-46
 USB Port 2-6, 2-10, 2-51
 USB Port Cover 2-7, 2-10, 2-51
 User
 Communication 1-15
 Program
 Protection 5-58
 user
 program
 Data Link Connection Error 13-4
 execution error 13-6
 keep data sum check error 13-4
 protection 5-58
 ROM sum check error 13-4
 syntax error 13-4
 writing error 13-5
 User Communication Cable 1C A-14
 User Program Execution Errors 8-10

V

via USB 13-25

W

watchdog timer error 13-4
 WindLDR
 programming
 input filter 5-42
 interrupt input 5-38
 timer interrupt 5-48
 user

program protection *5-58*
quit *4-12*
start *4-1, 4-3*
Windows Displayed in the Workspace *4-13*
wiring *3-1*
Wiring arrangement and wiring examples *2-167*
write program *5-59*

IDEC CORPORATION

 www.idec.com

Head Office
6-64, Nishi-Miyahara-2-Chome, Yodogawa-ku, Osaka 532-0004, Japan

USA	IDEC Corporation	Tel: +1-408-747-0550	opencontact@idec.com	Hong Kong	IDEC Izumi (H.K.) Co., Ltd.	Tel: +852-2803-8989	info@hk.idec.com
Germany	APEM GmbH	Tel: +49-40-25 30 54 - 0	service@eu.idec.com	China/Shanghai	IDEC (Shanghai) Corporation	Tel: +86-21-6135-1515	idec@cn.idec.com
Singapore	IDEC Izumi Asia Pte. Ltd.	Tel: +65-6746-1155	info@sg.idec.com	China/Shenzhen	IDEC (Shenzhen) Corporation	Tel: +86-755-8356-2977	idec@cn.idec.com
Thailand	IDEC Asia (Thailand) Co., Ltd	Tel: +66-2-392-9765	sales@th.idec.com	China/Beijing	IDEC (Beijing) Corporation	Tel: +86-10-6581-6131	idec@cn.idec.com
Australia	IDEC Australia Pty. Ltd.	Tel: +61-3-8523-5900	sales@au.idec.com	Japan	IDEC Corporation	Tel: +81-6-6398-2527	marketing@idec.co.jp
Taiwan	IDEC Taiwan Corporation	Tel: +886-2-2577-6938	service@tw.idec.com				

Specifications and other descriptions in this brochure are subject to change without notice.
2020 IDEC Corporation, All Rights Reserved.

B-1722(16) DECEMBER 2020

